



Philips Healthcare

Medical Supplies Reference Guide

Dear Customer:

If you're looking for high-quality medical supplies to optimize the performance of your medical devices, you'll find them right here. Whether your focus is on quality patient care, reliability, or cost containment, you can turn to a single source -- Philips Medical Supplies. Explore our complete family of supplies, from electrodes to SpO₂ sensors, for every area of care.

With Philips, you can buy your medical equipment and supplies from a single source, simply and easily. Use this Reference Guide to find the Philips supplies you need -- or go to our website to purchase supplies: <http://shop.medical.philips.com>

Using This Guide:

This guide is designed for those who need a comprehensive list of Philips medical supplies. The guide categorizes all of the medical supplies currently available from Philips Medical Systems. It provides information such as product descriptions, weights, packaging configurations and associated instruments. (All information in this guide is subject to change at any time without notice.)

Related Documents:

The following Medical Supplies catalogs are also available to you:

- Diagnostic ECG and Ultrasound Imaging
- Critical Care Monitoring
- OB and Neonatal Monitoring
- Resuscitation

Contact your local Philips sales representative for ordering and return information specific to your country. If you'd like to provide feedback on this guide, please fax your comments to (978) 659-7712.

Using This Guide	v
Latex Cautions	v
CE Marking	v
Ordering Information	v
Online Ordering	v
Warranty Information	vi
Place of Performance	vi
Limitation of Warranty	vi
Limitation of Remedies and Liability	vi
Chapter 1: Electrodes	1-1
Disposable Adult Monitoring Electrodes	1-2
Disposable Neonatal and Pediatric Monitoring Electrodes	1-4
Cardiography Electrodes	1-7
Reusable Limb Plate Electrodes	1-9
Limb Plate Straps	1-10
EEG Electrodes	1-11
Chapter 2: Paper	2-1
Paper Selection Guide	2-2
Recording Paper for Philips Instruments	2-6
Chapter 3: Cables and Lead Sets	3-1
ECG Lead Set Placement Guide	3-2
Philips CMS ECG Safety Cables and Leads Selection Guide	3-2
Philips New ECG Cables and Leads Selection Guide	3-4
Philips New ECG Monitoring Cable and Lead System	3-10
ECG Cable Accessories	3-23
Radiolucent ECG Lead Sets	3-25
SureSigns VM4, VM6, VM8 ECG Cables and Leads	3-26
A1/A3/C1 ECG Cables and Leads	3-27
ICG Cable for Non-Invasive Hemodynamic Monitoring	3-27
Telemetry	3-28
Defibrillator ECG Patient Cables and Leads	3-35
Diagnostic ECG Trunk Cables	3-37
Diagnostic ECG Lead Sets	3-38
Diagnostic ECG Replacement Leads	3-40
Diagnostic ECG Cable Accessories	3-43
EEG Cables and Lead Sets	3-45
MIDA Cables and Leads	3-46
Chapter 4: Fetal Monitoring Supplies	4-1
Fetal Direct ECG Monitoring	4-2
Disposable Belts	4-7
Reusable Belts	4-8
Fetal Belt Buttons and Guides	4-10
Intrauterine Pressure (IUP) Products	4-11
Fetal Monitoring Paper	4-13
Ultrasound Supplies	4-15
Miscellaneous Supplies	4-15
Fetal Monitoring Kits	4-16
Chapter 5: Invasive Blood Pressure Supplies	5-1
Memscap Pressure Transducers	5-2
Blood Pressure Kits	5-3
Chapter 6: Non-Invasive Blood Pressure Supplies	6-1
Reusable NIBP Cuffs: Latex-Free	6-2
Disposable NIBP Cuffs: Latex-Free	6-13

NIBP Interconnect Tubing	6-17
NIBP Cuff Adapters	6-19
Neonatal NIBP Cuffs: Latex Free	6-21
Neonatal Interconnect Tubing	6-22
Chapter 7: Temperature Probes	7-1
Disposable Temperature Probes-Continuous Monitoring (Latex-Free)	7-2
Reusable Temperature Probes-Continuous Monitoring (Latex-Free)	7-6
Predictive Temperature Monitoring	7-7
Chapter 8: Gas Monitoring Supplies	8-1
Transcutaneous Gas Monitoring Supplies	8-2
Mainstream CO ₂	8-3
Sidestream CO ₂ Monitoring Supplies	8-4
Spirometry CO ₂ /Flow	8-9
Anesthetic Gas Supplies	8-10
Bispectral Index™ (BIS) Sensors	8-12
Chapter 9: SpO₂ Monitoring	9-1
Reusable SpO ₂ Sensors and Accessories	9-2
Disposable SpO ₂ Sensors and Accessories	9-7
Chapter 10: Ultrasound Imaging Supplies	10-1
Ultrasound Imaging Supplies	10-2
TEE Supplies	10-3
Imaging Paper	10-5
Chapter 11: Miscellaneous Supplies	11-1
Batteries	11-2
Miscellaneous Supplies	11-4
Stethoscope Parts	11-6
Chapter 12: Defibrillator/AED Supplies	12-1
DEFIBRILLATOR SUPPLIES/ACCESSORIES	12-2
External Pads and Cables	12-2
Pad Adapters	12-4
Adapter Cable Test Loads	12-4
External Paddle Sets	12-5
Replacement Electrodes	12-5
Internal Paddles	12-6
Sync Cables	12-7
Defibrillator Batteries/Cases/Accessories	12-8
HeartStart MRx Accessories	12-9
Q-CPR™ Compression Sensor	12-10
Data Management Solutions	12-11
AED SUPPLIES AND ACCESSORIES	12-12
AED Pads and Accessories	12-12
AED Data Management Solutions	12-15
AED Cases and Wall Mount Solutions	12-17
AED Training Materials	12-20
Chapter 13: Cardiac Output	13-1
Invasive Cardiac Output	13-2
Non-Invasive Cardiac Output	13-3

Using This Guide

Latex Cautions

Philips Medical Supplies currently distributes over 600 products, of which less than 9% contain natural rubber latex or dry natural rubber that could contact humans. Because these substances may cause allergic reactions, products in this guide that contain them are identified with the following symbol:

LATEX

Caution: Products that are identified with this symbol contain dry natural rubber or natural rubber latex that can come into contact with humans and may cause allergic reactions.

To the best of our knowledge, products not identified with this symbol are not known to contain natural rubber latex or dry natural rubber. The latex symbol indicates **only** which **medical supplies** contain natural rubber latex or dry natural rubber that can come into contact with humans and may cause allergic reactions. If you want to know whether a Philips **medical device** contains natural rubber latex or dry natural rubber, refer to the product labeling.

The FDA requires that products be labeled with human contacting latex content information when appropriate. Always refer to product labeling for accurate information on human contacting dry natural rubber or natural rubber latex.

CE Marking

Products labeled with this symbol conform to the European Union (EU) directives as mandated by EU member state legislation and are available for sale in Europe to countries that accept CE marking with restrictions as may be noted. Medical devices labeled with this marking means the product is in conformity with the European Medical Directive (MDD): 93/42/EEC Council Directive of 14 June 1993 on the approximation of the laws of the Member States concerning medical

devices.

In order for a product to be able to be labeled with the CE marking, product quality and manufacturing quality systems must be documented to comply with certain standards. Compliance with the European directives and regulations ensures a standard level of performance for device function, safety, and health protection for users, patients, and others.

The CE symbol provided with some products in the Philips Medical Supplies Reference Guide and online store is intended only as an indication of availability in EU countries and is not intended as a legal product marking.

Countries that accept CE marked products include Austria, Belgium, Bulgaria, Cyprus, Czech Republic, Denmark, Estonia, Finland, France, Germany, Greece, Hungary, Iceland, Ireland, Italy, Latvia, Liechtenstein, Lithuania, Luxembourg, Malta, Netherlands, Norway, Poland, Portugal, Romania, Russia, Slovakia, Slovenia, Spain, Sweden, Switzerland, Turkey and the United Kingdom. A CE mark does not necessarily indicate that a product is marketed or distributed in all of the countries listed above.

Non-medical products that comply with other harmonized directives may also bear the CE mark.

Each Philips medical product that is labeled with the CE marking is identified with one of the following symbols:

CE

CE₀₃₆₆

CE₀₁₂₃

Other manufacturers' CE marking symbols may include but not limited to:

CE₀₃₆₆

Ordering Information

To order the medical supplies in this guide or to obtain more information or additional literature, contact your Philips Medical Supplies representative near you or visit our website: <http://shop.medical.philips.com>

Online Ordering

Online ordering is a simple process:

- 1 Log in using a secure password.
- 2 Enter the product number and quantity in the shopping cart.
- 3 Enter your PO or credit card number at check-out.
- 4 Your order is immediately transferred into our fulfillment system, where you can track it anytime.

If you are new to the web, we can guide you through the process on the phone in minutes. Many new users tell us that the ordering process is so intuitive that they do not need help, even the first time.

You can search for supplies in the online catalog three easy ways: by application category, Philips instrument, or keyword.

If you currently transmit via MMS/EDI or auto fax, the interactive system provides real-time information and services not available through one-way transmissions.

Online ordering is available to U.S. customers at the following url: <http://shop.medical.philips.com>.

Warranty Information

Philips Medical Supplies Guarantee

Philips Medical is committed to your satisfaction. That's why we guarantee our supplies products against defects in materials and workmanship for a minimum of one year or the balance of the product's shelf life.*

If any of our products proves unsatisfactory during the guarantee period, just let us know. We'll either refund the purchase price or replace the defective product.

We'll ask you to tell us what went wrong, so we can fix the problem and ensure your satisfaction.

* Some products have guarantees longer than one year. For further information and a complete statement of warranty terms and conditions, contact your local Philips Medical Supplies representative.

Place of Performance

Products must be returned to a service facility designated by Philips. Contact your local Philips Sales Office for information on where to return products. The customer shall prepay shipping charges (and shall pay all duty and taxes) for products returned to Philips for warranty service. Except for products returned to the customer from another country, Philips shall pay for return of products to the customer.

Limitation of Warranty

The foregoing warranty shall not apply to defects resulting from any of the following:

- Improper or inadequate maintenance by the customer
- Customer-supplied software or interfacing hardware
- Unauthorized modification or misuse
- Operation outside of the environmental specifications for the product
- Improper site preparation and maintenance

The warranty set forth herein is exclusive and no other warranty, whether written or oral, is expressed or implied.

Philips specifically disclaims the implied warranties of merchant ability and fitness for a particular purpose.

Limitation of Remedies and Liability

The remedies provided herein are the customer's sole and exclusive remedies. In no event shall Philips be liable for direct, indirect, special incidental, or consequential damages (including loss of profits) whether based on contract, tort, or any other legal theory.

The foregoing limitation of liability shall not apply in the event that any Philips product sold hereunder is determined by a court of competent jurisdiction to be defective and to have directly caused bodily injury, death, or property damage, provided that in no event shall Philips liability for property damage exceed the greater of \$50,000 (U.S.) or the purchase price of the specific product that caused such damage.



Chapter 1 Electrodes

For Information About	See Page
Disposable Adult Monitoring Electrodes	1-2
Disposable Neonatal and Pediatric Monitoring Electrodes	1-4
Cardiography Electrodes	1-7
Reusable Limb Plate Electrodes	1-9
Limb Plate Straps	1-10
EEG Electrodes	1-11

Our Disposable Electrodes are suitable for use on all manufacturers' adult ECG monitors that comply with ANSI/AAMI ECG monitoring standards.

Products labeled with a CE mark indicates compliance with the EU Medical Devices Directive.

Disposable Adult Monitoring Electrodes

Adult Monitoring Electrodes for ECG

Product Number	Electrode Size	Description	Packaging Information		Use for	
40493D CE See photo	2-1/8" diameter	Silver/silver-chloride (Ag/AgCl) sensor, foam, pre-gelled. Recommended for the OR, ER, ICU.	5/pack 300 electrodes/case	Pkg. wt. = 3 lb (1.36kg)	Shelf life: At least 6 months Shelf life: At least 6 months	All adult ECG monitoring
40493E CE See photo			30/pack 300 electrodes/case	Pkg. wt. = 1 lb 13oz (822g)		
M4612A CE See photo	Teardrop shape 2" (50mm) diameter	Disposable, foam, solid adhesive gel, snap electrode. Silver/silver chloride (Ag/AgCl) sensor. Ideal for short or medium term monitoring in the ICU and CCU.	5/pack 300 electrodes/case	Pkg. wt. = 2.5 lb (1.2kg)		
M4613A CE See photo			30/pack 300 electrodes/case	Pkg. wt. = 1.5 lb (.69kg)		
9898031 48801	Rectangular 1.6" x 1.26" (41mm x 32mm)	Disposable, foam, solid adhesive gel. Sized for smaller adults.	30/pack 1500 electrodes/case (Available in U.S. & Japan)	Pkg. wt. = 5.9 lb (2.72kg)		
9898031 48811	Square 1.3" x 1.3" (34mm x 34mm)	Disposable, cloth, solid adhesive gel. Sized for smaller adults.	30/pack 450 electrodes/case (Available in U.S. & Japan)	Pkg. wt. = 2.5 lb (1.2kg)		
9898031 48821	Oval shape 1.4" x 1.6" (43mm x 36mm)	Disposable, radiolucent foam, solid adhesive gel. Sized for smaller adults.	30/pack 600 electrodes/case (Available in U.S. & Japan)			
M4606A CE	Skin Prep Paper		10 preps/sheet 100 preps/bag	Pkg. wt. = 1 oz (0.04kg)	Use to prep skin for electrodes.	



40493D/40493E

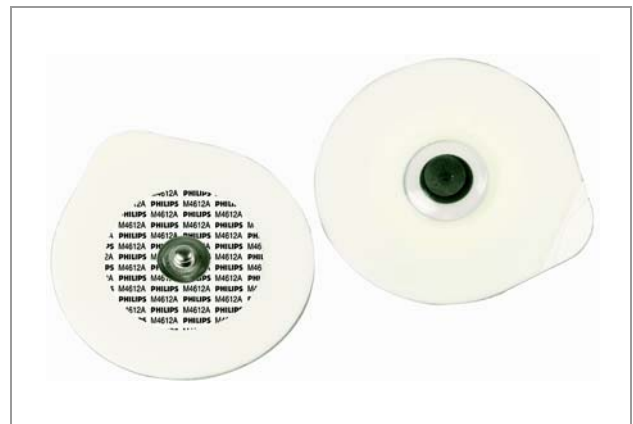

M4612A/M4613A

Adult Monitoring Electrodes for ECG (continued)

Product Number	Description	Dimensions	Packaging Information		Use for
M2202A CE See photo	Disposable radiolucent foam electrode for use where X-rays will be used. Silver/silver-chloride (Ag/AgCl) sensor, non-metallic snap, pre-gelled. MR SAFE	2" (50mm) diameter	5/pack 300 electrodes/ case	Pkg. wt. = 2 lb 13oz (1.28kg)	All adult ECG monitoring and MR Systems 1.0T, 1.5T, 3.0T
13941E CE	Disposable cloth, wet gel electrode for long-term and holter monitoring. Contains non-allergenic skin balance gel. Silver/silver-chloride (Ag/AgCl) sensor.	2-1/8" (54mm) diameter	30/pack 300 electrodes/ case	Pkg. wt. = 1 lb 15oz (879g)	
13942E CE	Disposable, pre-gelled electrode with clear plastic tape. Ideal for stress testing and monitoring. Contains non-allergenic skin balance gel. Silver/silver-chloride (Ag/AgCl) sensor.	2-1/8" (54mm) diameter	30/pack 300 electrodes/ case	Pkg. wt. = 2 lb 1oz (936g)	All adult ECG monitoring
40489E CE See photo	Disposable, pre-gelled electrode with paper tape. Recommended for ECG monitoring while performing ultrasound procedures. Silver/silver-chloride (Ag/AgCl) sensor.	2-3/8" (59mm) diameter		Pkg. wt. = 1 lb 14oz (850g)	



M2202A



40489E

Disposable Neonatal and Pediatric Monitoring Electrodes

Metallic Leadwire Electrodes

U.S. (AAMI Color Coding)

Product Number	Description	Electrode Size/ Dimensions	Safety Socket Size/ Color	Packaging Information	Use with Philips Instrument
13952A	Disposable cloth, solid-gel electrodes with pre-attached 18" (46cm) non-shielded, copper lead wires. Silver/silver chloride (Ag/AgCl) sensor, repositionable.	Medium (rectangular) 7/8" x 1-1/4" (22mm x 33mm)	1.5mm (black) Use with Philips safety cables	3/pack 300 electrodes/ case	Pkg. wt. = 2 lb 9oz (1.3kg) Shelf life: At least 6 months
13953A See photo		Small (square) 7/8" x 7/8" (22mm x 22mm)			

Metallic Leadwire Electrodes

EUROPE (IEC Color Coding)

Product Number	Description	Electrode Size/ Dimension	Safety Socket Size/ Color	Packaging Information	Use with Philips Instrument
13952D CE	Disposable cloth, solid-gel electrodes with pre-attached 18" (46cm) non-shielded, copper lead wires. Silver/silver chloride (Ag/AgCl) sensor, repositionable.	Medium (rectangular) 7/8" x 1-1/4" (22mm x 33mm)	1.5mm (black) Use with Philips safety cables	3/pack 300 electrodes/ case	Pkg. wt. = 2 lb 9oz (1.3kg) Shelf life: At least 6 months
13953D CE See photo		Small (square) 7/8" x 7/8" (22mm x 22mm)			

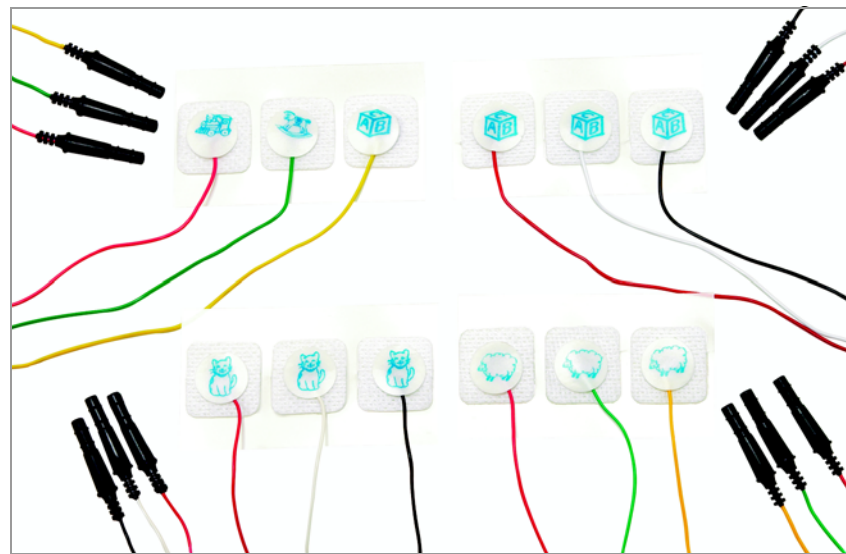

13953A, 13953B, 13953D, 13953E

Radiolucent Leadwire Electrodes

U.S. (AAMI Color Coding)

Product Number	Description	Electrode Size/ Dimension	Safety Socket Size/Color	Packaging Information		Use with Philips Instrument
13952B	Disposable cloth, solid-gel electrodes with pre-attached 18" (46cm) non-shielded, radiolucent carbon leads. Silver/silver chloride (Ag/AgCl) sensor, repositionable.	Medium (rectangular) 7/8" x 1-1/4" (22mm x 33mm)	1.5mm (black) Use with Philips safety cables	3/pack 300 electrodes/case	Pkg. wt.= 2 lb 6 oz (1.2kg)	Neonatal/ pediatric monitors
13953B See Photo		Small (square) 7/8" x 7/8" (22mm x 22mm)			Shelf life: At least 6 months	

Radiolucent Leadwire Electrodes

EUROPE: (IEC Color Coding)

Product Number	Description	Electrode Size/ Dimension	Safety Socket Size/ Color	Packaging Information		Use with Philips Instrument
13952E CE	Disposable cloth, solid-gel electrodes with pre-attached 18" (46cm) non-shielded, radiolucent carbon leads. Silver/silver chloride (Ag/AgCl) sensor, repositionable.	Medium (rectangular) 7/8" x 1-1/4" (22mm x 33mm)	1.5mm (black) Use with Philips safety cables	3/pack 300 electrodes/ case	Pkg. wt.= 2 lb 6oz (1.2kg)	Neonatal/ pediatric monitors
13953E CE See Photo		Small (square) 7/8" x 7/8" (22mm x 22mm)			Shelf life: At least 6 months	

Wet-gel and Solid-gel Electrodes

Product Number	Description	Electrode Size/ Dimension	Packaging Information	Use with Philips Instrument
13950B CE See photo	Disposable, cloth, wet gel, snap electrode. Silver/silver chloride (Ag/AgCl) sensor, repositionable.	Round 1-1/4" (32mm) diameter	30 individually wrapped electrodes per box, 10 boxes/case Shelf life: At least 6 months	Neonatal/ pediatric monitors
13951C CE See photo	Disposable, cloth, solid gel, snap electrode. Silver/silver chloride (Ag/AgCl) sensor, repositionable.	Rectangular 7/8" x 1-1/4" (22mm x 33mm)	30 electrodes per pack, 300/case	
13955C CE		Square 7/8" x 7/8" (22mm x 22mm)		



13950B



13951C

Cardiography Electrodes

Disposable Diagnostic Cardiography Electrodes for Resting ECG

Product Number	Description	Electrode Size/ Dimension	Packaging Information	Use with Philips Leadwire Adapters	
13943B CE See photo	High performance, tab style, solid gel electrode for resting ECG. Silver/silver chloride (Ag/AgCl) sensor.	1-3/8" x 7/8" (35mm x 22mm)	100/pack 1000 electrodes/ case	Pkg. wt. = 1 lb 5oz (595g) Shelf life: At least 6 months	40431B 40432B M2254A
M2253A CE See photo	Tab style, solid gel electrode for resting ECG. Silver/silver chloride (Ag/AgCl) sensor. Alternative to 13943B tab electrode. Not available in Japan.	1-1/4" x 3/4" (33mm x 20mm)	100/pack 1000 electrodes/ case	Pkg. wt. = 1 lb 8oz (672g) Shelf life: At least 6 months	40431B 40432B M2254A
9898031 49901 CE	Pediatric tab style, solid gel electrode for resting ECG. Silver/silver chloride (Ag/AgCl) sensor.	Rectangular 1.38" x 9/16" (14mm x 34mm)	10 electrodes per card, 10 cards per pack, 1000/case	Pkg. wt. = .540 kg Shelf life: At least 6 months	40431B 40432B M2254A
40420A CE See photo	High performance, snap style, pre-gelled foam electrode for resting ECG's. Silver/silver chloride (Ag/AgCl) sensor.	2-1/2" x 1-1/8" (65mm x 28mm)	100/pack 1000 electrodes/ case	Pkg. wt. = 7 lb (3.18kg) Shelf life: At least 3 months	40475A 40498E
13944B CE See photo	Snap-style, wet-gel, foam electrode for resting ECG. Silver/silver chloride (Ag/AgCl) sensor.	1-3/4" x 1-1/8" (45mm x 28mm)	10/pack 300 electrodes/ case	Pkg. wt. = 1 lb 7oz (652g) Shelf life: At least 6 months	

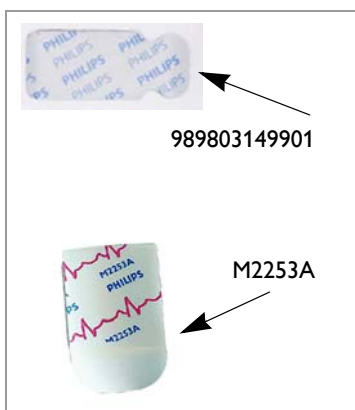

Tab Electrodes



40420A



13944B

Reusable Welsh-Bulb Electrodes

Product Number	Description	Dimension	Connector Type	Packaging Information	
40418A LATEX See photo	Welsh electrode with shoulder screw connection.	Not available in Europe	5cc bulb, reusable, cup diameter = 15mm	1/8" post cable end	1 box = 6 electrodes Pkg. wt. = 7oz (198g)
40421A LATEX	Welsh electrode with push-in connector for 1/8" post cable end.				
40490E LATEX CE See photo	Welsh electrode with push-in connector for 4mm banana plug cable end.	Recommended for Europe	Reusable 5cc bulb. Cup diameter = 15mm	4mm banana plug cable end	1 box = 1 electrode Pkg. wt. = 1oz (28g)

Replacement Bulbs for Welsh-Bulb Electrodes

Product Number	Description	Packaging Information	Use with Philips Electrodes
40419A LATEX	Adult size replacement bulb for all 15mm diameter electrodes. Bulb volume is 5cc.	1 box = 12 bulbs	40418A 40421A 40490E
40422A LATEX	Small size replacement bulb for all 15mm diameter electrodes. Bulb volume is 2cc.		



40418A



40490E

Reusable Limb Plate Electrodes

Limb Plate Electrodes

Product Number	Description		Packaging Information		Use With Philips Electrodes
40424A See photo	Limb plate electrode for push-in type connection. Nickel-silver, push-in connector.	Not available in Europe	1 box = 4 electrodes	Pkg. wt. = 2oz (57g)	All cardiographs with standard 1/8" post end leads
40491E CE	Limb plate electrode for 4mm banana plug leads. Push-in connector.	Recommended for Europe	1 ziplock bag = 4 electrodes	Pkg. wt. = 1oz (28g)	All cardiographs with standard 4mm banana plug leads
40494E CE See photo	Limb clamp electrode, clothespin type, for 1/8" post end leads or 4mm banana plug leads, screw connector.			Pkg. wt. = 10oz (283g)	All cardiographs with standard 1/8" post end leads or 4mm banana plug leads

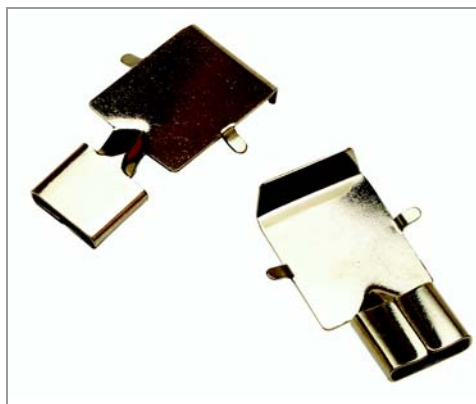

40424A



40494E

Limb Plate Straps

Reusable Straps

Product Number	Description	Packaging Information	Use with Philips Electrodes
14030A CE See photo	15" (38cm) rubber strap for attaching limb electrode.	1 box = 4 straps	40424A 40425A 40491E

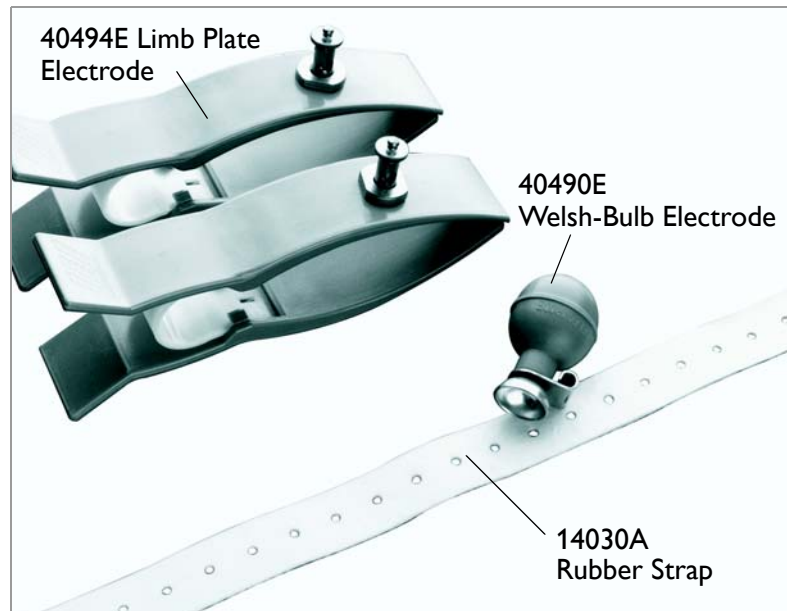

EEG Electrodes

Reusable EEG Electrodes

Product Number	Description	Packaging Information		Use with Philips Instrument
M1931A CE See photo	10 mm silver/silver chloride reusable leadwired adult cup electrode.	1 pack = 1 lead set	Pkg. wt. = 3.2oz (90g)	M1027A Module
M1932A CE	6 mm silver/silver chloride reusable leadwired pediatric cup electrode.			
M1937A	EEG conductive adhesive paste used to apply reusable electrodes.	1 tube	Pkg. wt. = 3.5 lb (100g)	

Disposable EEG Electrodes

Product Number	Description	Packaging Information		Use with Philips Instrument
M1935A CE See photo	40 mm (1.57") diameter, foam, silver/silver chloride disposable, pre-gelled EEG snap electrode. Can also be used for ECG monitoring,	25 wet gel electrodes/pack 100 electrodes/case	Pkg. wt. = 11.2oz (314g)	M1027A Module

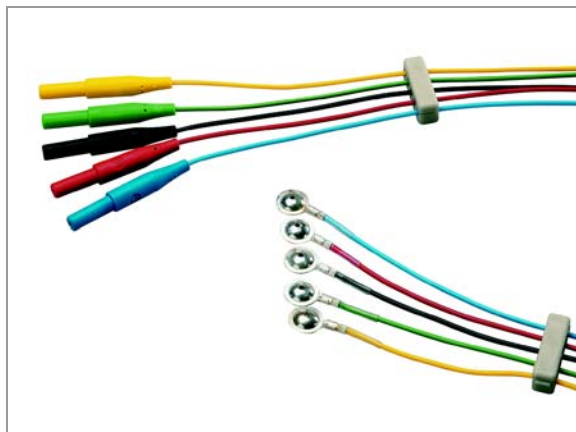

M1931A



M1935A

Notes



Chapter 2

Paper

For Information About	See Page
Paper Selection Guide	2-2
Recording Paper for Philips Instruments	2-6

Products labeled with a CE mark indicates compliance with the EU Medical Devices Directive.

Paper Selection Guide

Products listed in the Paper Selection Guide may have CE markings. To determine the CE marking status, see the specific product information that follows the Paper Selection Guide.

Adult Monitors and Central Station

IF you have any of these Philips instruments or systems	THEN you may use any of these papers	Description
78173A/W	40453A	1-ch chem/therm, 40mm grid, rolls
78560A (original recorder)	40457C/D	1-ch chem/therm, 40mm grid, rolls
78560A (upgraded recorder)	40477A/B	Unprinted chem/therm, rolls
M1205A- with M1117A	40469A	Multi-channel thermal array, Z-fold
M2340A, M2350A, M2360A:- with M1117A	40469A	
M1116A/B, M1122A, M3176B recorders M3001A	40477A/B	Unprinted chem/therm, rolls
M1117A	40469A	Multi-channel thermal array, Z-fold
M1118A	M1885A	Unprinted multi-channel, Z-fold (A4)
A1/C1 Recorder: M3925A A3 Series: M3927A, M3929A, C3 Series: 862475, 862479 M3176C: USB 2-Channel Recorder	M4816A	Chem/therm, 10 rolls
	M4817A	Chem/therm, 80 rolls
M3160A Recorder	PSE11268	4-channel thermal recording paper
ICG Monitor 862146	989803138131	Thermal paper, 20 rolls
VS1, VS3, VM4, VM6, VM8	989803136891	Thermal array, 5 rolls

Defibrillators

IF you have any of these Philips instruments or systems	THEN you may use any of these papers	Description
43100A 43110A 43110M/MC 43120A 43200A 78660A/B 78661A/B 78670A 78671A	40453A	1-ch chem/therm, 40mm grey grid, 10 rolls
M1722A/B M1723A/B M2475B M3500B M4735A M5500B M3535A M3526A/J	40457C 40457D	1-ch chem/therm, 40mm grid, 10 rolls 1-ch chem/therm, 40mm grid, 80 rolls
M3535A, M3536A/J Opt. B04 (75 mm printer)	989803138171 989803138181	1-ch chem/therm, 65mm grid, 10 rolls 1-ch chem/therm, 65mm grid, 80 rolls

Ultrasound Imaging Systems Recorders

Recorder Manufacturer	Philips Recorder Product Number	System or Philips 770XXA Imaging System Option	Manufacturer Recorder Product Number	Manufacturer Paper Product Number	Philips Paper Product Number
Kowa	77510A	C80 thru C85 M2424A	TLR 111	KRP10-002A	40479A
Mitsubishi	77570A 77570B	C70, C71	P70, P72	K70S	40458A

Fetal Monitors

IF you have any of these Philips instruments or systems	THEN you may use any of these papers	Description
8025A/B 8030A/8031A/8032A 8232A/B, 8040A/ 8041A	40470A	Green Grid, 50-210 FHR scale, 1 min. highlights, 40 packs
8020A 8021A 8025A/B 8030A 8031A 8032A 8040A 8041A	9270-0484 9270-0485 9270-0630-050	Green Grid, 50-210 FHR scale, no highlights, 40 packs Orange Grid, 30-240 FHR scale, 1 min. highlights, 40 packs Green Grid, 50-210 FHR scale, kPa scale, no highlights, 50 packs
M1350A M1351A M1353A M2702A/M2703A	M1910A M1911A M1913A M1913J	Orange Grid, 30-240 FHR scale, 1 min. highlights, 40 packs Green Grid, 50-210 FHR scale, kPa scale no highlights, 40 packs Green Grid, 50-210 FHR scale, 1 min. highlights, 40 packs Green Grid, 50-210 color coded FHR scale, 1 min. highlights, 40 packs

Fetal Monitor Paper Characteristics Reference

Fetal Heart Rate Scale	Color of Grid	Includes 1minute (3cm) Highlights?	Includes kPa Scale for Europe?	FMR Filing System (optional)	Product Number	Packs per Case	Use with Philips Monitors
50-210	green	yes	no	M4503A	40470A	40	8025A/B 8030A 8031A 8032A 8232A/B 8040A 8041A
30-240	orange	yes	no		9270-0485	40	8020A
50-210	green	no	no		9270-0484	40	8021A/B 8025A/B
50-210	green	no	yes		9270-0630-050	50	8030A 8031A 8032A 8040A 8041A
30-240	orange	yes	no		M1910A	40	M1350A/B/C
50-210	green	no	yes		M1911A	40	M1351A M1353A
50-210	green	yes	no		M1913A	40	M2922A M2702A M2703A
50-210	green	yes	no		M1913J	40	M1350A/B M1351A M1353A M2702A M2703A

Cardiographs, ECG Management Systems, and Recorders

IF you have any of these Philips instruments or systems	THEN you may use any of these papers	Description
M1700A M1701A M1702A (PageWriter XL)	M1707A M1708A M1709A M1710A M2481A M2483A M2485A M2486A M2206A M2207A	8½" x 11" Z-fold, red grid, 7.3cm header 8½" x 11" Z-fold, red grid, no header A4 (210mm x 297mm) Z-fold, red grid, 6.7cm header A4 (210mm x 297mm) Z-fold, red grid, no header 8½" x 11" Z-fold, red grid, 7.3cm header A4 (210mm x 297mm) Z-fold, red grid, 6.7cm header Anti-fade 8½" x 11" Z-fold, red grid, 7.3cm header Anti-fade A4 (210mm x 297mm) Z-fold, red grid, 6.7cm header Anti-fade 8½" x 11" Z-fold, red grid, 7.3cm header Anti-fade A4 (210mm x 297mm) Z-fold, red grid, 6.7cm header
M1770A M1771A M1772A (PgWr 300/200/100), 860284 (PgWr. Touch)	M2481A M2483A M2485A M2486A	8½" x 11" Z-fold, red grid, 7.3cm header A4 (210mm x 297mm) Z-fold, red grid, 6.7cm header Anti-fade 8½" x 11" Z-fold, red grid, 7.3cm header Anti-fade A4 (210mm x 297mm) Z-fold, red grid, 6.7cm header
M1730A/B 5630I 43610B 860281	M1737A M1738A	8½" x 11" laser printer, red grid, 7.3cm header A4 (210mm x 297mm) laser printer, red grid, 6.7cm header
860286 860287 860288 860290 (PageWriter Trim)	M3707A M3708A	8½" x 11" Z-fold, red grid, 7.3cm header A4 (210mm x 297mm) Z-fold, red grid, 6.7cm header
CBD2000A (Cambridge Heart)	CBD20257	Stress Chart Paper, 8½" x 11" Z-fold, red grid, no header
860295 (StressVue)	989803137011 989803143031	Stress Chart Paper, 8½" x 11" Z-fold, red grid, no header Stress Chart Paper, A4 (210mm x 297mm) Z-fold, red grid, no header

Recording Paper for Philips Instruments

Paper for Monitoring Recorders

Product No.	Description		Packaging Information		Use With:
M1885A CE	Multi-channel blank chem/therm array recorder paper, Z-fold. Pages numbered.	A4 format (210mm x 300mm)	500 sheets/ pack 1 case = 6 packs = 3000 sheets	Pkg. wt. = 25lb 4oz (11.45kg)	M1118A Recorder only
40469A	Multi-channel thermal array recorder paper, unprinted, Z-fold pack.	Length = 147' (44.8m) 5-15/16" x 4-3/4" (150mm x 120mm)	300 sheets/ pack 1 case = 20 packs	Pkg. wt. = 15 lb (6.8kg)	M1117A Recorder
40477A CE	Thermal array recorder module paper, unprinted.	Length = 98' (29.9m) Roll width = 1.97" (50mm)	1 box = 10 rolls	Pkg. wt. = 2 lb (907g)	M1116A/B M3176B Recorder module
40477B CE			1 case = 8 packs = 80 rolls	Pkg. wt. = 17 lb (7.71kg)	
M4816A CE	Thermal array recorder paper.	Length = 98' (29.9m) Roll width = 1.97" (50mm)	10 rolls/box	Pkg. wt. = 2 lb (907g)	M3925A Recorder for A1/C1, M3176C USB, A3/C3 Recorder
M4817A CE			1 case = 8 boxes = 80 rolls	Pkg. wt. = 17 lb (7.71kg)	
PSE11268	Seiko 4-channel recorder paper for IntelliVue Information Center System.	Length = 328' (100m) Roll width = 3" (112mm)	1 case = 20 rolls	Pkg. wt. = 31 lb (14.06kg)	M3160A Recorder
9898031 36891	Thermal array recorder paper	Length = 100' (30.5m) Roll width= 2.3" (5.8cm)	1 box = 5 rolls	Pkg. wt. = 1.6 lb (480g)	VS1, VS3, VM4, VM6, VM8 Integrated recorder
9898031 38131	ICG Integrated thermal array recorder paper	Length= 19.6' (6m) Roll width= 2.5" (6.35cm)	1 box = 20 rolls	Pkg. wt. = 1 lb (.490kg)	862146 ICG Monitor with integrated recorder



40477A/B

Fetal Monitoring Recording Paper

Product Number	Description	Packaging Information			Use with Fetal Monitors
40470A	Green grid with 1-min. (3cm) highlights. 0-100 mmHg IUP scale, 50-210 FHR scale.	Fetal monitoring chem/therm paper, with “Stop” sign on last page. 3-15/16” x 5-15/16” (100mm x 151mm) Pages numbered.	150 pages/ pack 1 case = 40 packs	Pkg. wt. = 11 lb (4.99 kg)	8025A/B 8030/1/2A 8232A/B 8040/1A
9270–0484 Photo next page	Fetal monitoring chem/therm paper, with “Stop” sign on last page. Green grid with 0-100 mmHg IUP scale, 50-210 FHR scale. Pages numbered.	150 pages/pack 3-15/16” x 5-15/16” (100mm x 151mm)	1 case = 40 packs	Pkg. wt. = 11lb 1oz (5.02kg)	8030A 8031A 8040A 8041A 8232A/B
9270–0485	Orange grid with 1-min. (3cm) highlights. 0-100 mmHg IUP scale, 30-240 FHR scale.				
9270–0630– 050	Fetal monitoring chem/therm paper, with “Stop” sign on last page. Green grid with 0-100 mmHg scale, plus 0-13 kPa scale, 50-210 FHR scale. Pages numbered.	150 pages/pack 3-15/16” x 5-15/16” (100mm x 100mm)	1 case = 5 boxes = 50 packs	Pkg. wt. = 17 lb 1oz (7.74kg)	8030A 8031A 8040A 8041A
M1910A ☼ Photo next page	Fetal monitoring chem/therm paper with “Stop” sign on last page. Orange grid with 1-min. (3cm) highlights. 0-100 mmHg IUP scale, 30-240 FHR scale.	150 sheets/ pack 1 case = 40 packs	1 case = 40 packs	Pkg. wt. = 11lb 3oz (5.07kg)	M1350A/B/C M1351A M1353A M2702A M2703A M2925A (recorder)
M1911A ☼ Photo next page	Fetal monitoring chem/therm paper with “Stop” sign on last page. Green grid with 0-100 mmHg IUP scale, plus 0-13 kPa scale, 50-210 FHR scale.				
M1913A	Fetal monitoring chem/therm paper with “Stop” sign on last page. Green grid with 1-min. (3cm) highlights. 0-100 mmHg IUP scale, 50-210 FHR scale.				

M1910A

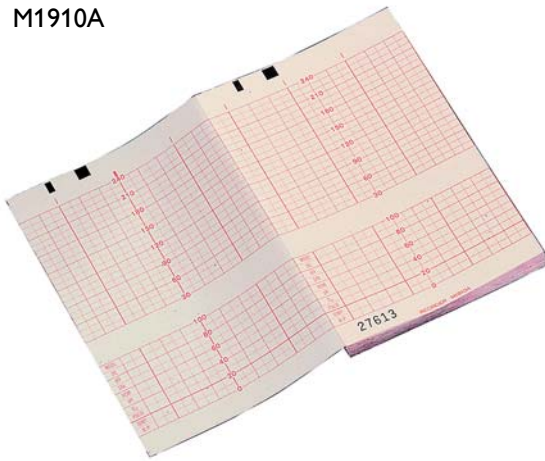

M1911A

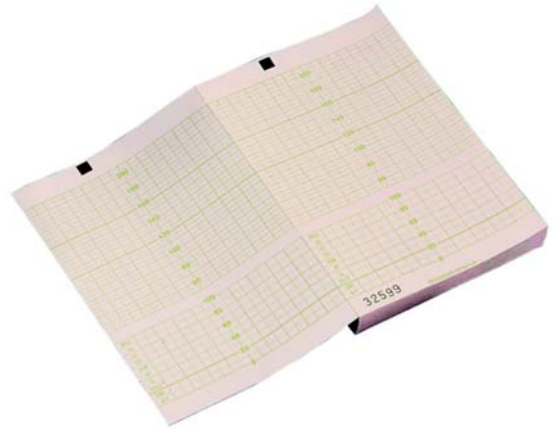

9270-0484

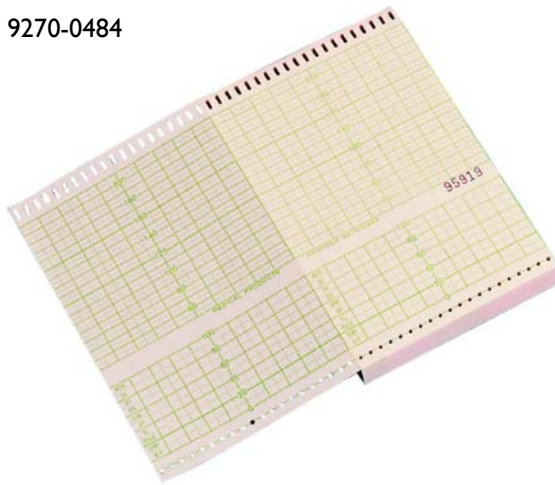

Recording Paper for Defibrillators

Product Number	Description		Packaging Information		Use with Philips Instrument
40453A CE	1-channel chem/ therm, 40mm grid, critical margin=8mm.	Length = 100' (30.5m) Roll width = 2" (50mm)	1 box = 10 rolls	Pkg. wt. = 2 lb (907g)	43100A 43110A 43120A 78173A/W 78660A/B 78661A/B 78670A 78671A
40457C CE		Critical margin = 1/4" (6mm)			
40457D CE	1-channel chem/ therm, gray 40mm grid.	Length = 100' (30.5m) Roll width = 2" (50mm)	1 case = 8 boxes = 80 rolls	Pkg. wt. = 18 lb (8.16kg)	
9898031 38171 CE	1-channel chem/ therm, red 65mm grid.	Critical margin = 0.4" (10mm) Length = 100' (30.5m) Roll width = 2.98" (75.4mm)	1 box = 10 rolls	2.9lb (1.3kg)	M3535A M3536A/J
9898031 38181 CE			1 box = 80 rolls	23.5lb (10.7kg)	HeartStart MRx Option B04 (75mm printer)

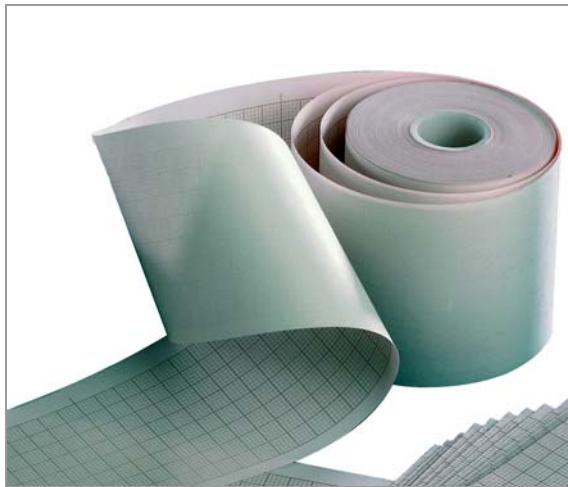

40457C/D



9898031 38171

Recording Paper for Cardiographs, ECG Management Systems

Product Number	Description	Packaging Information		Use with Philips Instrument	
CBD20257	Cambridge Heart Stress Chart Paper	300 sheets/ream 8-1/2" x 11"	1 case = 10 reams	Pkg. wt. = 32 lb (14.3kg)	CBD2000A
M1707A CE See photo	PageWriter XL thermal paper, Z-fold, with 2-7/8" (7.3cm) header, red grid.	8-1/2" x 11" (216mm x 279mm)	1 case = 8 packs = 1600 sheets	Pkg. wt. = 18 lb 6oz (8.33kg)	M1700A M1701A M1702A
M1708A	PageWriter XL thermal paper, Z-fold, with no header, red grid.	A4 Europe format (210mm x 297mm)	1 case = 8 packs = 1600 sheets	Pkg. wt. = 18 lb 5oz (8.31kg)	
M1709A CE	PageWriter XL thermal paper, metric, Z-fold, with 6.7cm header, red grid.			Pkg. wt. = 18 lb 10oz (8.45kg)	
M1710A CE	PageWriter XL thermal paper, metric, Z-fold with no header, red grid.			Pkg. wt. = 19 lb 4oz (8.73kg)	
M1737A CE	Preprinted with red grid and 2.4" (60mm) header. For printing ECG's from a laser printer.	8-1/2" x 11" (216mm x 279mm)	1 case = 10 packs = 5000 sheets	Pkg. wt. = 52 lb 1oz (23.62kg)	860281 (TraceMaster View)
M1738A CE		A4 format (210mm x 297mm)	1 case = 10 packs = 5000 sheets	Pkg. wt. = 45 lb 14oz (20.81kg)	M1730A ECG Management System 56301 REALM/ Vectra 43610B ECG Workstation
M2206A CE	PTP-brand anti-fade thermal paper for PageWriter XL, Z-fold, with 2-7/8" (7.3cm) header, red grid.	8-1/2" x 11" (216mm x 279mm)	1 case = 8 packs = 1600 sheets	Pkg. wt. = 16 lb 11oz (7.57kg)	M1700A M1701A M1702A
M2207A CE	PTP-brand anti-fade thermal paper for PageWriter XL, Z-fold, with 6.7cm header, red grid.	A4 Europe format (210mm x 297mm)		Pkg. wt. = 17 lb 7oz (7.91kg)	

Product Number	Description	Packaging Information			Use with Philips Instrument
M2481A CE	PageWriter thermal paper, Z-fold, with 2-7/8" (7.3cm) header, light red grid.	8-1/2" x 11" (216mm x 279mm)	1 case S= 16 packs = 1600 sheets	Pkg. wt. = 18 lb 6oz (8.33kg)	M1700A M1701A M1702A PageWriter XL Series M1770A M1771A M1772A PageWriter 300/200/100 860284 PageWriter Touch
M2483A CE	PageWriter thermal paper, Z-fold, with 6.7cm header, light red grid.	A4 Europe format (210mm x 297mm)		Pkg. wt. = 18 lb 10oz (8.45kg)	
M2485A CE	PTP-brand anti-fade thermal paper for PageWriter, Z-fold, with 2-7/8" (7.3cm) header, light red grid.	8-1/2" x 11" (216mm x 279mm)		Pkg. wt. = 16 lb 11oz (7.57kg)	
M2486A CE	PTP-brand anti-fade thermal paper for PageWriter, Z-fold, with 6.7cm header, red grid.	A4 Europe format (210mm x 297mm)		Pkg. wt. = 17 lb 7oz (7.91kg)	
M3707A CE	PageWriter thermal paper, Z-fold, with 2-7/8" (7.3cm) header, light red grid.	8-1/2" x 11" (216mm x 279mm)		Pkg. wt. = 18 lb 6oz (8.33kg)	
M3708A CE	PageWriter thermal paper, Z-fold, with 6.7cm header, light red grid.	A4 Europe format (210mm x 297mm)			
9898031 37011 9898031 43031 CE	StressVue thermal paper, Z-fold, red grid, no header	8-1/2" x 11" A4 Europe format	1 case = 12 packs = 3000 sheets	Pkg. wt. = 33.6 lb (15.25kg)	860295 StressVue Cardiac Stress System

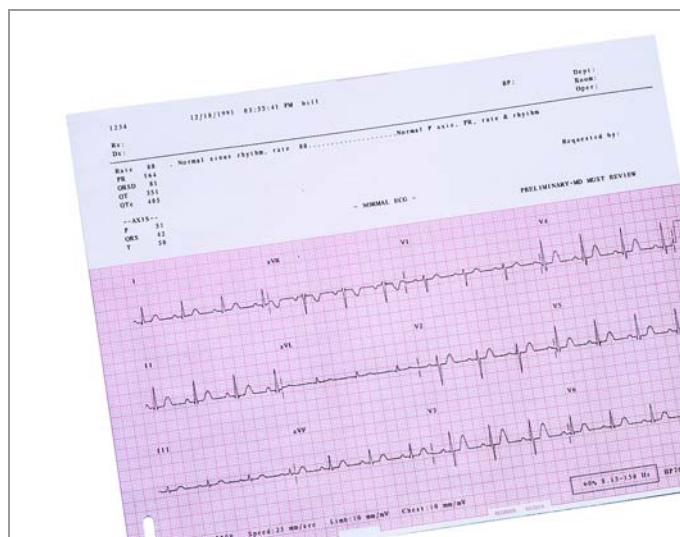

M1707A

Recording Paper for Ultrasound Imaging Recorders

Product Number	Description		Packaging Information		Use with Philips Instrument
40479A	Plasticized thermal strip chart recorder paper.	Roll length = 131' (40m) Roll width = 6" (152mm)	1 box = 4 rolls	Pkg. wt. = 4lb (1.81kg)	77510A strip chart recorder
40458A	Plasticized thermal video imaging paper.	Roll length = 70' (21m) Roll width = 8-1/2" (216mm)	1 box = 4 rolls	Pkg. wt. = 3lb (1.36kg)	77570A/B

Notes



Chapter 3

Cables and Lead Sets

For Information About	See Page
ECG Lead Set Placement Guide	3-2
Philips CMS ECG Safety Cables and Leads Selection Guide	3-2
Philips New ECG Cables and Leads Selection Guide	3-4
Philips New ECG Lead Sets	3-9
10-Lead ECG Patient Cable Sets (5 + 5 Leads)	3-10
10-Lead ECG Patient Cable Sets (6 + 4 Leads)	3-13
6-Lead ECG Patient Cable Sets for 6-Lead Monitoring	3-15
5-Lead ECG Patient Cable Sets for Standard 5-Lead Monitoring	3-17
3-Lead ECG Patient Cable Sets for Standard 3-Lead Monitoring	3-20
ECG Cable Accessories	3-23
Radiolucent ECG Lead Sets	3-25
SureSigns VM4, VM6, VM8 ECG Cables and Leads	3-26
A1/A3/C1 ECG Cables and Leads	3-27
ICG Cable for Non-Invasive Hemodynamic Monitoring	3-27
Telemetry	3-28
Defibrillator ECG Patient Cables and Leads	3-35
Diagnostic ECG Lead Sets	3-38
Diagnostic ECG Replacement Leads	3-40
Diagnostic ECG Cable Accessories	3-43
EEG Cables and Lead Sets	3-45
MIDA Cables and Leads	3-46

Products labeled with a CE mark indicates compliance with the EU Medical Devices Directive.

ECG Lead Set Placement Guide

AAMI and IEC color coding

Type	North America (ANSI/AAMI EC13/IEC60601-2-27:2005 Code 2)		Europe (IEC 60601-2-27:2005 Code 1)	
	Lettering	Color	Lettering	Color
Right arm	RA	White	R	Red
Left arm	LA	Black	L	Yellow
Chest	V	Brown	C	White
Right leg	RL	Green	N	Black
Left leg	LL	Red	F	Green

3-lead sets contain right arm, left arm, and left leg leads. All are the same length and are short (1m, 3.3 ft).

5-lead sets contain all 5 leads. Right arm, left arm, and chest leads are short (1m, 3.3 ft). Right leg and left leg leads are long (1.6m, 5.3 ft).

Philips CMS ECG Safety Cables and Leads Selection Guide

U.S. (AAMI Color Coding)

(FUTURE OBSOLESCENCE: refer to page 3-4 for replacement)

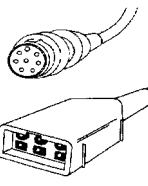
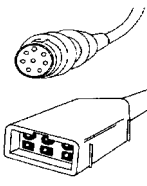
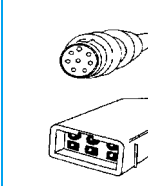
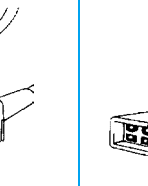
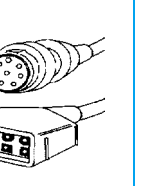
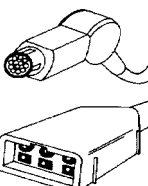
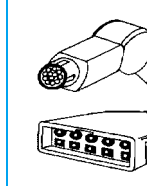
Philips Instruments with 5-Pin Connector		Philips Instruments with 8-Pin Connector				Philips Instruments with 12-Pin Connector	
78834C 78850A	7802D 78202B/C 78203A/C 78211A 78212A/D 78213A/C 78260A 78261A	77000AC 77020A/AC 77020AR 77025A 77030A 77035A 77040A 78208A 78210A 78211A 78330A 78331A 78332A 78333A 78341A 78342A 786xx series	78345A 78346A 78351T 78352A 78353A/B 78354A 78532A/B 78534A/B/ C M1722A/B M1723A/B M2400A M2406A M2475B M3500B M5500B	78208A 78210A 78330A 78331A 78332A 78333A 78341A 78342A 78345A 78346A 78351A 78352A 78353AB 78354AB	78346A 78351T 78352A 78353A 78354A 78532A/B 78534A/B/C M1722A/B M3500B M5500B	M1500A 78352C 78354C 78834C M1001A/B M1002A/B M1722A/B M1723A/B M2475B M3000A, M3001A M3535A, M3536A M4735A M1540C M1001B, M1002B M3000A M3001A 862474, 862475 (C3) 862478, 862479 (C3)	M1520A 78352C 78354C 78834C M1001A/B M1002A/B M1722A/B M2475A M3000A M3001A M3535A M3536A M4735A M1560C M1001B M1002B M3000A M3001A
							
M1620A 9' (2.7m)	M1640A 9' (2.7m)	M1580A 9' (2.7m)	M1600A 9' (2.7m)	M1500A 9' (2.7m)	M1540C 2.9' (0.9m)	M1520A 9' (2.7m)	M1560C 2.9' (0.9m)

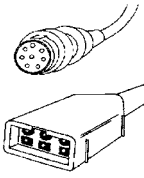
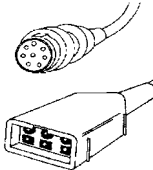
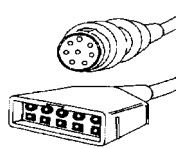
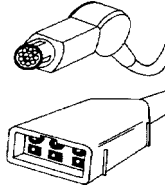
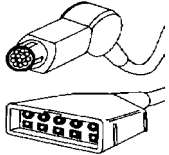

Europe (IEC Color Coding)

(FUTURE OBSOLESCENCE: refer to page 3-4 for replacement)

Philips Instruments with 5-Pin Connector	Philips Instruments with 8-Pin Connector		Philips Instruments with 12-Pin Connector			
78834C 78850A	77010AC 77020A 77020AC 77020AR 77025A 77030A 77035A 77040A 78208A 78210A 78330A 78331A 78332A 78333A 78341A 78342A	78345A 78346A 78351T 78352A 78353A 78353B 78354A 78532A 78532B 78534A 78534B/C M1722A/B M1723A/B M2400A M2406A M2475B M3500B M5500B	78208A 78210A 78330A 78331A 78332A 78333A 78341A 78342A 78345A	78346A 78351T 78352A 78353A 78354A 78532A/B 78534A/B/C M1722A/B M1723A/B M2475B M3000A, M3001A M3535A, M3536A M4735A M5500B	M1510A 78352C 78354C 78834C M1001A/B M1002A/B M1722A/B M1723A/B M2475A M2475B M3000A, M3001A M3535A, M3536A M4735A 862474, 862475 (C3) 862478, 862479 (C3) M1550C M1001B, M1002B M3000A, M3001A 862474, 862475 (C3) 862478, 862479 (C3)	M1530A 78352C 78354C 78834C M1001A/B M1002A/B M1722A/B M2475A M3535A M3536A M4735A M3000A M3001A M1570C M1001B M1002B M3000A M3001A
						
M1630A 9' (2.7m)	M1590A 9' (2.7m)	M1610A 9' (2.7m)	M1510A 9' (2.7m)	M1550C 2.9' (0.9m)	M1530A 9' (2.7m)	M1570C 2.9' (0.9m)

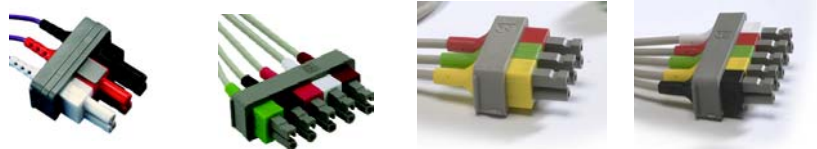
Philips CMS Lead Sets (FUTURE OBSOLESCENCE: see Philips new cable solution on page 3-4)

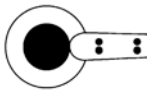
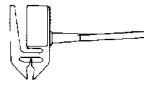
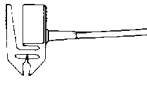
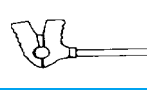

Connector Type	3-Lead (AAMI)	5-Lead (AAMI)	3-Lead (IEC)	5-Lead (IEC)
 Snap (shielded)	M1605A	M1625A	M1615A	M1635A
 Grabber (shielded)	M1603A	M1623A	M1613A	M1633A
 Grabber (OR use) (shielded)* (orange wires)	M1601A	M1621A	M1611A	M1631A
 Mini-Clip (non-shielded for neonatal use)	M1608A (.45m) M1609A (.7m)	M1629A	M1619A	M1639A
 Grabber (unshielded) (radiolucent)	M1649A (AAMI and IEC for 3 and 5 lead monitoring with CMS trunk cables) Packaged with 5 individual wires.			

*Grabber terminated OR lead sets have built-in ESU filters and are designed for use in the OR. Respiration cannot be measured.

If you have this monitoring device:	Use Philips New Trunk Cable (Product Number)	With one of Philips New Lead Sets (Product Number)	To replace Philips Old Trunk Cable and Lead Sets
6-Lead Trunk Cable (12-pin connector)			
M8102A MP2 Monitor M8105A MP5 Monitor M3001A Intellivue Multi-Measurement Module M3002A IntelliVue MMS X2	M1667A Length: 9' (2.7m) Note: The monitoring equipment must be configured for full 6-Lead functionality. The M1667A 6-Lead Trunk Cable can also be used for standard 3 and 5-Lead monitoring with the new 3-Lead or 5-Lead sets.	M1680A (ICU grabber, limb) M1682A (ICU snap, limb) M1684A (OR grabber, limb)	

U.S. (AAMI Color Coding)

If you have this monitoring device:	Use Philips New Trunk Cable (Product Number)	With one of Philips New Lead Sets (Product Number)	To replace Philips Old IntelliVue Trunk Cable
10-Lead Trunk Cable: 5-Lead + 5-Lead (12-pin connector)			
M8102A MP2 Monitor M8105A MP5 Monitor M3001A Intellivue Multi-Measurement Module M3002A IntelliVue MMS X2 M3535A/M3536A HeartStart MRx Defibrillator/Monitor	M1663A Length: 6.5' (2m) Note: The monitoring equipment must be configured for full 10-Lead functionality to take conventional diagnostic 12-lead. The M1667A 10-Lead Trunk Cable can also be used for standard 5-Lead monitoring with the new 5-Lead sets.	M1968A (ICU grabber, limb) M1976A (ICU grabber, chest) M1644A (ICU snap, limb) M1602A (ICU snap, chest) M1973A (OR grabber, limb) M1979A (OR grabber, chest)	M1949A
10-Lead Trunk Cable: 6-Lead + 4-Lead (12-pin connector)			
M8102A MP2 Monitor M8105A MP5 Monitor M3001A Intellivue Multi-Measurement Module M3002A IntelliVue MMS X2	M1665A Length: 9' (2.7m) Note: Note: The monitoring equipment must be configured for full 10-lead functionality to take conventional diagnostic 12-lead. The M1667A 10-Lead Trunk Cable can also be used for standard 5-Lead monitoring with the new 5-Lead sets.	M1680A (ICU grabber, limb) M1532A (ICU grabber, chest) M1682A (ICU snap, limb) M1537A (ICU snap, chest) M1684A (OR grabber, limb) M1557A (OR grabber, chest)	6-Lead = limb 4-Lead = chest









Europe (IEC Color Coding)

If you have this monitoring device:	Use Philips New Trunk Cable (Product Number)	With one of Philips New Lead Sets (Product Number)	To replace Philips Old Trunk Cable	and Philips Lead Sets	
3-Lead Trunk Cable (12-pin connector)					
M1001A/B, M1002A/B ECG Modules	M1669A Length: 9' (2.7m)	M1672A (ICU grabber)	M1510A	M1613A	
M3000A/M3001A Multi-Measurment Modules		M1674A (ICU snap)	M1550C	M1615A	
M3002A IntelliVue MMS X2		M1678A (OR grabber)		M1611A	
M8102A MP2 Monitor		M1626A (Mini, 0.7m, grabber)*		M1619A	
M8105A MP5 Monitor					
863063, 863064, 863065, 863066, 863068, 863077 SureSigns VM3, VM4, VM6, VM8			*excluding defibrillators		
M4735A HeartStart XL Defibrillator/Monitor					
M3535A/M3536A HeartStart MRx					
78352C, 78354C, 78834C Legacy HP Patient Monitors					

Europe (IEC Color Coding)

If you have this monitoring device:	Use Philips New Trunk Cable (Product Number)	With one2 of Philips New Lead Sets (Product Number)	To replace Philips Old IntelliVue Trunk Cable
10-Lead Trunk Cable: 5-Lead + 5-Lead (12-pin connector)			
M8102A MP2 Monitor M8105A MP5 Monitor M3001A Intellivue Multi-Measurement Module M3002A IntelliVue MMS X2 M3535A/M3536A HeartStart MRx Defibrillator/Monitor	M1663A Length: 6.5' (2m) Note: The monitoring equipment must be configured for full 10-lead functionality to take conventional diagnostic 12-lead. The M1667A 10-Lead Trunk Cable can also be used for standard 5-lead monitoring with the new 5-lead sets.	M1971A (ICU grabber, limb) M1978A (ICU grabber, chest) M1645A (ICU snap, limb) M1604A (ICU snap, chest) M1974A (OR grabber, limb) M1984A (OR grabber, chest)	M1949A
10-Lead Trunk Cable: 6-Lead + 4-Lead (12-pin connector)			
M8102A MP2 Monitor M8105A MP5 Monitor M3001A Intellivue Multi-Measurement Modules M3002A IntelliVue MMS X2	M1665A Length: 9' (2.7m) Note: The monitoring equipment must be configured for full 10-lead functionality to take conventional diagnostic 12-lead. The M1665A 10-Lead Trunk Cable can also be used for standard 5-lead monitoring with the new 5-lead sets.	M1681A (ICU grabber, limb) M1533A (ICU grabber, chest) M1683A (ICU snap, limb) M1538A (ICU snap, chest) M1685A (OR grabber, limb) M1558A (OR grabber, chest)	6-Lead = limb 4-Lead = chest

Philips New ECG Lead Sets

		3-Lead	5-Lead	6-Lead	4-Lead
Connector Type					
	Snap (shielded)	(AAMI) M1673A (IEC) M1674A	(AAMI) M1644A, M1602A (IEC) M1645A, M1604A	(AAMI) M1682A (IEC) M1683A	(AAMI) M1537A (IEC) M1538A
	Grabber (shielded)	(AAMI) M1671A (IEC) M1672A	(AAMI) M1968A, M1976A (IEC) M1971A, M1978A	(AAMI) M1680A (IEC) M1681A	(AAMI) M1532A (IEC) M1533A
	Grabber (OR) (shielded, orange-colored head) Grabber terminated OR lead sets have built-in ESU filters and are designed for use in the OR. Respiration cannot be measured.	(AAMI) M1675A (IEC) M1678A	(AAMI) M1973A, M1979A (IEC) M1974A, M1984A	(AAMI) M1684A (IEC) M1685A	(AAMI) M1557A (IEC) M1558A
	Mini-Clip (non-shielded) Mini-Clip lead sets for neonatal use.	(AAMI) M1622A, M1624A (IEC) M1626A	(AAMI) M1647A (IEC) M1648A	n/a	n/a
	Grabber (unshielded) (radiolucent)	M1649A (AAMI and IEC for 3 and 5 lead monitoring with Philips trunk cables: M1668A and M1669A . Packaged with 5 individual wires.			

Philips New ECG Monitoring Cable and Lead System

10-Lead ECG Patient Cable Sets (5 + 5 Leads)

10-Lead Trunk Cable

- Leads to be ordered in pairs of: M1968A/M1976A; M1644A/M1602A; M1973A/M1979A; M1971A/M1978A; M1645A/M1604A; M1974A/M1984A for conventional diagnostic 12-lead ECG.

Product Number	Description	Packaging Information		Use with Philips Instrument
M1663A AAMI & IEC CE I	10-lead ECG trunk cable with 12-pin ECG input connector. AAMI and IEC labels included. Length: 6.5' (2m)	1 cable	Pkg. wt. = 11oz (0.300kg)	78352C, 78354C, 78834C Legacy HP Monitors, Modules M1001A/B, M1002A/B M3001A Opt. C12 or Opt. C18 IntelliVue Multi- Measurement Modules M3002A Opt. C12 MMS X2 M8102A Opt. C12 MP2 Monitor
M1949A AAMI & IEC CE I	10-lead ECG trunk cable with 12-pin ECG input connector. AAMI and IEC labels included. Length: 8.9' (2.7m)			M8105A Opt. C12 MP5 Monitor M3535A/M3536A HeartStart MRx Defibrillator/Monitor

5-Lead Sets for the M1663A Trunk Cable

U.S. (AAMI Color Coding)

Product Number	Description	Packaging Information		Use with Philips Trunk Cable
M1968A photo next page	ICU grabber, limb	1 lead set	Pkg. wt. = 4oz (0.110kg)	Use M1663A or M1949A 10-lead trunk cable.
M1976A photo next page	ICU grabber, chest	1 lead set	Pkg. wt. = 4oz (0.110kg)	
M1644A photo next page	ICU snap, limb	1 lead set	Pkg. wt. = 8oz (0.214kg)	
M1602A photo next page	ICU snap, chest	1 lead set	Pkg. wt. = 9oz (0.250kg)	
M1973A photo next page	OR grabber, limb	1 lead set	Pkg. wt. = 4oz (0.100kg)	
M1979A photo next page	OR grabber, chest	1 lead set	Pkg. wt. = 4oz (0.100kg)	

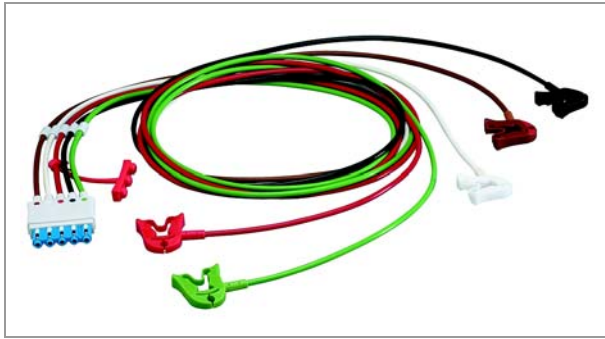

M1968A

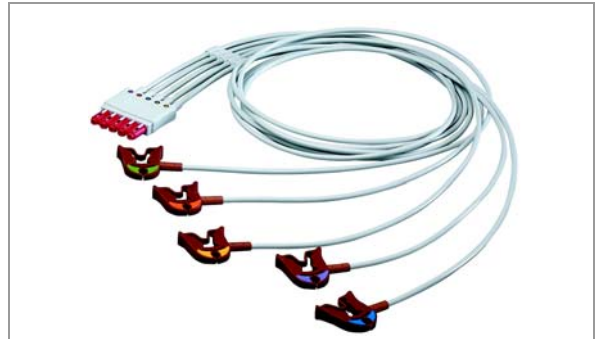

M1976A

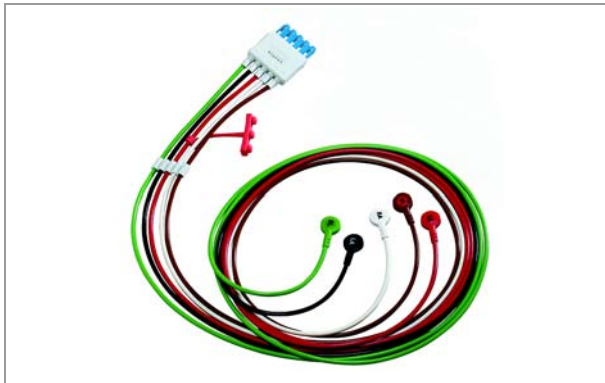

M1644A

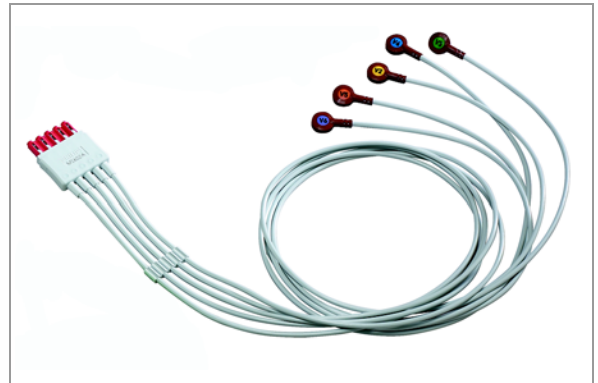

M1602A

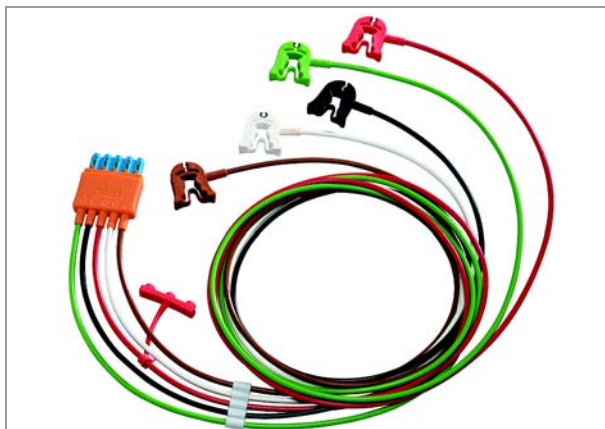

M1973A

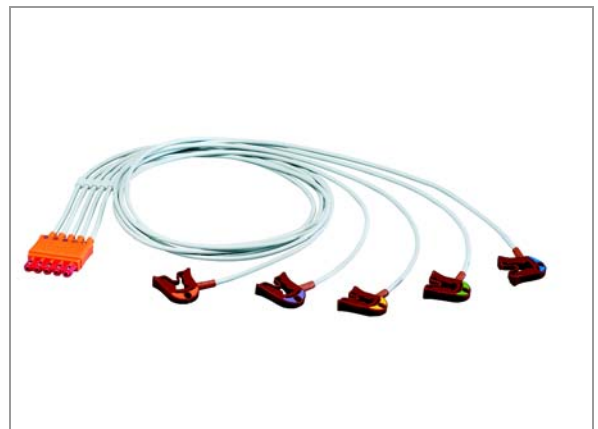

M1979A

5-Lead Sets for the M1663A Trunk Cable

Europe (IEC Color Coding)

Product Number	Description	Packaging Information		Use with Philips Trunk Cable
M1971A CEI	ICU grabber, limb	1 lead set	Pkg. wt. = 4oz (0.110kg)	Use M1663A 10-lead trunk cable.
M1978A CEI	ICU grabber, chest	1 lead set	Pkg. wt. = 4oz (0.110kg)	
M1645A CEI	ICU snap, limb	1 lead set	Pkg. wt. = 8oz (0.214kg)	
M1604A CEI	ICU snap, chest	1 lead set	Pkg. wt. = 9oz (0.250kg)	
M1974A CEI	OR grabber, limb	1 lead set	Pkg. wt. = 4oz (0.100kg)	
M1984A CEI	OR grabber, chest	1 lead set	Pkg. wt. = 4oz (0.100kg)	

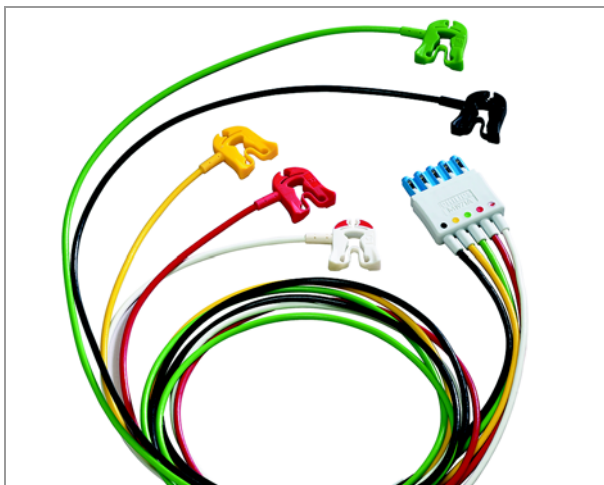

M1971A

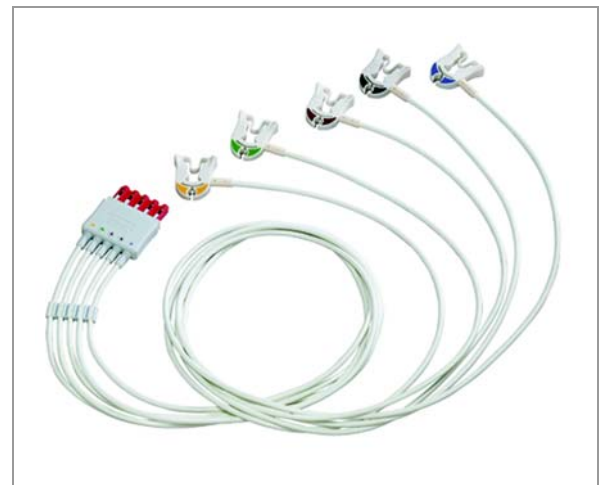

M1978A

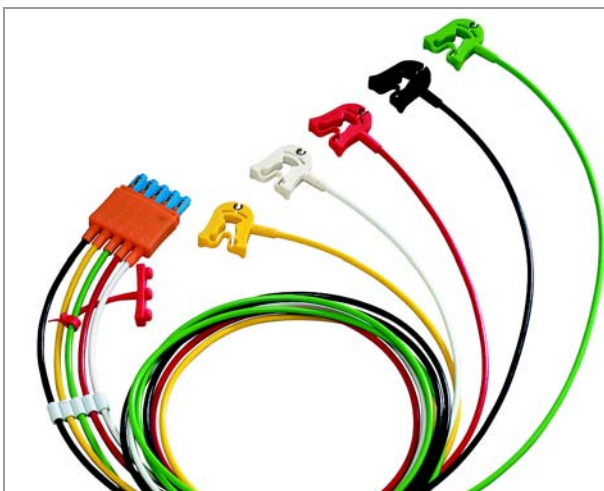

M1974A

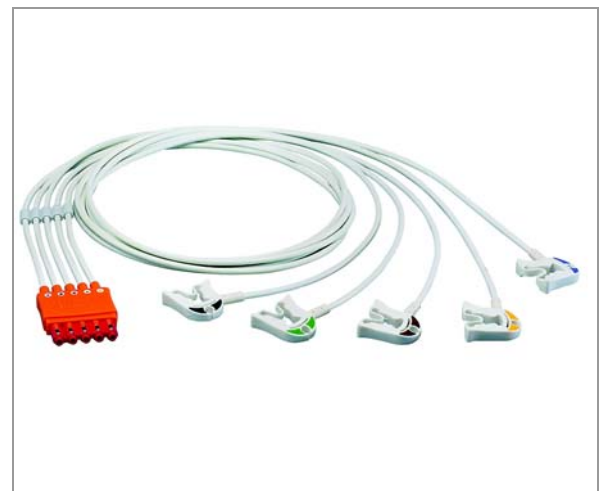

M1984A

10-Lead ECG Patient Cable Sets (6 + 4 Leads)

10-Lead Trunk Cable

- Leads to be ordered in pairs of: M1680A/M1532A; M1682A/M1537A; M1684A/M1557A; M1681A/M1533A; M1683A/M1538A; M1685A/M1558A for conventional diagnostic 12-lead ECG.

Product Number	Description	Packaging Information		Use with Philips Instrument
M1665A AAMI & IEC CE	10-lead ECG trunk cable with 12-pin ECG input connector. AAMI and IEC labels included. Length: 8.9' (2.7m)	1 pack= 1 cable	Pkg. wt. = 11oz (0.300kg)	M8102A Opt. C12 MP2 Monitor M8105A Opt. C12 MP5 Monitor M3001A Opt. C12 or Opt. C18 IntelliVue Multi- Measurement Modules M3002A Opt. C12 or Opt. C18 IntelliVue MMS X2

6-Lead plus 4-Lead Sets for the M1665A Trunk Cable

U.S. (AAMI Color Coding)

Product Number	Description	Packaging Information		Use with Philips Trunk Cable
M1680A	6-lead ICU grabber, limb	1 lead set	Pkg. wt. = 6oz (0.160kg)	Use M1665A 10-lead trunk cable.
M1532A	4-lead ICU grabber, chest	1 lead set	Pkg. wt. = 5oz (0.130kg)	
M1682A	6-lead ICU snap, limb	1 lead set	Pkg. wt. = 5oz (0.140kg)	
M1537A	4-lead ICU snap, chest	1 lead set	Pkg. wt. = 4oz (0.11kg)	
M1684A	6-lead OR grabber, limb	1 lead set	Pkg. wt. = 6oz (0.160kg)	
M1557A	4-lead OR grabber, chest	1 lead set	Pkg. wt. = 5oz (0.130kg)	

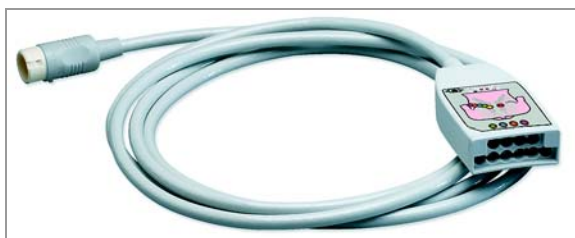

M1665A

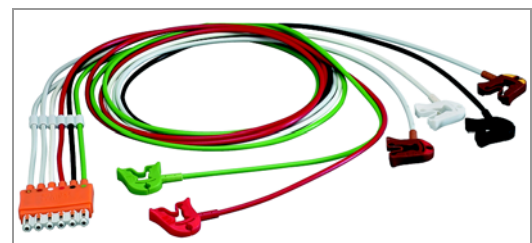

M1684A

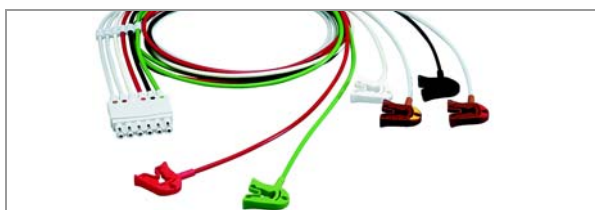

M1680A

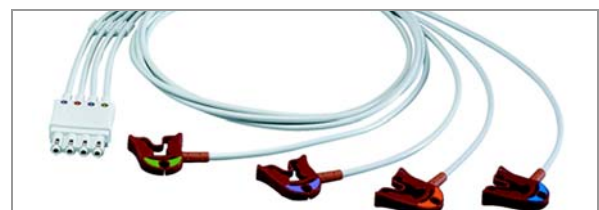

M1532A

6-Lead plus 4-Lead Sets for the M1665A Trunk Cable

Europe (IEC Color Coding)

Product Number	Description	Packaging Information		Use with Philips Trunk Cable
M1681A CEI	6-lead ICU grabber, limb	1 lead set	Pkg. wt. = 6oz (0.160kg)	Use M1665A 10-lead trunk cable.
M1533A CEI	4-lead ICU grabber, chest	1 lead set	Pkg. wt. = 5oz (0.130kg)	
M1683A CEI	6-lead ICU snap, limb	1 lead set	Pkg. wt. = 5oz (0.140kg)	
M1538A CEI	4-lead ICU snap, chest	1 lead set	Pkg. wt. = 4oz (0.110kg)	
M1685A CEI	6-lead OR grabber, limb	1 lead set	Pkg. wt. = 6oz (0.160kg)	
M1558A CEI	4-lead OR grabber, chest	1 lead set	Pkg. wt. = 5oz (0.130kg)	

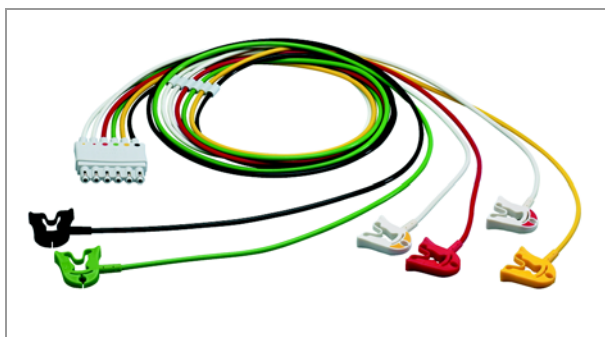

M1681A

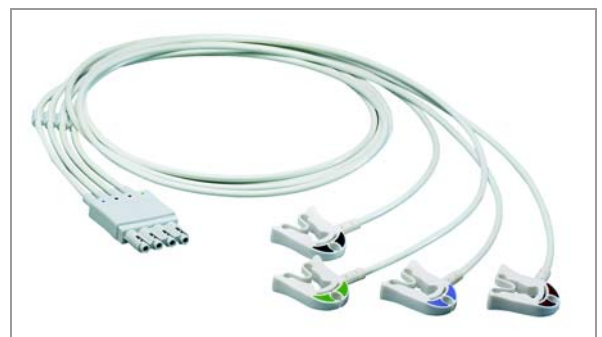

M1533A



M1685A



M1558A

6-Lead ECG Patient Cable Sets for 6-Lead Monitoring

6-Lead Trunk Cable

Product Number	Description	Packaging Information		Use with Philips Instrument
M1667A AAMI & IEC CE	6-lead ECG patient trunk cable with 12-pin ECG input connector. AAMI and IEC labels included. Length: 6.5' (2m)	1 pack= 1 cable	6oz (0.180kg)	M8102A Opt. C12 MP2 Monitor M8105A Opt. C12 MP5 Monitor M3001A Opt. C12 or Opt. C18 IntelliVue Multi-Measurement Module M3002A Opt. C12 or C18 IntelliVue MMS X2

6-Lead Sets for the M1667A Trunk Cable

U.S. (AAMI Color Coding)

Product Number	Description	Packaging Information		Use with Philips Trunk Cable
M1680A	6-lead ICU grabber, limb	1 lead set	6oz (0.160kg)	Use M1667A 6-lead trunk cable.
M1682A	6-lead ICU snap, limb	1 lead set	5oz (0.140kg)	
M1684A	6-lead OR grabber, limb	1 lead set	6oz (0.160kg)	



M1667A



M1680A

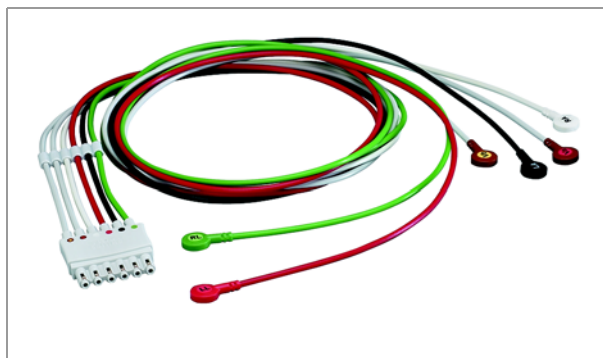

M1682A

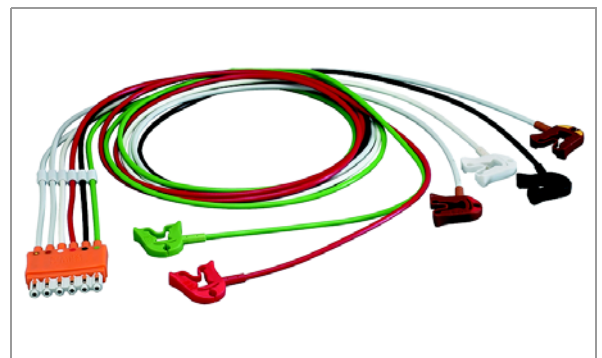

M1684A

6-Lead Sets for the M1667A Trunk Cable

Europe (IEC Color Coding)

Product Number	Description	Packaging Information		Use with Philips Trunk Cable
M1681A CEI	6-lead ICU grabber, limb	1 lead set	6oz (0.160kg)	Use M1667A 6-lead trunk cable.
M1683A CEI	6-lead ICU snap, limb	1 lead set	5oz (0.140kg)	
M1685A CEI	6-lead OR grabber, limb	1 lead set	6oz (0.160kg)	



M1667A

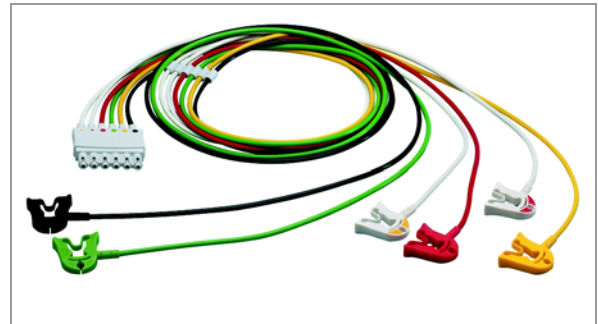

M1681A

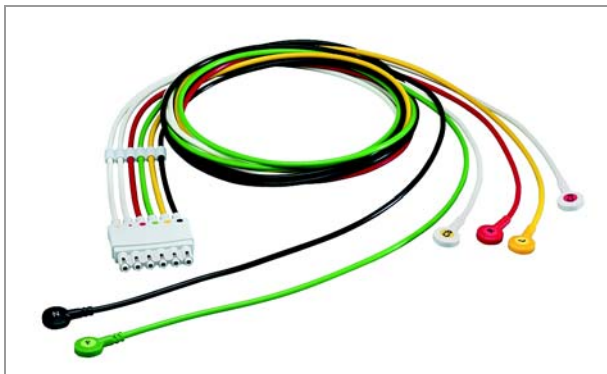

M1683A



M1685A

5-Lead ECG Patient Cable Sets for Standard 5-Lead Monitoring

5-Lead Patient Trunk Cable

(AAMI & IEC)

Product Number	Description	Packaging Information		Use with Philips Instrument
M1668A AAMI & IEC CE	<p>5-lead ECG patient trunk cable with 12-pin ECG input connector. AAMI and IEC labels included. Length: 9' (2.7m)</p> 	1 pack = 1 cable	Pkg. wt. = 7oz (0.200kg)	<p>78352C, 78354C, 78834C Legacy HP Patient Monitors</p> <p>862472 to 862475 C3 Monitor 862478, 862479 C3 Monitor</p> <p>863064, 863065, 863066, 863068 SureSigns VM6, VM8</p> <p>ECG Modules M1001A/B, M1002A/B</p> <p>Multi-Measurement Modules M3000A, M3001A</p> <p>M3002A MMS X2</p> <p>M8102A MP2 Monitor</p> <p>M8105A MP5 Monitor</p> <p>M4735A HeartStart XL Defibrillator/ Monitor</p> <p>M3535A/M3536A HeartStart MRx Defibrillator/ Monitor</p>

5-Lead Sets (photos next page)

U.S. (AAMI Color Coding)

Product Number	Description	Packaging Information		Use with Philips Trunk Cable
M1968A	ICU grabber, limb	1 lead set	Pkg. wt. = 4oz (0.110kg)	Use M1668A 5-lead trunk cable.
M1644A	ICU snap, limb	1 lead set	Pkg. wt. = 8oz (0.214kg)	
M1973A	OR grabber, limb	1 lead set	Pkg. wt. = 4oz (0.100kg)	
M1647A	Miniclip grabber, unshielded	1 lead set	Pkg. wt. = 5oz (0.150kg)	

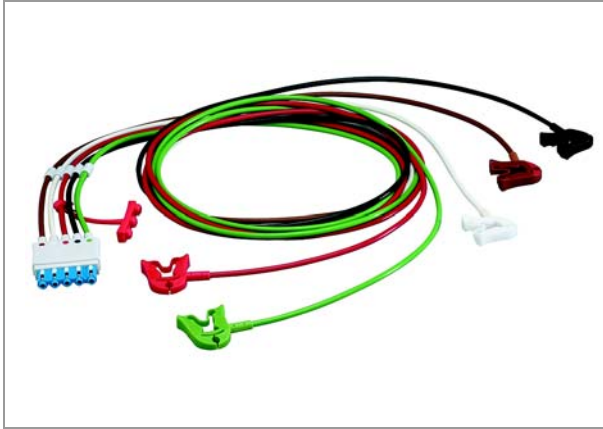

M1968A

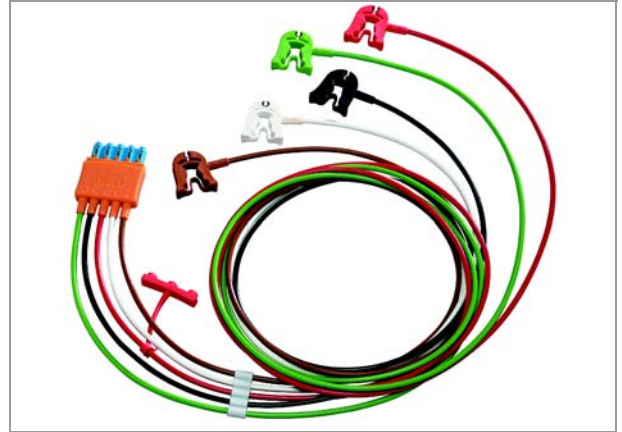

M1973A

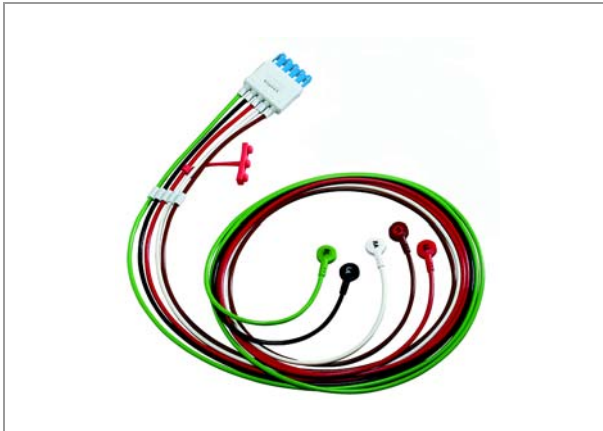

M1644A



M1647A

5-Lead Sets

Europe (IEC Color Coding)

Product Number	Description	Packaging Information		Use with Philips Trunk Cable
M1971A CEI	ICU grabber, limb	1 lead set	Pkg. wt. = 4oz (0.110kg)	Use M1668A 5-lead trunk cable
M1645A CEI	ICU snap, limb	1 lead set	Pkg. wt. = 8oz (0.214kg)	
M1974A CEI	OR grabber, limb	1 lead set	Pkg. wt. = 4oz (0.100kg)	
M1648A CEI	Miniclip grabber, unshielded	1 lead set	Pkg. wt. = 5oz (0.150kg)	

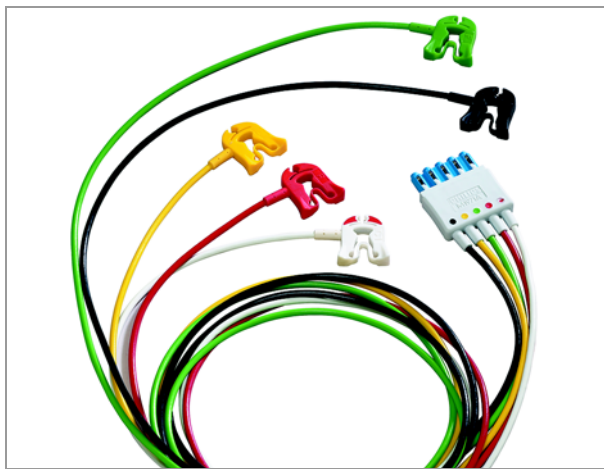

M1971A

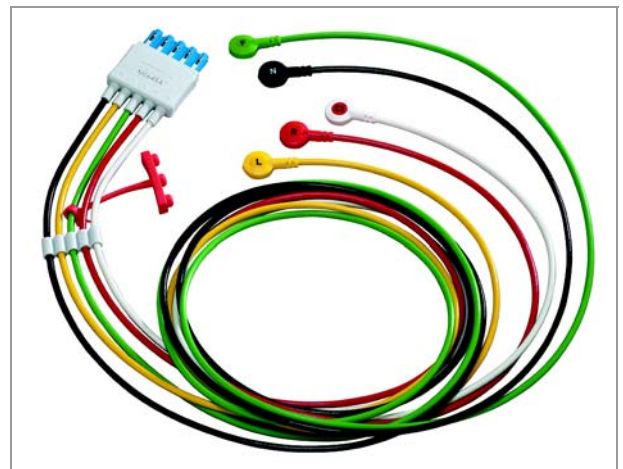

M1645A

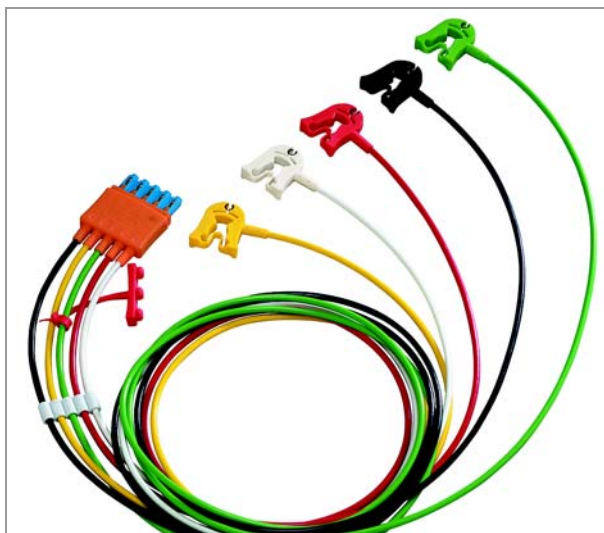

M1974A

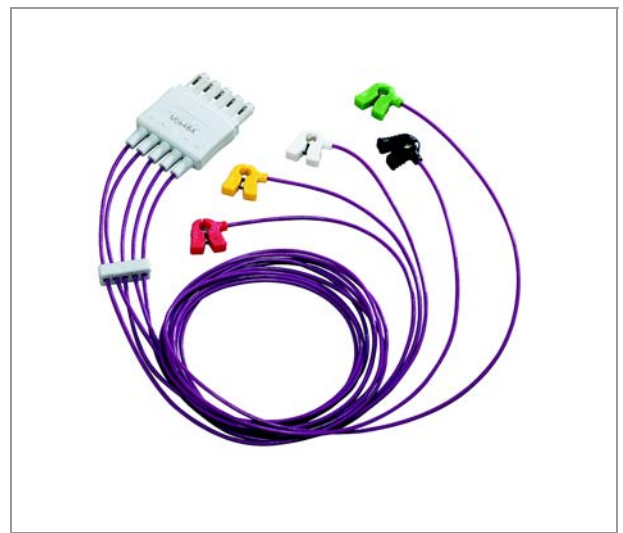

M1648A

3-Lead ECG Patient Cable Sets for Standard 3-Lead Monitoring

3-Lead Patient Trunk Cable

(AAMI & IEC)

Product Number	Description	Packaging Information		Use with Philips Instrument
M1669A AAMI & IEC CE	<p>3-lead ECG patient trunk cable with 12-pin ECG input connector. AAMI and IEC labels included. Length: 9' (2.7m)</p> 	1 pack = 1 cable	Pkg. wt. = 8oz (0.233kg)	<p>78352C, 78354C, 78834C Legacy HP Monitors</p> <p>862472 to 862475 (C3) 862478, 862479 (C3)</p> <p>863063, 863064, 863065, 863066, 863068, 863077 VM3, VM4, VM6, VM8</p> <p>M1001A/B, M1002A/B ECG Modules</p> <p>M3000A, M3001A Multi-Measurement Modules M3002A IntelliVue MMS X2</p> <p>M8102A MP2 Monitor M8105A MP5 Monitor</p> <p>M4735A HeartStart XL Defibrillator/Monitor</p> <p>M3535A/M3536A HeartStart MRx Defibrillator/Monitor</p>

3-Lead Sets (photos next page)

U.S. (AAMI Color Coding)

Product Number	Description	Packaging Information		Use with Philips Trunk Cable
M1671A	ICU grabber	1 lead set	Pkg. wt. = 4oz (0.100kg)	Use M1669A 3-lead trunk cable
M1673A	ICU snap	1 lead set	Pkg. wt. = 6oz (0.181kg)	
M1675A	OR grabber	1 lead set	Pkg. wt. = 8oz (0.230kg)	
M1622A	Miniclip grabber, unshielded	1 lead set	Pkg. wt. = 5oz (0.150kg)	
M1624A	Miniclip grabber, unshielded	1 lead set	Pkg. wt. = 5oz (0.149kg)	



M1671A



M1673A



M1675A



M1624A

3-Lead Sets

Europe (IEC Color Coding)

Product Number	Description	Packaging Information		Use with Philips Trunk Cable
M1672A CEI	ICU grabber	1 lead set	Pkg. wt. = 4oz (0.100kg)	Use M1669A 3-lead trunk cable
M1674A CEI	ICU snap	1 lead set	Pkg. wt. = 6oz (0.181kg)	
M1678A CEI	OR grabber	1 lead set	Pkg. wt. = 8oz (0.230kg)	
M1626A CEI	Miniclip grabber, unshielded	1 lead set	Pkg. wt. = 5oz (0.150kg)	

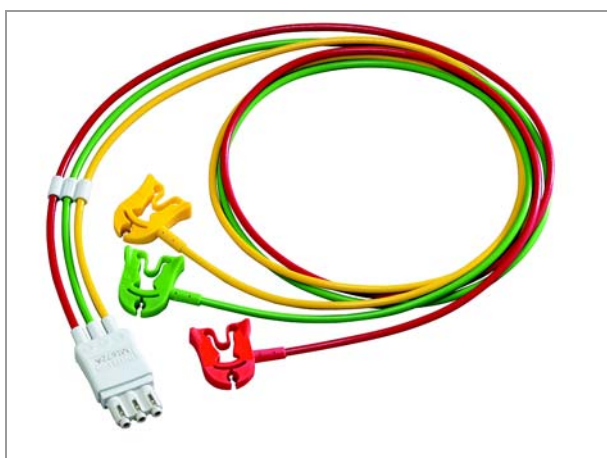

M1672A

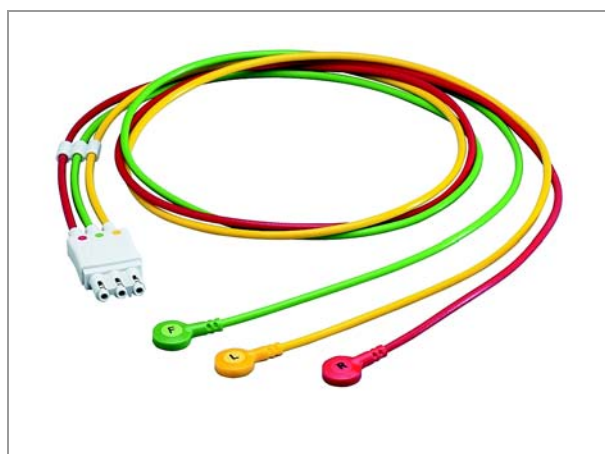

M1674A

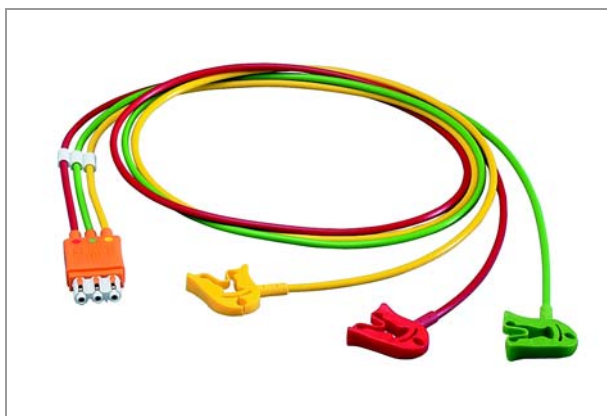

M1678A

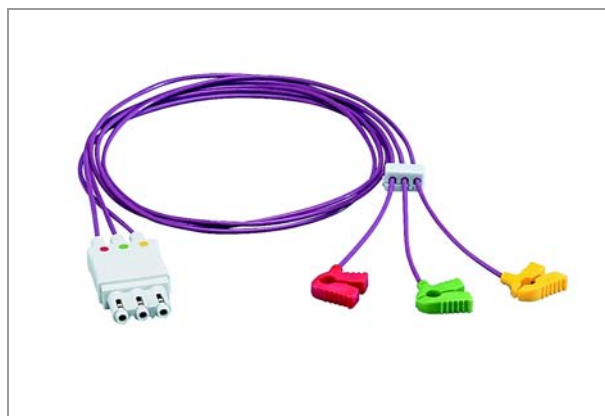

M1626A

ECG Cable Accessories

Lead Set Organizers and Patient Cable Organizers

Product Number	Description	Packaging	Use with Philips Lead Set
M1503A Photo next page	3-Electrode set organizer, shielded (10 organizers)	Pkg. wt. = 4oz (.12kg)	All shielded lead sets (AAMI/IEC)
M1664A	4-Electrode set organizer, shielded (10 organizers)		(AAMI) M1532A, M1537A, M1557A (IEC) M1533A, M1538A, M1558A
M1504A	5-Electrode set organizer, shielded (10 organizers)		All shielded lead sets (AAMI/IEC)
M1679A	6-Electrode set organizer, shielded (10 organizers)		(AAMI) M1680A, M1682A, M1684A, M1532A, M1537A, M1557A (IEC) M1681A, M1683A, M1685A, M1558A, M1533A, M1538A
M1636A	3-Electrode set organizer, unshielded (10 organizers)		All unshielded lead sets (AAMI/IEC)
M1638A	5-Electrode set organizer, unshielded (10 organizers)		All unshielded lead sets (AAMI/IEC)
M1509A	Repositionable bedsheet clip fits on any trunk cable. Clip can be adjusted along the cable length. (3 clips/pack)		Any cables
M2281A Photo next page	Patient cable organizer (hooks). Helps keep patient cables off the floor and organized. (8 hooks/pack)	Pkg. wt. = 2.5oz (0.07kg)	Any cables
9898031 48841 photo next page	IntelliVue Cable Management Kit: Helps keep patient cables organized. (5 organizers/pack)	Pkg. wt. = 2oz (.060kg)	Any cables
9898031 48861 photo next page	Trunk Cable Covers (10 covers/pack)	Pkg. wt. = 0.35oz (.010kg)	For M1663A or M1949A 10-Lead Trunk Cables (To protect unused sockets when monitoring 5-lead.)

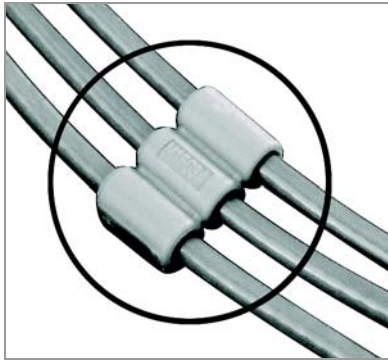

M1503A

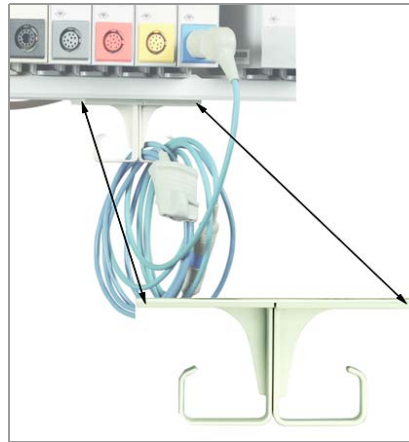

M2281A

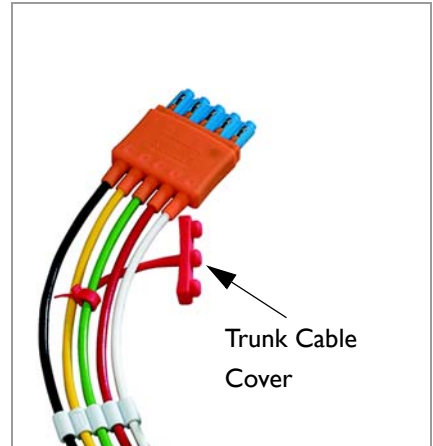

9898031 48861

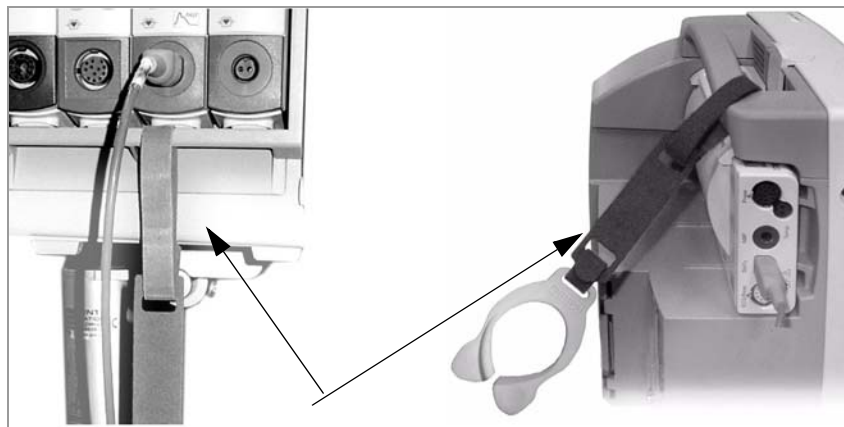

9898031 48841 IntelliVue Cable Management Kit

Radiolucent ECG Lead Sets

Radiolucent ECG Lead Sets

Product Number	Description	Packaging Information		Use with Philips Trunk Cable
M1649A CEI	Unshielded black 5-lead set with safety connectors. Grabber termination, radiolucent, 5 individual wires. AAMI or IEC color coding. Length=36" (914mm).	1 pack = 5-lead set	Pkg. wt. = 1oz (28g)	Any Philips ECG trunk cable except M1949A and M3525A

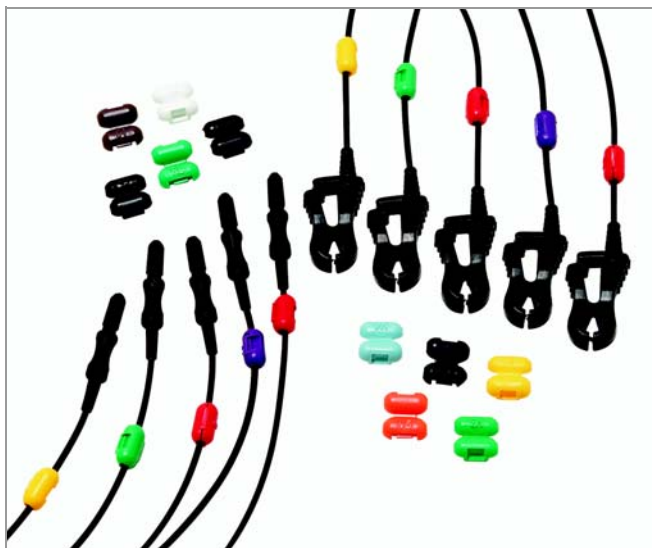

M1649A

SureSigns VM4, VM6, VM8 ECG Cables and Leads

VM4/VM6/VM8 ECG Cables and Leads

Product Number	Description	Packaging Information			Use with Philips Instrument
9898031 43171 IEC CEI	One piece 3-lead cable, grabber connectors	Length: 8.3 ft (2.5m)	1 cable	Pkg. wt. = 5.6oz.(160g)	863063 (VM4)
9898031 43181 AAMI	One piece 3-lead cable, grabber connectors				863064 (VM6)
9898031 43191 IEC CEI	One piece 5-lead cable, grabber connectors			Pkg. wt. = 6.4oz.(180g)	863065 (VM6)
9898031 43201 AAMI	One piece 5-lead cable, grabber connectors				863066 (VM8)
					863068 (VM8)
					M8102A (MP2)
					M8105A (MP5)



9898031 43171



9898031 43181



9898031 43191



9898031 43201

A1/A3/C1 ECG Cables and Leads

A1/A3/C1 ECG Cables and Leads

Product Number	Description	Packaging Information	Use with Philips Instrument
M3913A AAMI/IEC CE	ECG trunk cable, 3-lead, used with M3914A and M3915A lead sets. Color-coded to be used with AAMI and IEC lead sets. Length=10' (3m) U.S. & Europe	Pkg. wt. = 0.3 lbs (13.61g)	M3923A M3924A M3926A M3927A M3928A M3929A 863053 863054
M3914A IEC CE	Snap ECG safety lead set, 3-lead, for use with trunk cable M3913A (red, yellow, and green wires). Europe	Pkg. wt. = 1.3oz (37g)	
M3915A AAMI CE	Snap ECG safety lead set, 3-lead, for use with trunk cable M3913A (red, black, and white wires). U.S.		

ICG Cable for Non-Invasive Hemodynamic Monitoring

Philips ICG (Impedance Cardiography) Cable

Product Number	Description	Packaging Information	Use with Philips Instrument
M4620A CE	One piece cable, grabber connectors Length= 7'11" to 9'2" (2-3m)	1 bag= 1 cable Pkg. wt. = 0.53 lb (0.24g)	862146 ICG Non-Invasive Hemodynamic Monitor

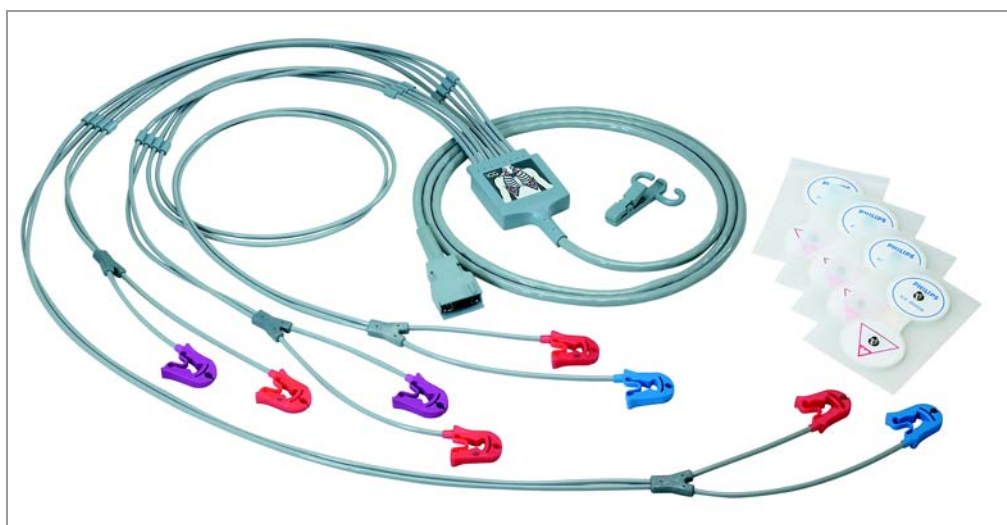

M4620A Cable with M4608A Sensors

Telemetry

IntelliVue Telemetry System (TRx4851A/TRx4841A/M2601B) Lead Sets

U.S. (AAMI Color Coding)

Product Number	Description	Packaging Information		Use with Philips Instrument
9898031 51991 CEI	3-lead set, gray wire, snap connectors and shower shield.	1 lead set Length: 34" (85cm)	Pkg. wt. = 3.5oz (0.100kg)	862231 TRx4851A Transceiver (non U.S.)
9898031 51971 CEI	3-lead set, gray wire, grabber connectors and shower shield.			862439 TRx4841A Transceiver (U.S. only)
9898031 52071 CEI	5-lead set, multi-color wire, snap connectors and shower shield.			862108 M2601B Transmitter
9898031 52051 CEI	5-lead set, multi-color wire, grabber connectors and shower shield.		Pkg. wt. = 7.05oz (0.200kg)	862231 TRx4851A Transceiver (non U.S.)
9898031 52151 CEI	6-lead set, multi-color wire, snap connectors and shower shield.			862439 TRx4841A Transceiver (U.S. only)
9898031 52131 CEI	6-lead set, multi-color wire, grabber connectors and shower shield.			



9898031 51971



9898031 52051



9898031 52131

IntelliVue Telemetry System (TRx4851A/M2601B) Lead Sets

Europe (IEC Color Coding)

Product Number	Description	Packaging Information		Use with Philips Instrument
9898031 52001 CEI	3-lead set, gray wire, snap connectors and shower shield.	1 lead set Length: 34” (85cm)	Pkg. wt. = 3.5oz (0.100kg)	862231 TRx4851A Transceiver 862108 M2601B Transmitter
9898031 51981 CEI	3-lead set, gray wire, grabber connectors and shower shield.			
9898031 52081 CEI	5-lead set, multi-color wire, snap connectors and shower shield.			
9898031 52061 CEI	5-lead set, multi-color wire, grabber connectors and shower shield.		Pkg. wt. = 7.05oz (0.200kg)	862231 TRx4851A Transceiver
9898031 52161 CEI	6-lead set, multi-color wire, snap connectors and shower shield.			
9898031 52141 CEI	6-lead set, multi-color wire, grabber connectors and shower shield.			



9898031 52081



9898031 52061

IntelliVue System Trunk Cables and Telemetry Tether Cables

Product Number	Description	Packaging Information		Use with Philips Instrument
M1669A CEI	3-Lead trunk cable for connection to 3-lead telemetry leadset to IntelliVue patient monitor.	1 cable	Pkg. wt. = 7oz (0.200kg)	TRx4841A and TRx4851A Transceiver, M2601B Transmitter
M1668A CEI	5-Lead trunk cable for connection to 5-lead telemetry leadset to IntelliVue patient monitor.	1 cable	Pkg. wt. = 8oz (0.233kg)	
M1667A CEI	6-Lead trunk cable for connection to 6-lead telemetry leadset to IntelliVue patient monitor.	1 cable	Pkg. wt. = 8oz (0.233kg)	
M1663A CEI	10-Lead (5+5) trunk cable for connection to 5-lead telemetry leadset to IntelliVue patient monitor.	1 cable	Pkg. wt. = 11oz (0.300kg)	
M1665A CEI	10-Lead (6+4) trunk cable for connection to 6-lead telemetry leadset to IntelliVue patient monitor.	1 cable	Pkg. wt. = 11oz (0.300kg)	
9898031 43481 CEI	PWD Tether cable connects to the TRx4841A/TRx4851A Transceiver or M2601B Transmitter to the TeleMon Tether Cable (9898031 43491) or the MP5 Tether Cable (9898031 46911). Length: 20" (51cm)	1 cable	Pkg. wt. = 4.09oz (116g)	
9898031 43491 CEI	TeleMon Tether cable connects the M2636C TeleMon to the PWD Tether cable (9898031 43481). Length: 78.7" (2m)	1 cable	Pkg. wt. = 1.2 lb (520g)	
9898031 46911 CEI	MP5 Tether cable connects the MP5 to the PWD Tether cable (9898031 43481). Length: 78.7" (2m)	1 cable		



M1663A

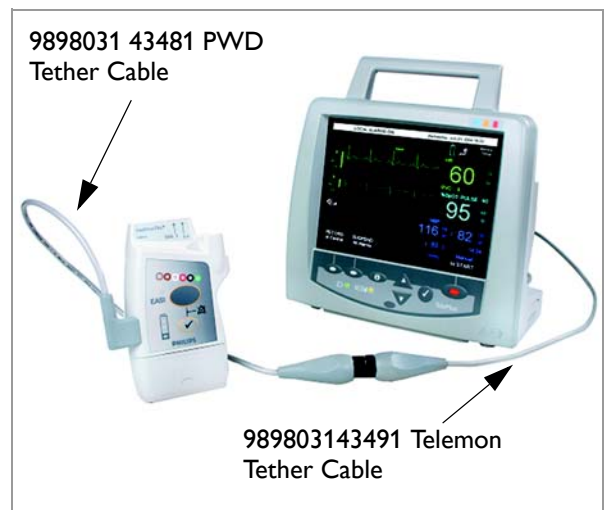

Tether cables shown with IntelliVue TRx and TeleMon

Replacement Shower Shields and Alignment Guides

Product Number	Description	Packaging Information	Used with:
9898031 53031	3-Lead Shower Shields (bag of 10)	Pkg. wt. = 4oz (.12kg)	IntelliVue Telemetry System Lead Sets for TRx4841A, TRx4851A, M2601B
9898031 53041	5-Lead Shower Shields (bag of 10)		
9898031 53051	6-Lead Shower Shields (bag of 10)		
9898031 40401	Single ECG alignment guide/protective insert, untethered (bag of 10).	Pkg. wt. = 0.35oz (.010kg)	862231 (TRx4851A) Transceiver
9898031 40411	Single ECG alignment guide/protective insert, tethered (bag of 10).		862439 (TRx4841A) Transceiver
9898031 40421	Double ECG alignment guide/protective insert, untethered (bag of 10).		862108 (M2601B) Transmitter IntelliVue Telemetry



989803153041 Shower Shield shown attached to 5-lead connector.



Alignment Guides for IntelliVue Telemetry System

Telemetry Lead Sets

U.S. (AAMI Color Coding)

Product Number	Description	Packaging Information			Use with Philips Instrument	
M1420A	3-lead set, snap termination	Use with M1403A digital UHF telemetry. Leads are not individually replaceable.	Length = 30" (76cm)	1 pack = 1 lead set	M1403A transmitter	
M1421A	3-lead set, grabber termination					
M1422A	4-lead set, snap termination					
M1423A	4-lead set, grabber termination					
M1424A	5-lead set, snap termination					
M1425A	5-lead set, grabber termination					
M2590A CEI	3-lead set, snap termination	Use with M2601A transmitter for the M2600A Philips Telemetry system.	Length = 30" (76cm)	1 pack = 1 lead set	M2600A, M2601A transmitters	
M2591A CEI	3-lead set, grabber termination.				M2636A	
M2592A CEI	5-lead set, snap termination.					
M2593A CEI	5-lead set, grabber termination.					
M2598A	3-lead combiner shield (available only in the U.S.)			1 pack = 1 shield	Pkg. wt. = 1oz (28g)	M2601A (Viridia Transmitter)
M2599A	5-lead combiner shield (available only in the U.S.)					M2636A (TeleMon)

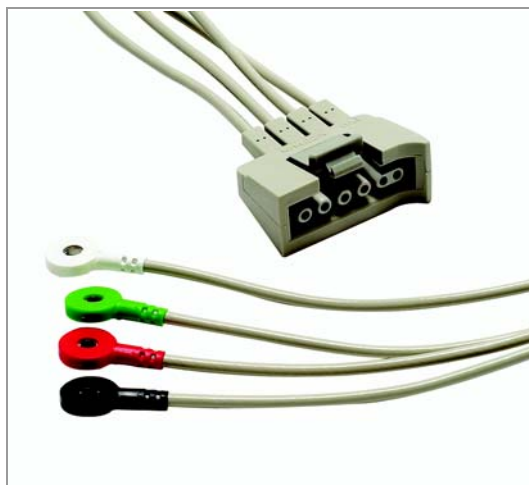

M1422A



M2593A

Telemetry Lead Sets

Europe (IEC Color Coding)

Product Number	Description			Packaging Information		Use with Philips Instrument
M1430A	3-lead set, snap termination.	Use with M1403A digital UHF telemetry. Leads are not individually replaceable.	Length = 30" (76cm)	1 pack = 1 lead set	Pkg. wt. = 2oz (57g)	M1403A transmitter
M1431A	3-lead set, grabber termination.					
M1432A	4-lead set, snap termination.					
M1433A	4-lead set, grabber termination.					
M1434A	5-lead set, snap termination.					
M1435A	5-lead set, grabber termination.					
M2594A CEI	3-lead set, snap termination.	Use with M2601A transmitter for the M2600A Philips Telemetry system.	Length = 30" (76cm)	1 pack = 1 lead set	Pkg. wt. = 2oz (57g)	M2600A M2601A transmitters M2636A
M2595A CEI	3-lead set, grabber termination.				Pkg. wt. = 2.5oz (71g)	
M2596A CEI	5-lead set, snap termination.				Pkg. wt. = 3oz (84g)	
M2597A CEI	5-lead set, grabber termination.				Pkg. wt. = 3.5oz (101g)	



M2595A



M2597A

ECG Extender Cables for TeleMon

Product Number	Description	Packaging Information		Use with Philips Instrument
M4793A AAMI	5-lead ECG trunk cable. Adds length to standard telemetry ECG 5-lead cables (AAMI colors). Recommended when TeleMon is to be used at patient's bedside.	1 pack = 1 cable	Pkg. wt. = 1 lb (454g)	M2636A, M2636B, M2636C
M4794A IEC CE	5-lead ECG trunk cable. Adds length to standard telemetry ECG 5-lead cables (IEC colors). Recommended when TeleMon is to be used at patient's bedside.			
M4795A AAMI	3-lead ECG trunk cable. Adds length to standard telemetry ECG 5-lead cables (AAMI colors). Recommended when TeleMon is to be used at patient's bedside.	Pkg. wt. = 0.40lbs (181kg)		
M4796A IEC CE	3-lead ECG trunk cable. Adds length to standard telemetry ECG 5-lead cables (IEC colors). Recommended when TeleMon is to be used at patient's bedside.			



M4794A

Defibrillator ECG Patient Cables and Leads

ECG Defibrillator Cables

U.S. (AAMI Color Coding)

Product Number	Description	Packaging Information		Use with Philips Instrument
M1733A	One-piece patient trunk cable. Defibrillator protection, shielded, snap termination. Individual leads are not replaceable.	3-lead, 8-pin connector, 10.5' (3.2m) long	1 pack = 1 cable	M1722A/B (CodeMaster XL+, XL) M2475B (CodeMaster 100)
M1734A		5-lead, 8-pin connector, 10.5' (3.2m) long		M3500B (Heartstream/HeartStart XLT) M5500B (Heartstart 4000)

ECG Defibrillator Cables

Europe (IEC Color Coding)

Product Number	Description	Packaging Information		Use with Philips Instrument
M1735A CEI	One-piece patient trunk cable. Defibrillator protection, shielded, snap termination. Individual leads are not replaceable.	3-leads, 8-pin connector, 10.5' (3.2m) long	1 pack = 1 cable	M1722A/B (CodeMaster XL+, XL) M2475B (CodeMaster 100)
M1736A CEI		5-leads, 8-pin connector, 10.5' (3.2m) long		M3500B (Heartstream/HeartStart XLT) M5500B (Heartstart 4000)

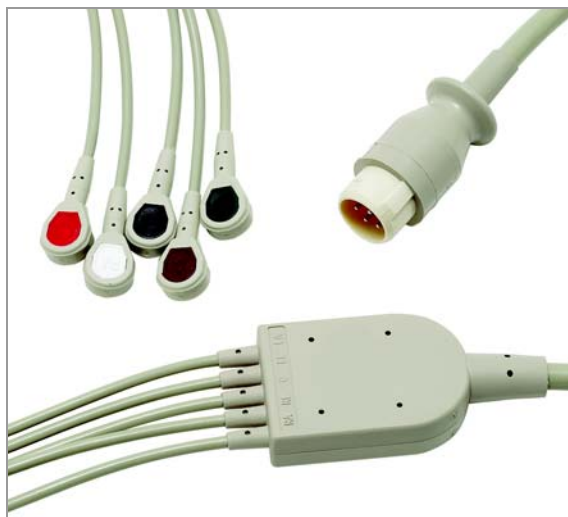

M1734A



M1735A

HeartStart MRx Monitor/Defibrillator ECG Cable Set

- Use with M3525A or 9898031 47691 Patient Trunk Cable
- Lead sets (excluding mini clips) listed on page 3-10, 3-12, 3-17, 3-19, 3-20 and 3-22 are also compatible with the M3525A and 9898031 47691 Patient Trunk Cables.

10-Lead Cable Sets (3 and 7 electrode combination)

U.S. (AAMI Color Coding)

Product Number	Description	Packaging Information		Use with:
M3526A CEI	3-electrode lead set and plug, snap termination	12-pin connector	1 pack = 1 cable	Pkg. wt. = 4oz (114g)
M3527A CEI	7-electrode lead set for 12-lead monitoring, snap termination. Use with the M3526A lead set and M3525A 9898031 47691 trunk cable.			Pkg. wt. = 6oz (171g)

10-Lead Cable Sets (3 and 7 electrode combination)

Europe (IEC Color Coding)

Product Number	Description	Packaging Information		Use with:
M3528A CEI	3-electrode lead set and plug, snap termination	12-pin connector	1 pack = 1 cable	Pkg. wt. = 4oz (114g)
M3529A CEI	7-electrode lead set for 12-lead monitoring, snap termination. Use with the M3528A lead set and M3525A or 9898031 47691 trunk cable.			Pkg. wt. = 6oz (171g)

10-Lead ECG Patient Trunk Cable

Product Number	Description	Packaging Information		Use with Philips Instrument
M3525A CEI	10-lead ECG Trunk Cable for 3 and 7 electrode combination sets. Length: 2m	12-pin connector	1 pack = 1 cable	Pkg. wt. = 11.2oz (0.318kg)
9898031 47691 CEI	10-lead ECG Trunk Cable for 3 and 7 electrode combination sets. Length: 1.3m			Pkg. wt. = 6.5oz (0.186kg)



M3525A

Diagnostic ECG Trunk Cables

Cardiology Patient Cables

U.S. (AAMI Color Coded)

Product Number	Description	Packaging Information		Use with Philips Instrument
M3702A	Color-coded, shielded trunk cable with 1/8" posts and 10 leads.	1 pack = 1 cable	Pkg. wt. = 15.7oz (440g)	M1770A M1771A M1772A M2662A
M3702C	Color-coded, shielded combination trunk cable and lead set with 1/8" posts and 10 leads.		Pkg. wt. = 12.8oz (358g)	M1770A M1771A M1772A

Cardiology Patient Cables

Europe (IEC Color Coded)

Product Number	Description	Packaging Information		Use with Philips Instrument
M3703A CEI	Color-coded, shielded trunk cable with 4mm posts and 10 leads.	1 pack = 1 cable	Pkg. wt. = 15.7oz (440g)	M1770A M1771A M1772A M2662A
M3703C CEI	Color-coded, shielded combination trunk cable and lead set with 4mm posts and 10 leads.		Pkg wt= 12.8oz (358g)	M1770A M1771A M1772A

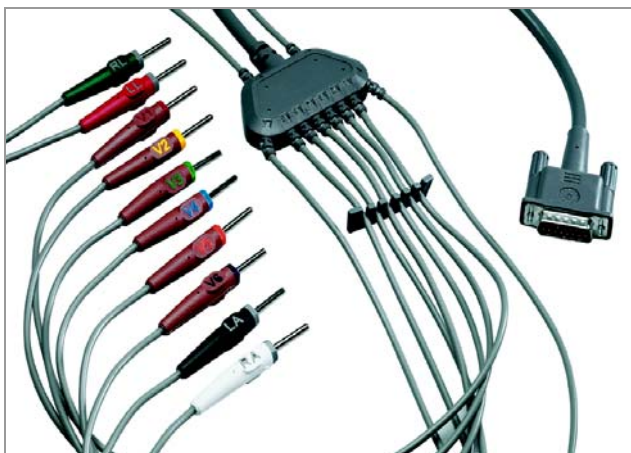

M3702A



M3703A

Patient Data Cables

Product Number	Description	Packaging Information		Use with Philips Instrument
M1719A	Patient data cable for Philips PageWriter XL. Length: 8' (2.5m)	1 pack = 1 cable	Pkg. wt. = 5oz (142g)	M1700A M1701A M1702A
M1720A	Patient data cable for Philips PageWriter XL. Length: 30' (9m)		Pkg. wt. = 15oz (425g)	
9898031 45401	USB patient data cable for Philips PageWriter Touch. Length: 6.89' (2.1m)		Pkg. wt. = 3.1oz (90g)	860284 860285

Diagnostic ECG Lead Sets

PageWriter XL Complete Lead Sets - Shielded

U.S. (AAMI Color Coding)

Product Number	Description	Packaging Information		Use with Philips Instrument
M1713B See photo	Complete lead set, consisting of 4 limb leads (39"/99 cm), 6 chest leads (24"/61 cm), 10 color marked rings, 4 shorting plugs, and 2 lead separators.	1 pack = 1 lead set	Pkg. wt. = 7oz (198g)	M1700A M1701A M1702A

PageWriter XL Complete Lead Sets - Shielded

Europe (IEC Color Coding)

Product Number	Description	Packaging		Use with Philips Instrument
M1716B CE	Complete lead set, consisting of 4 limb leads (39"/99 cm), 6 chest leads (24"/61 cm), 10 color marked rings, 4 shorting plugs, and 2 lead separators.	1 pack = 1 lead set	Pkg. wt. = 7oz (198g)	M1700A M1701A M1702A

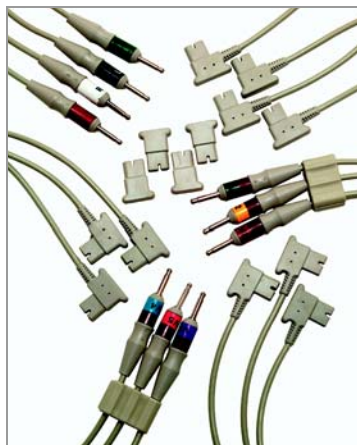

M1713B



M1716B

StressVue Patient Cables and Leads

U.S. (AAMI Color Coding)

Product No.	Description	Packaging Information		Use with Philips Instrument
9898031 36951	Standard Patient 10-lead set, AAMI	1 bag = 1 lead set	Pkg. wt. = 3.5oz (0.100kg)	StressVue 860295
9898031 37661	Large Patient 10-lead set, AAMI			

StressVue Patient Cables and Leads

Europe (IEC Color Coding)

Product No.	Description	Packaging Information		Use with Philips Instrument
9898031 36961	Standard Patient 10-lead set, IEC	1 bag = 1 lead set	Pkg. wt. = 3.5oz (0.100kg)	StressVue 860295
9898031 37671	Large Patient 10-lead set, IEC			

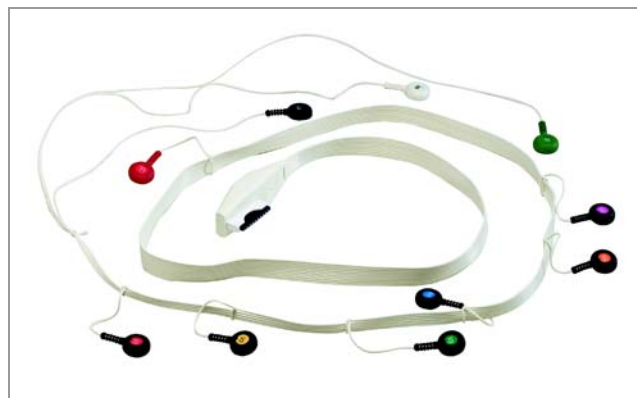

9898031 37661

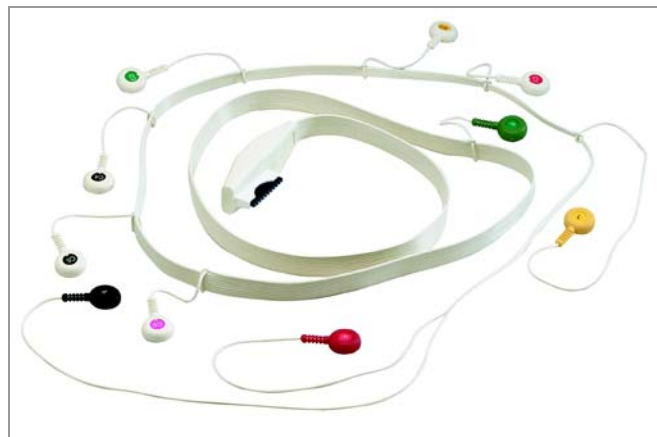

9898031 37671

Diagnostic ECG Replacement Leads

Cardiology Shielded Replacement Leads-
PageWriter Touch, PageWriter Trim

U.S. (AAMI Color Coding)

Product No.	Description	Packaging Information			Use with Philips Instrument
9898031 29141 CEI	Limb lead set for PageWriter Touch/Trim, consisting of 2 limb leads, 8 color marked rings, 8 colored base rings, and instruction sheet.	Length= 39" (99cm)	1 pack = 1 set	Pkg. wt. = 2oz (57g)	860284 (PageWriter Touch)
9898031 29151	Chest lead set for PageWriter Touch/Trim, consisting of 3 chest leads, 12 color marked rings, 3 brown rings, and instruction sheet.	Length= 24" (61cm)	1 pack = 1 set	Pkg. wt. = 2oz (57g)	860286 860287
9898031 29161	Complete lead set for PageWriter Touch/Trim, consisting of 4 limb leads, 6 chest leads, 10 color marked rings, and 2 lead separators.	Length= 39" (99cm) 24" (61cm)	1 pack = 1 set	Pkg. wt. = 7oz (198g)	860288 860290 (PageWriter Trim)
9898031 48931	Upgrade Kit 12-15/16 leads, for PageWriter Touch consisting of 4 chest leads, 4 shorting plugs, 2 lead separators, 4 colored clip rings and 5 color marked rings, brown base rings and 2 assembly instructions.	Length= 33" (84cm)	1 pack = 1 kit	Pkg. wt. = (.070 kg)	860284 PageWriter Touch

Cardiology Shielded Replacement Leads-
PageWriter Touch, PageWriter Trim

Europe (IEC Color Coding)

Product No.	Description	Packaging Information			Use with Philips Instrument
9898031 29171 CEI	Limb lead set for PageWriter Touch/Trim, consisting of 2 limb leads, 8 color marked rings, 8 colored base rings, 2 banana plugs and instruction sheet.	Length= 39" (99cm)	1 pack= 1 set	Pkg. wt. = 2oz (57g)	860284 (PageWriter Touch)
9898031 29181 CEI	Chest lead set for PageWriter Touch/Trim, consisting of 3 chest leads, 12 color marked rings, 3 brown rings, 3 banana adapters, 1 lead separator, and instruction sheet.	Length= 24" (61cm)	1 pack= 1 set	Pkg. wt. = 2oz (57g)	860286 860287 860288
9898031 29191 CEI (see photo on next page)	Complete lead set for PageWriter Touch/Trim, consisting of 4 limb leads, 6 chest leads, 10 color marked rings; and 2 lead separators.	Length= 39" (99cm) 24" (61cm)	1 pack= 1 set	Pkg. wt. = 7oz (198g)	860290 (PageWriter Trim)
9898031 49181 CEI	Upgrade Kit 12-15/16 leads, for PageWriter Touch consisting of 4 chest leads, 4 banana post adapters, 4 shorting plugs, 2 lead separators, 5 colored clip rings and 5 color marked rings, white base rings and 2 assembly instructions.	Length= 24" (61cm)	1 pack= 1 set	Pkg. wt. = 7oz (198g)	860284 (PageWriter Touch)

Cardiology Shielded Replacement Leads - Long
PageWriter Touch, PageWriter Trim

Europe (IEC Color Coding)

Product No.	Description	Packaging Information			Use with Philips Instrument
9898031 29201 CEI	Long limb lead set for PageWriter Touch/Trim, consisting of 2 limb leads, 8 color marked rings, 8 colored base rings, 2 banana plugs, and instruction sheet.	Length= 54" (137cm)	1 pack = 1 set	Pkg. wt. = 2oz (57g)	860284 (PageWr Touch)
9898031 29211 CEI	Long chest lead set for PageWriter Touch/Trim, consisting of 3 chest leads, 12 color marked rings, 3 brown rings, 3 banana adapters, 1 lead separator and instruction sheet.	Length= 39" (99cm)	1 pack = 1 set	Pkg. wt. = 2oz (57g)	860286 860287 860288 860290 (PageWr. Trim)
9898031 29221 CEI	Long complete lead set for PageWriter Touch/Trim, consisting of 4 limb leads, 6 chest leads, 10 color marked rings, 2 lead separators, and instructions.	Length= 54" (137cm) 39" (99cm)	1 pack = 1 set	Pkg. wt. = 7oz (198g)	
9898031 49191 CEI	Upgrade Kit (long) 12-15/16 leads, for PageWriter Touch consisting of 4 long chest leads, 4 banana post adapters, 4 shorting plugs, 2 lead separators, 5 colored clip rings and 5 color marked rings, white base rings and 2 assembly instructions.	Length= 39" (99cm)	1 pack = 1 kit	Pkg. wt. = (.070 kg)	860284 PageWriter Touch



9898031 29191 kit shown with 9898031 29231 Alligator Clips (sold separately)

Cardiology Shielded Replacement Leads
PageWriter XL

U.S. (AAMI Color Coding)

Product Number	Description	Packaging Information		Use with Philips Instrument	
M1711A	Limb lead set for PageWriter XL, consisting of 2 limb leads, 8 color marked rings, 8 colored base rings, and instruction sheet.	Length= 39" (99cm)	1 pack = 1 set	Pkg. wt. = 2oz (57g)	M1700A M1701A M1702A

Cardiology Shielded Replacement Leads
PageWriter XLU.S. (AAMI) and Europe (IEC)
Color Coding

Product Number	Description	Packaging Information		Use with Philips Instrument	
M1712B AAMI	Chest lead set consisting of 3 chest leads, 12 color marked rings, 3 brown rings, and instruction sheet.	Length= 24" (61cm)	1 pack = 1 set	Pkg. wt. = 2oz (57g)	M1700A M1701A M1702A
M1717B AAMI/IEC CEI	Pediatric and Frank lead set consisting of 4 chest leads, color marked rings, 4 banana adapters, and instruction sheet. Can be AAMI or IEC color-coded.	Length= 24" (61cm)		Pkg. wt. = 3oz (85g)	

Cardiology Shielded Replacement Leads
PageWriter XL

Europe (IEC Color Coding)

Product Number	Description	Packaging Information		Use with Philips Instrument	
M1714A CEI	Limb lead set consisting of 2 limb leads, 8 color marked rings, 8 colored base rings, 2 banana plugs, and instructions.	Length=39" (99cm)	1 pack = 1 set	Pkg. wt. = 2oz (57g)	M1700A M1701A M1702A
M1715B CEI	Chest lead set consisting of 3 chest leads, 12 color marked rings, 3 brown rings, 3 banana adapters, 1 lead separator and instructions.	Length=24" (61cm)			

Diagnostic ECG Cable Accessories

Cardiology Cable Accessories

Product Number	Description	Packaging Information		Use with Philips Instrument
40431B CEI	Alligator clip adapters for disposable tab electrodes. Fits on 1/8" post ECG lead terminations. Length: 6" (15cm).	1 pack = 10 adapters	Pkg. wt. = 2oz (57g)	M1700A/M1701A/M1702A M1770A/M1771A, M1772A
40432B IEC CEI	Alligator clip adapters for disposable tab electrodes. Fits on 4mm banana plug lead. Length: 6" (15cm).			
M2254A CEI	Tab electrode adapter to lead wire. Connects tab style electrodes to cardiograph lead wires. Fits on 1/8" post and 4mm banana plug leads. Not available in Japan.	1 pack = 10 adapters	Pkg. wt. = 2oz (57g)	M1700A/M1701A/M1702A M1770A/M1771A, M1772A. M2662A
9898031 29231	Alligator clip adapters for disposable tab electrodes (AAMI).			860284, 860285 PageWriter Touch
9898031 29241 CEI	Alligator clip adapters for disposable tab electrodes (IEC).	1 pack = 10 adapters	Pkg. wt. = 1oz (27g)	860286, 860287, 860288, 860290 PageWriter Trim
9898031 48881	16-Lead spare parts kit for PageWriter Touch. Kit contains: 2 gray and 2 pink marking clips, 5x2 snap-on color rings, 4 banana post adapters, 4 PIM shorting plugs, 2 lead separators and 1 assembly instructions.	1 pack = 1 kit	Pkg. wt. = (.070 kg)	860284 PageWriter Touch



M2254A



40431B



9898031 29231

Cardiography Cable Accessories (continued)

Product Number	Description	Packaging Information		Use with Philips Instrument
40475A CEI	Lead adapter for converting 1/8" post termination to snap electrodes. Color is white. Length: 6-1/2" (17cm).	1 pack = 10 adapters	Pkg. wt. = 3oz (85g)	All 1/8" post terminated leads
40498E IEC CEI	Lead adapter for converting banana plug to grabber connector. For use with snap disposable electrodes and 4mm banana plug termination cables.		Pkg. wt. = 4oz (113g)	All 4mm banana plug leads
M1718A	Shorting plug set consisting of 4 shorting plugs, 10 banana adapters, and 2 lead separators.	1 pack = 1 set	Pkg. wt. = 1oz (28g)	M1700A M1701A M1702A



M1718A



40475E



40498A

EEG Cables and Lead Sets

EEG Cables and Lead Sets

Product Number	Description	Packaging Information		Use with Philips Instrument
M1931A CE See photo	Reusable, color-coded, 5-lead cable with 10-mm silver/silverchloride leadwire cup electrode. Adult lead length: 31.5" (80cm). Use with M1937A electrode conductive paste.	1 pack = 1 lead set	Pkg. wt. = 3.2oz (90g)	M1027A EEG Module
M1932A CE	Reusable, color-coded, 5-lead cable with 6-mm silver/silverchloride leadwire cup electrode. Pediatric/neonatal lead length: 31.5" (80cm). Use with M1937A electrode conductive paste.			
M1934A CE	Reusable, color-coded EEG miniclip 5-lead set with miniclip grabbers. Lead length: 31.5" (80cm). Use with M1935A EEG wet-gel electrodes.	1 pack = set of 5 leads	Pkg. wt. = 3.2oz (136g)	
M2268A CE	EEG shielded trunk cable for 5-lead EEG monitoring. Use with M1931A, M1932A, and M1934A lead sets. Length: 8.8' (2.7m).	1 pack = 1 cable	Pkg. wt. = 9.6oz (269g)	

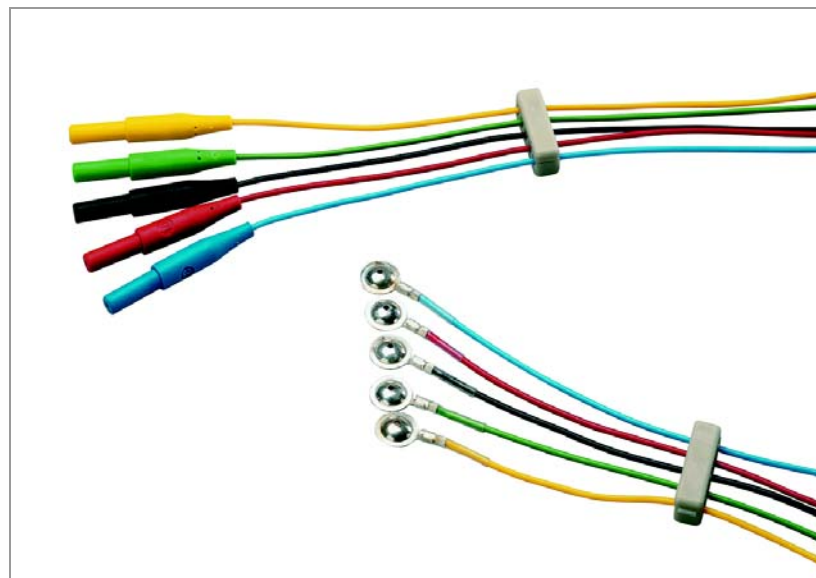

M1931A

MIDA Cables and Leads

MIDA Cables and Leads

Europe (IEC Color Coding)

Product Number	Description	Packaging Information		Use with Philips Instrument
M1950A CEI	10-lead patient trunk cable for MIDA. Use with M1952A and M1953A lead sets. Length: 2m	1 cable	Pkg. wt. = 13 oz (369g)	M2040A, M2045A MIDA System
M1951A CEI	8-lead patient trunk cable for MIDA. Use with M1952A and M1953A lead sets. Length: 2m	1 cable	Pkg. wt. = 9 oz (255g)	
M1952A CEI	5-lead safety lead set for MIDA, grabber connectors. Use with M1950A and M1951A trunk cables. Length: 1.1m	1 lead set	Pkg. wt. = 5 oz (142g)	
M1953A CEI	3/5-lead safety lead set for MIDA, grabber connectors. Includes 5-lead combiner, 5 leads and 2 dummy plugs for 8-lead usage. Use with M1950A and M1951A trunk cables. Length: 1.1m	1 lead set	Pkg. wt. = 5 oz (142g)	
M1955A CEI	2.0m adapter cable. Use to connect M2045A to M1001A/B.	1 cable	Pkg. wt. = 6 oz (171g)	



M1950A

Notes



Chapter 4

Fetal Monitoring Supplies

For Information About	See Page
Fetal Direct ECG Monitoring	4-2
Disposable Belts	4-7
Reusable Belts	4-8
Fetal Belt Buttons and Guides	4-10
Intrauterine Pressure (IUP) Products	4-11
Fetal Monitoring Paper	4-13
Ultrasound Transmission Gel	4-15
Miscellaneous Supplies	4-15

Products labeled with a CE mark indicates compliance with the EU Medical Devices Directive.

Fetal Direct ECG Monitoring

Philips Fetal Scalp Electrodes

Product Number	Description	Packaging Information	Use with:
9898031 37631 CEI	Fetal spiral electrode with protection tab on handle, single spiral. Includes disposable applicator, sterilized. Shelf life: minimum 20 months	1 box = 25 electrodes 1.5 lbs. (.77kg)	9898031 37651 DECG legplate adapter cable for all Philips intrapartum fetal monitors (including legacy Agilent/Hewlett-Packard); 9898031 37791 DECG legplate adapter cable for: GE Corometrics 115, 116, 118, 119, 173, 174 monitors, and can also be used on GE 120, 126, 128, 129, and 250 series monitors when using a GE Corometrics Y-adapter cable 1442AAO or socket adapter 1442BAO;
9898031 37641 CEI	Fetal double spiral electrode with protection tab on handle. Includes disposable applicator, sterilized. Shelf life: minimum 20 months (Europe only)	1 box = 25 electrodes 1.5 lbs. (.78kg)	989803137801 DECG legplate adapter cable for GE Corometrics 120, 126, 128, 129 monitors; 989803137811 DECG legplate adapter cable for Spacelabs IM77 monitors.



989803137631 (single spiral)



989803137641 (double spiral)

Philips DECG Legplate Adapter Cables and Attachment Electrode

Product Number	Description	Packaging Information	Use With:
9898031 37651 CE	DECG legplate adapter cable for 989803137631 & 989803137641 fetal spiral electrodes.	1 cable 12 oz (.35kg)	M1357A DECG transducer with M1347A adapter, M1364-60001, M2738A patient modules, M1365A FSpO ₂ /ECG patient module, M2727A cordless ECG transducer M2735A Toco+ transducer
9898031 37791 CE			GE Corometrics 115, 116, 118, 119, 173, 174
9898031 37801 CE			GE 120, 126, 128, 129, 250 series monitors (using a GE Corometrics Y-adapter cable 1442AA0 or socket adapter 1442BA0)
9898031 37811 CE			GE Corometrics 120, 126, 128, 129
9898031 39771 CE	Attachment electrode, adhesive. Minimum shelf life: 6 months	1 box = 25 electrodes 7oz (.20kg)	9898031 37651, 9898031 37791, 9898031 37801, 9898031 37811 DECG legplate adapter cables only



989803137651



9898031 37791



989803137801



989803137811



989803139771

Qwik Connect Plus™-type Fetal Scalp Electrodes

(Pending Discontinuance)

Product Number	Description	Packaging Information	Use with:
15133E CEI	Fetal scalp electrode, Qwik Connect Plus, single spiral. Includes disposable applicator, sterilized.	1 box = 50 electrodes 3 lbs (1.35kg)	M1362B DECG legplate adapter cable for all Philips intrapartum fetal monitors (including legacy Agilent/Hewlett-Packard).
15133D CEI	Fetal scalp electrode, Qwik Connect Plus, double spiral. Includes disposable applicator, sterilized.	1 box = 25 electrodes 1.3 lbs (.60kg)	

Qwik Connect Plus™-type Legplate Adapter Cable and Attachment Electrode (Pending Discontinuance)

Product Number	Description	Packaging Information	Use With:
M1362B CEI	DECG legplate adapter cable for 15133D/15133E fetal scalp electrodes	1 box = 1 cable 7oz (.20kg)	M1357A DECG transducer with M1347A adapter, M1364-60001, M1365A patient modules, M2735A, M2738A modules M2727A cordless ECG transducer
M1349A CEI	Disposable fetal adhesive pad electrode	1 box = 25 electrodes 2 lb (1.077kg)	M1362B DECG legplate adapter cable only for the 15133D/15133E fetal scalp electrodes

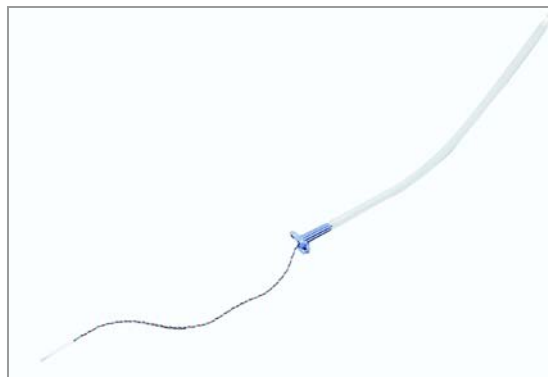

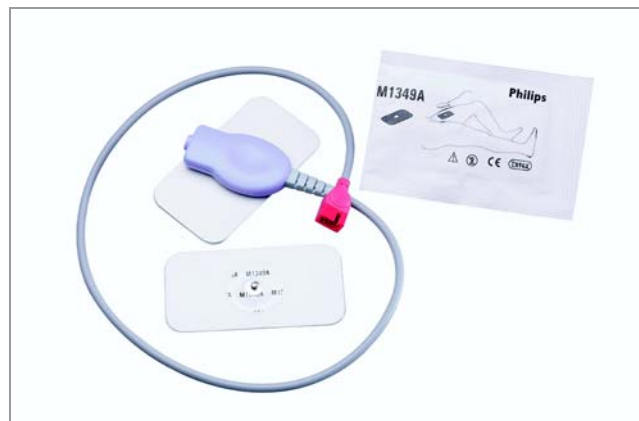

15133E

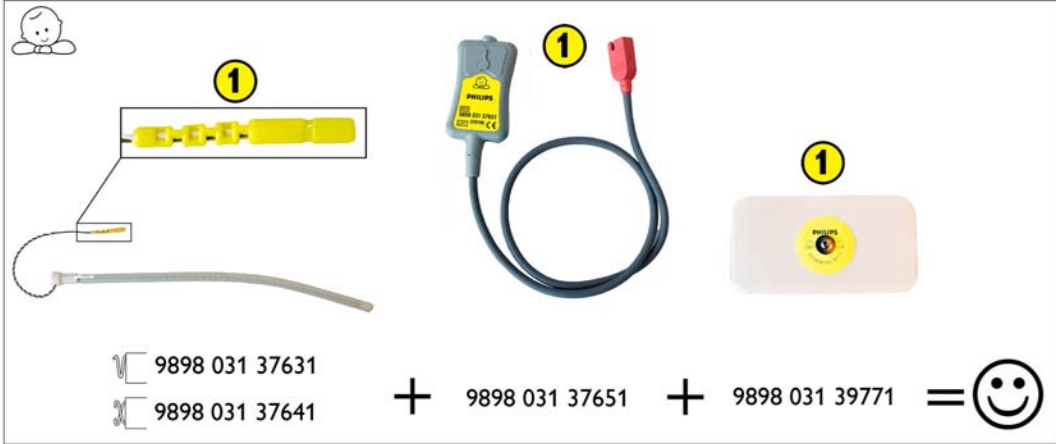

M1362B cable with M1349A electrode

Fetal Scalp Electrode and DECG Legplate Adapter Cable Compatibility

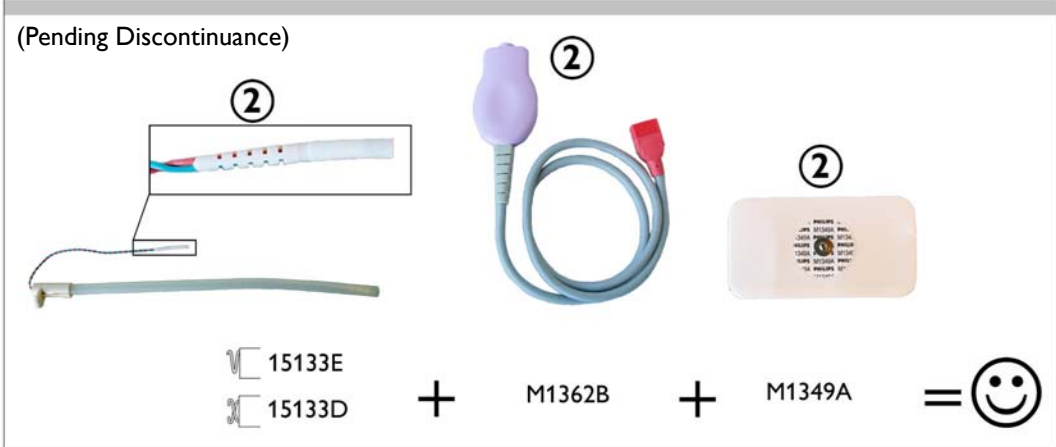
 <p>①</p> <p>9898 031 37631 9898 031 37641</p> <p>①</p> <p>9898 031 37651</p> <p>①</p> <p>9898 031 39771</p> <p>= 😊</p>	 <p>⚠</p> <p>① + ②</p> <p>😊 ☹</p>
<p>(Pending Discontinuance)</p>  <p>②</p> <p>15133E 15133D</p> <p>②</p> <p>M1362B</p> <p>②</p> <p>M1349A</p> <p>= 😊</p>	

Caution: Do not mix (1) and (2) components or the solution will not work.

DECG Transducer and Adapter

Product Number	Description	Packaging Information	Use with:
M1347A CEI	DECG adapter for older monitors	1 adapter 1.8oz (50g)	15240A DECG transducer or M1357A DECG transducer
M1364-60001 CEI	Series 50 ECG Patient Module for Fetal/ Maternal ECG	1 module 8oz (227g)	M1362B or 989803137651 DECG legplate adapter cable for M1350A/B/C, M1353A, M1310A monitors
M2738A CEI	Avalon Patient Module for IUP, Fetal/ Maternal ECG		989803143931 IUP cable or 989803137651 DECG legplate adapter cable for Avalong intrapartum fetal monitors.



M1347A



M2738A

Disposable Belts

Disposable Abdominal Belts

Product No.	Description	Length	Width	Weight/ Case	Philips Transducers and Modules
14328A CEI	Disposable foam abdominal belt. White, soft jersey, backed with Velcro fasteners.	1.4m (55in)	50mm (2in)	50 per case 3.7 lb (1.7kg)	15245A US Transducer 15248A Toco Transducer
M2208A CEI	Yellow, disposable, latex-free elastic abdominal belt. 100 per box with button holes and buttons.	1.3m (52in)	60mm (2.4in)	100 per case 9.4 lb (4.3kg)	15245A US Transducer 15248A Toco Transducer M1355A Toco Transducer M1356A US Transducer M1358A MECG/US Transducer M1364-60001 ECG module M1365A FSpO ₂ /ECG module M2725A Wireless Toco Transducer M2726A Wireless US Transducer M2727A Wireless ECG Transducer M2734A Toco Transducer M2735A Toco+ Transducer M2736A US Transducer M2738A ECG/IUP Module



14328A



M2208A

Reusable Belts

Reusable Abdominal Belts (Pre-cut)

Product No.	Description	Length	Width	Packaging Information	Philips Transducers and Patient Modules
1500-0642 LATEX	Brown elastic, washable abdominal belt with button holes				15245A US Transducer 15248A Toco Transducer M1355A Toco Transducer M1356A US Transducer M1358A MECG/US Transducer M1364A ECG module M1365A FSpO ₂ /ECG module M2725A WirelessToco Transducer M2726A Wireless US Transducer M2727A Wireless ECG Transducer M2734A Toco Transducer M2735A Toco+ Transducer M2736A US Transducer M2738A ECG/IUP Module
M4602A CE	Grey, washable, water resistant, latex-free elastic, pre-cut abdominal belt with button holes.	1.3m (4.25ft)	60mm (2.4in)	5 per box 11oz (312g)	
M1562A CE LATEX	Brown elastic, washable abdominal belt with button holes and pre-attached buttons				15245A US Transducer 15248A Toco Transducer M1355A Toco Transducer M1356A US Transducer M1357A DECG Transducer M1358A MECG/US Transducer M1359A MECG Transducer M1364-60001 ECG Module M1365A FSpO ₂ /ECG Module M2725A WirelessTOCO Transducer M2726A Wireless US Transducer M2727A Wireless ECG Transducer M2734A Toco Transducer M2735A Toco+ Transducer M2736A US Transducer M2738A ECG/IUP Module
M1562B CE	Grey, washable, water resistant, latex-free elastic, pre-cut abdominal belt with button holes.	1.3m (4.25ft)	50mm (2in)	5 per box 9oz (255g)	

Reusable Abdominal Belts, Bulk Rolls

Product No.	Description	Length	Width	Weight	Philips Transducers and Patient Modules
1500-0643 LATEX	Brown elastic, washable abdominal belt with button holes. Must be cut to length.	15m (50ft)	60mm (2.4in)	1 roll per box 1.8lb (0.8kg)	15245A US Transducer 15248A Toco Transducer M1355A Toco Transducer M1356A US Transducer
M4603A CE	Grey, washable, water resistant, latex-free elastic abdominal belt with button holes. Must be cut to length.	15m (50ft)	60mm (2.4in)	1.11 lb (765g)	M1358A US Transducer M1364-60001 ECG Module M1365A FSpO ₂ /ECG Module M2725A Wireless Toco Transducer M2726A Wireless US Transducer M2727A Wireless ECG Transducer M2734A Toco Transducer M2735A Toco+ Transducer M2736A US Transducer M2738A ECG/IUP Module

Reusable Leg Belts, Bulk Roll

Product No.	Description	Length	Width	Weight/Case	Philips Transducers and Patient Modules
1500-0628 LATEX	Brown elastic, washable leg belt with button holes. Must be cut to length.	15.2m (50ft)	32mm (1.25in)	1 roll per box 1lb (454g)	M1364-60001 ECG Module M1365A FSpO ₂ /ECG Module M1357A DECG Module
M4601A CE	Grey, washable, water resistant, latex-free elastic leg belt with button holes. Must be cut to length.	15m (50ft)	32mm (1.25in)	1 roll per box 11oz (312g)	M1359A MECG Module 15240A Direct ECG Transducer M2738A ECG/IUP Module

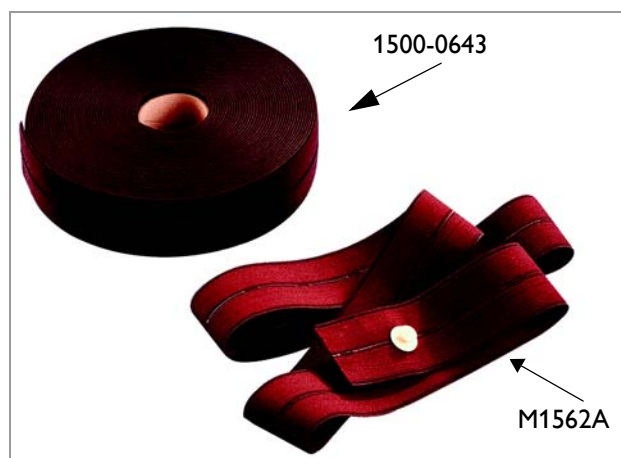

Fetal Belt Buttons and Guides

Belt Buttons

Product No.	Description	Qty/Box	Weight/Box
M1569A	Buttons for fetal belts with button holes	10	1oz (28g)

Belt Guides

Product No.	Description	Qty/Box	Weight/Box
15155-43101	Plastic belt guide for Philips 14328A disposable abdominal belt that is used with the 15245A US Transducer or 15248A Toco Transducer	1	7oz (.20kg)
9898031 43401	Plastic belt clip for M2734A Toco Transducer, M2735A Toco+ transducer, M2736A US Transducer.	6	16oz (.45kg)



9898031 43401 Belt Clip (Toco+ transducer sold separately)

Intrauterine Pressure (IUP) Products

Disposable Sensor-Tip Pressure Catheter

Product Number	Description	Packaging Information		Use with	
M1333A CE See photo	Koala™ disposable sensor-tip IUP catheter, soft, flexible tip, external transducer, transparent catheter tube. Second lumen in the catheter tube allows for amniotic infusion. Connector port included for the saline infusion. Introducer is included.	Internal diaphragm. (Not available from Philips in U.S. and Japan)	1 box = 10 catheters	Pkg. wt. = 14oz (406g)	M1334A or 9898031 43931 connector cable for all Philips intrapartum fetal monitors (including legacy Agilent/Hewlett-Packard)

Connector Cables for IUP Catheter

Product Number	Description	Packaging Information		Use with Philips Instrument
M1334A CE	Reusable connector cable for use with Koala™ disposable sensor-tip IUP catheter.	1 box = 1 cable	Pkg. wt. = 4oz (406g)	8040A M1310A M1350A/B/C M1353A
9898031 43931 CE	Reusable connector cable for use with Koala™ disposable sensor-tip IUP catheter.		Pkg. wt. = 4.6oz (129g)	M2738A Patient Module, M2735A Toco+ Transducer with Philips Avalon intrapartum fetal monitors



M1334A, M1333A



9898031 43931

Reusable Pressure Transducer

Product Number	Description		Packaging	Use with Philips Instrument
CPJ840J5 CE	Memscap Reusable Pressure Transducer	Used for IUP monitoring. Cable length, 3 meters. Includes one transducer holder.	1 transducer per box Pkg. wt. = 1 lb (454g)	M1350B/C M1353A
CPJ84022 CE	Single use sterile domes		Pkg. wt. = 1 lb (.5kg) 50 domes = 1 case	CPJ840J5
CPJ84046 CE	Transducer holder		Pkg. wt. 3oz (91g) 4 per bag	
CPJ84447 CE	IV pole mount		Pkg. wt. = 5.3oz (150g) 1 per pack	

Fetal Monitoring Paper

Chemical/Thermal Paper for Legacy Hewlett-Packard Fetal Monitors

Product Number	Description	Packaging Information		Use with Philips Fetal Monitors	
40470A	Green grid with 1-min. (3cm) highlights. 0-100 mmHg IUP scale, 50-210 FHR scale. Not available in EU countries.	Fetal monitoring chem/therm paper, with "Stop" sign on last page. 3-15/16" x 5-15/16" (100mm x 151mm) (pages numbered)	150 pages/ pack 1 case = 40 packs	Pkg. wt. = 11 lb (4.99 kg)	8025A/B, 8030A, 8031A, 8032A/B, 8040A, 8041A
9270-0484	Green grid with 0-100 mmHg IUP scale, 50-210 FHR scale.		150 pages/ pack 1 case = 50 packs	Pkg. wt. = 12 lb (5.44kg)	8030A, 8031A, 8040A, 8041A, 8032A/B
9270-0485	Orange grid with 1-min. (3cm) highlights. 0-100 mmHg IUP scale, 30-240 FHR scale.				
9270-0630-050	Green grid with 0-100 mmHg scale, plus 0-13 kPa scale, 50-210 FHR scale.			Pkg. wt. = 17 lb 1oz (7.74kg)	8030A, 8031A, 8040A, 8041A

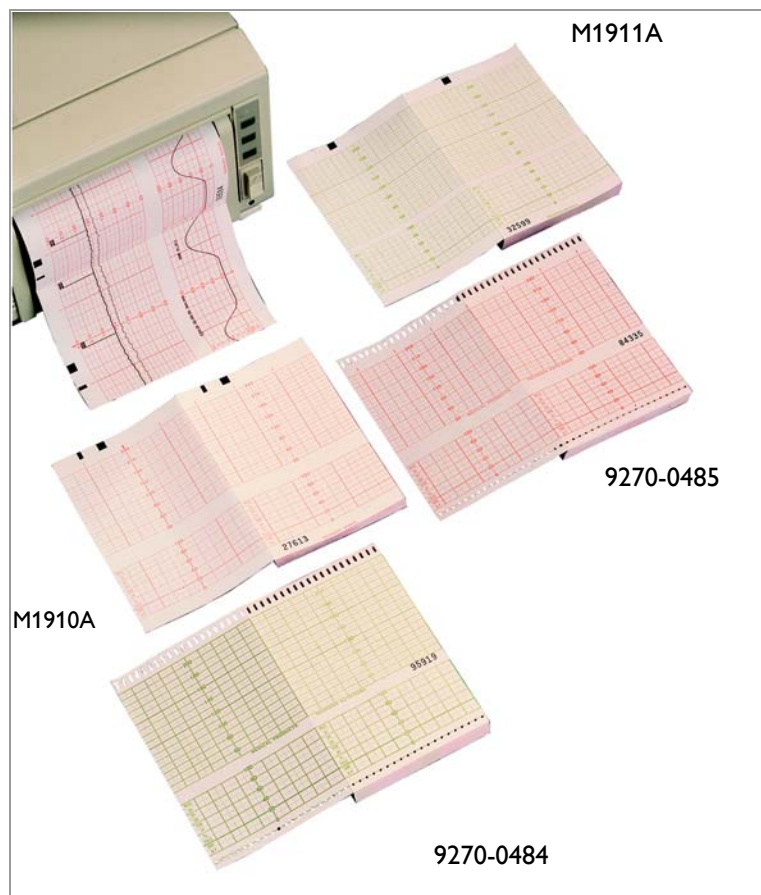

Chemical/Thermal Paper for Fetal Monitors

Product Number	Description	Packaging Information		Use with Philips Fetal Monitors
M1910A CEI See photo	Chem/therm paper, orange grid with 1-min. (3cm) highlights. 0-100 mmHg IUP scale, 30-240 FHR scale, 150 sheets per pack.	Fetal monitoring paper, with "Stop" sign on last page	1 case = 40 packs	Pkg. wt. = 11lb 7oz (5.19kg)
M1911A CEI See photo	Chem/therm paper, green grid with 0-100 mmHg IUP scale, plus 0-13 kPa scale, 50-210 FHR scale, 150 sheets per pack.			
M1913A	Chem/therm paper, green grid with 1-min. (3cm) highlights. 0-100 mmHg IUP scale, 50-210 FHR scale, 150 sheets per pack.	Fetal monitoring paper, with "Stop" sign on last page	1 case = 40 packs	Pkg. wt. = 11lb 7oz (5.19kg)
M1913J	Chem/therm paper (for Japan only). Green grid with 1-min. (3cm) highlights. 0-100 mmHg IUP scale, 50-210 FHR scale.	No "Stop" sign, color shading on FHR scale		

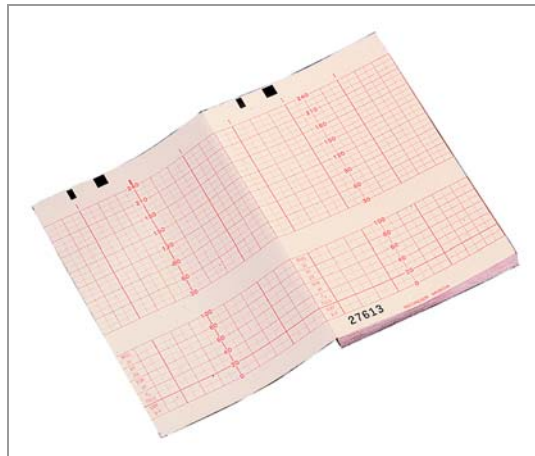

M1910A

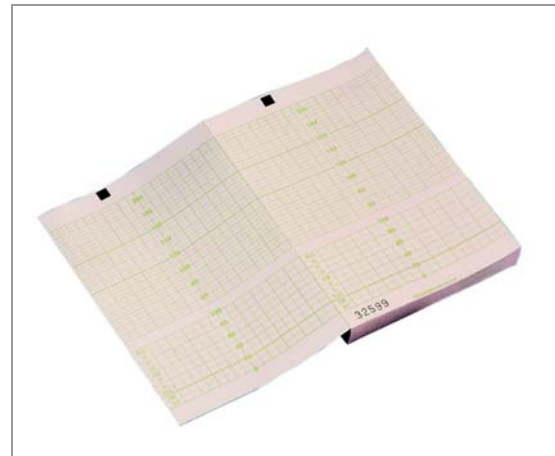

M1911A

Ultrasound Supplies

Ultrasound Transmission Gel

Product Number	Description	Packaging Information			Use with Philips Instrument
40483A CE See photo	Ultrasound transmission gel. Water soluble, easy patient cleanup. Plastic 8-1/2oz (0.25 l) refillable squeeze bottles. Order refill 40483B below.	1 box = 12 bottles	Pkg. wt. = 8 lbs. (3.62kg)	Shelf life: At least 6 months	Ultrasound transducers
40483B CE	Ultrasound transmission gel. Water soluble, easy patient cleanup. Large dispenser size, 5 liter container, used to refill 40483A above.	1 box = 5 liter	Pkg. wt. = 11 lbs. 15oz (5.41kg)		

Miscellaneous Supplies

Miscellaneous Fetal Monitoring Supplies

Product No.	Description	Qty/Box	Weight/Box	Use with Philips Products
M1531B CE	Maternal ECG leads for use with M1359A MEEG transducer.	4 leads	1oz (28g)	M1350A/B M1353A, M2735A
M1363A CE	MEEG adapter cable with reusable lead set.	1	.39oz (11g)	M1364A, M1365A, M2727A, M2738A
M4503A	Fetal Monitoring Record file, contains instructions, 5 sets of tabs, 60 record wrappers, 120 patient record labels, 40 Antepartum record labels, 60 Delivery labels, 60 monitoring record labels, 1 file box label, (paper not included). Not available in Europe.	1 box = 1 kit	Pkg. wt. = 1 lb (454g)	--
M3919A	Canvas tote bag for the M2922A Portable Antepartum fetal monitor (FM2)		2.3 lbs. (1kg)	M3919A
9898031 43411 CE	Avalon Event Marker	1	2 lbs. (0.98kg)	Avalon fetal monitors

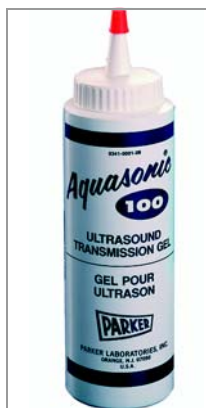

40483A



M1363A



989803143411

Fetal Monitoring Kits

Standard Antepartum Kits

Product No.	Description	Weight/Box	Use with Philips Instruments
862214	Kit contains: M1569A Belt Buttons (quantity 10) M1910A Fetal Paper (40/1 case) 40483A Ultrasound gel (quantity 12 bottles) M2208A Disposable Abdominal Fetal Belt (100/1 case) 989803143401 Belt Clip for Toco+ (6 clips) For shipments to North America only.	29 lbs. (12.07kg)	Avalon fetal monitors
862215	Kit contains: M1569A Belt Buttons (quantity 10) M1911A Fetal Paper (40/case) 40483A Ultrasound gel (quantity 12 bottles) M4602A Reusable Abdominal Belt (5 belts) 989803143401 Belt Clip for Toco+ (6 clips) For shipments to Europe, Latin America and Asia only.	20 lbs. (9.28kg)	
862216	Kit contains: M1569A Belt Buttons (quantity 10) M1913J Fetal Paper (40/1 case) 40483A Ultrasound gel (quantity 12 bottles) M2208A Disposable Abdominal Fetal Belt (100/1 case) 989803143401 Belt Clip for Toco+ (6 clips) For shipments to Japan only.	28 lbs. (12.04kg)	

Intrapartum DECG Kits

Product No.	Description	Weight/Box	Use with Philips Products
862217	Kit contains: 989803137631 Fetal (Single) Spiral Electrodes (quantity 25) 989803139771 Attachment Electrode (quantity 25)	2 lbs. (0.98kg)	989803137651 Legplate Adapter
862218	Kit contains: 989803137641 Fetal Double Spiral Electrodes (quantity 25) 989803139771 Attachment Electrode (quantity 25)		

Notes



Chapter 5 Invasive Blood Pressure Supplies

For Information About	See Page
Memscap Pressure Transducers	5-2
Blood Pressure Kits	5-3

Products labeled with a CE mark indicates compliance with the EU Medical Devices Directive.

Memscap Pressure Transducers

CPJ840J5 and CPJ840J6 Memscap Pressure Transducers and Accessories

Product Number	Description		Packaging	Use with Philips Instrument
CPJ840J5 CE	Memscap Reusable Pressure Transducer	Used for IUP monitoring. Cable length 3 meters. Includes one transducer holder.		M1350B/C M1353A
CPJ840J6 CE See photo	Memscap Reusable Pressure Transducer	Used to measure arterial and venous blood pressure. Cable length 3 meters. Includes one transducer holder.	1 transducer per box Pkg. wt. = 1 lb (454g)	M1006A/B M3000A M3001A M3002A M3012A M3014A M3016A M8102A M8105A 863065 863066 863068 M3535A/M3536A with Opt. A06
CPJ84022 CE See photo	Single use sterile domes		Pkg. wt. = 1 lb (.5kg) 50 domes = 1 case	
CPJ84026 CE	Lines set for CPJ840J6 transducer, sterilized. Not available in all countries. Contact your local sales office.		10 per pack	CPJ840J5 CPJ840J6
CPJ84046 CE	Transducer holder		Pkg. wt. 3oz (91g) 4 per bag	
CPJ84447 CE	IV pole mount		Pkg. wt. = 5.3oz (150g) 1 per pack	



CPJ840J5 Transducer with CPJ84022 Dome

Blood Pressure Kits

Blood Pressure Kits - Europe

Product Number	Description	Packaging		Use with Philips Instrument
M1567A CE	Single line blood pressure kit. Contains one disposable pressure transducer (DPT), infusion set, tube, stopcocks, flushing device, and continuous flow system.			All invasive pressure monitors including: M3535A/ M3536A HeartStart MRx Opt. A06 (Defibrillator/ Monitor)
M1568A CE	Dual line blood pressure kit for measuring CVP, ABP and other vascular pressure measurements. Contains one disposable pressure transducer (DPT), infusion set, red and blue color coded tubing, stopcocks, flushing device, and continuous flow system.	1 box= 20 kits	Pkg. wt. = 2 lb 2oz (1kg)	
M1634A CE	Reusable adapter cable, for M1567A and M1568A kits.	1 box= 1 cable	Pkg. wt. = 6oz (170g)	
M2271A	Holder for disposable pressure transducer (DPT). Holds up to four DPTs. Requires M2272A pole mount.	1 box= 1 holder	Pkg. wt. = 3.5oz (100g)	
M2272A	IV pole mount. Supports one M2271A holder and clamps to IV pole.	1 box= 1 mount	Pkg. wt. = 8.5oz (238g)	

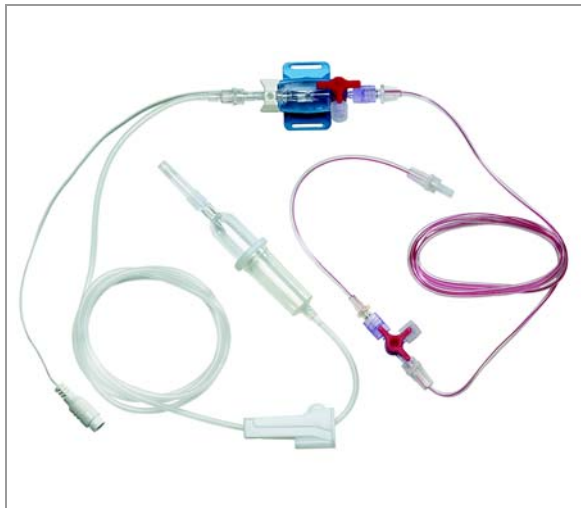

M1567A Single line BP kit

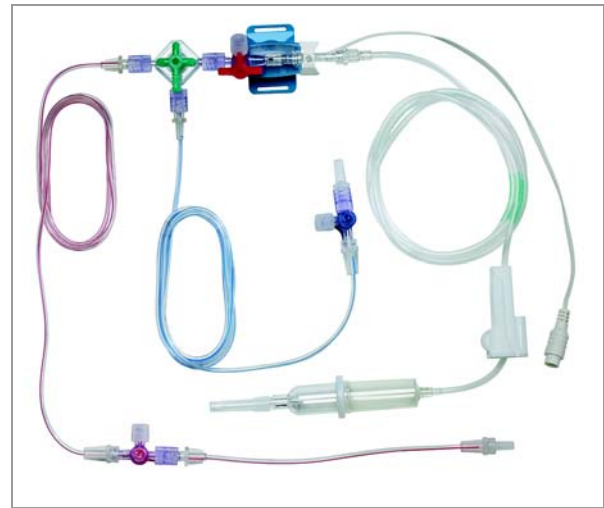

M1568A Dual line BP kit

Notes



Chapter 6

Non-Invasive Blood Pressure Supplies

<i>For Information About</i>	<i>See Page</i>
Reusable NIBP Cuffs: Latex-Free	6-2
Disposable NIBP Cuffs: Latex-Free	6-13
NIBP Interconnect Tubing	6-17
NIBP Cuff Adapters	6-19
Neonatal NIBP Cuffs: Latex Free	6-21
Neonatal Interconnect Tubing	6-22

Products labeled with a CE mark indicates compliance with the EU Medical Devices Directive.

Reusable NIBP Cuffs: Latex-Free

- Use appropriate NIBP tubing for specified monitors listed on page 6-17
- See “Philips NIBP Cuff Adapters” on page 6-19 for adaptability of cuffs to other manufacturer’s brand instruments.

Multi-Patient Comfort (Reusable) Cuffs

Product Number	Description		Packaging Information	Use with Philips Instrument
M1571A C€	Infant size	Bladder width = 2.2” (5.5cm) Bladder length = 5.9” (15cm) Limb circumference = 10cm to 15cm	Pkg. wt. = 1oz (28g) Qty. = 1 cuff	78352A/C, 78354A/C 862474, 862478 (C3) 863055 to 863062 (VS1) M1008A/B Modules M3000A, M3001A, M3002A SureSigns VM4, VM6, VM8, VS3 M8102A, M8105A (MP2, MP5)
M1572A C€	Pediatric size	Bladder width = 3.1” (8cm) Bladder length = 8.5” (21.5cm) Limb circumference = (14cm to 21.5cm)	Pkg. wt. = 1.4oz (40g) Qty. = 1 cuff	78352A/C, 78354A/C 862474, 862478 (C3) 863055 to 863062 (VS1) M2636B/C (TeleMon B/C) M1008A/B Modules M3000A, M3001A, M3002A M3535A, M3536A (HeartStart MRx) M8102A, M8105A (MP2, MP5) SureSigns VM4, VM6, VM8, VS3
M1573A C€	Small adult size	Bladder width = 4.1” (10.5cm) Bladder length = 9.4” (24cm) Limb circumference = (20.5cm to 28cm)	Pkg. wt. = 2oz (57g) Qty. = 1 cuff	78352A/C, 78354A/C 862474, 862478 (C3) 863055 to 863062 (VS1) M2636B/C (TeleMon B/C)
M1574A C€	Adult size	Bladder width = 5.1” (13cm) Bladder length = 11” (28cm) Limb circumference = (27cm to 35cm)	Pkg. wt. = 2.6oz (74g) Qty. = 1 cuff	M1008A/B Modules M1350B/C Fetal Monitors M2702A, M2703A (Avalon) M3000A, M3001A, M3002A
M1575A C€	Large adult size	Bladder width = 6.3” (16cm) Bladder length = 13.8” (35cm) Limb circumference = (34cm to 43cm)	Pkg. wt. = 3.7oz (106g) Qty. = 1 cuff	M3535A, M3536A (HeartStart MRx) M8102A, M8105A (MP2, MP5) SureSigns VM4, VM6, VM8, VS3
M1576A C€	Thigh size	Bladder width = 7.9” (20cm) Bladder length = 16.9” (43cm) Limb circumference = (42cm to 54cm)	Pkg. wt. = 5.5oz (157g) Qty. = 1 cuff	862474, 862478 (C3) 863055 to 863062 (VS1) M1008A/B Modules M1350B/C Fetal Monitors M2702A, M2703A (Avalon) M3000A, M3001A, M3002A M8102A, M8105A (MP2, MP5)

Multi-Patient Comfort (Reusable) Cuff Kits

Product Number	Description	Packaging Information	Use with Philips Instrument
M1577A CE	Kit containing 4 smaller cuffs (M1571A-M1574A). Recommended for pediatric ICU or OR.	Pkg. wt. = 7oz (197g) Qty. = 4 cuffs	78352A/C, 78354A/C 862474, 862478 (C3) 863055 to 863062 (VS1) M1008A/B Modules M3000A, M3001A, M3002A M8102A, M8105A (MP2, MP5)
M1579A CE	Kit containing all 6 cuffs (M1571A-M1576A). Useful for mixed patient units (e.g. ER, PACU, SICU).	Pkg. wt. = 16.2oz (460g) Qty. = 6 cuffs	78352A/C, 78354A/C 862474, 862478 (C3) 863055 to 863062 (VS1) M1008A/B Modules M3000A, M3001A, M3002A M8102A, M8105A (MP2, MP5)
M1578A CE	Kit containing 4 larger cuffs (M1573A-M1576A). Recommended for adult ICU or OR.	Pkg. wt. = 13.8oz (397g) Qty. = 4 cuffs	78352A/C, 78354A/C 862474, 862478 (C3) 863055 to 863062 (VS1) M1008A/B Modules M1350B/C Fetal Monitors M2702A, M2703A (Avalon) M3000A, M3001A, M3002A M8102A, M8105A (MP2, MP5)

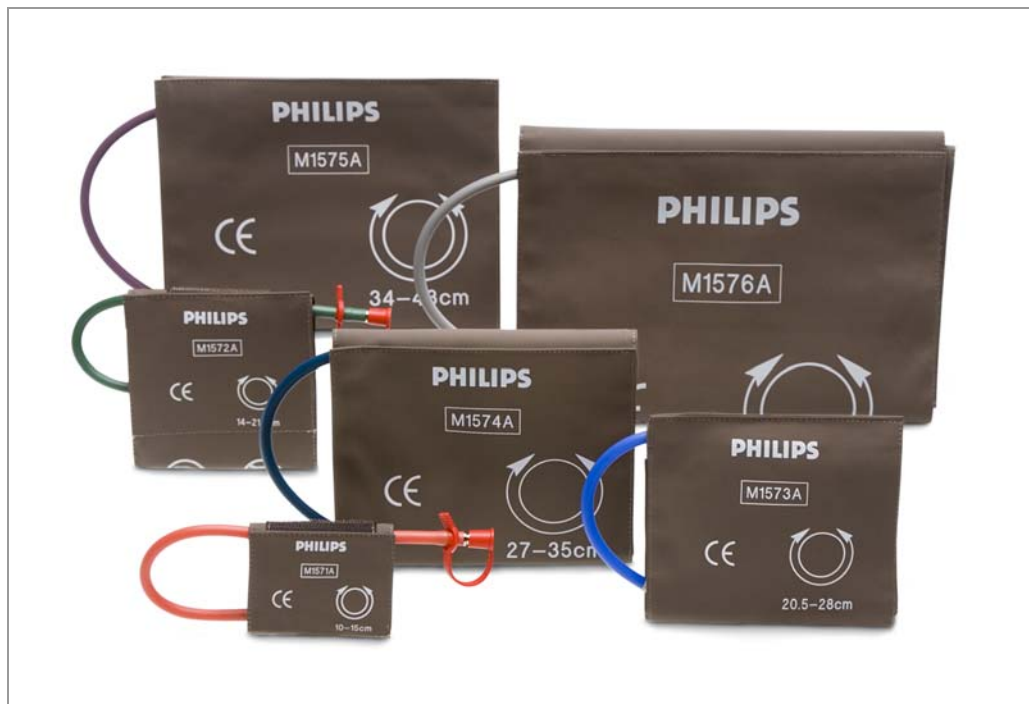

M1576A, M1575A, M1574A, M1573A, M1572A, M1571A

Antimicrobial Coated (Reusable) Cuffs - Single Hose Models

- Use appropriate NIBP tubing for specified monitors listed on page 6-17

Product Number	Size (Color)	Description	Packaging Information	Use with Philips Instrument
M4552A ☒ photo next page	Infant (Orange)	Bladder width = 2.1" (5.4cm) Bladder length = 4.8" (12.3cm) Limb circumference = 9-14.8cm	Pkg. wt. = 1.3oz (37g) Qty: 1 cuff	78352A/C, 78354A/C 863051 to 863054 (C1) 863055 to 863062 (VS1) M1008A/B Modules M3000A, M3001A M3535A, M3536A (HS MRx) SureSigns VM4, VM6, VM8
M4553A ☒ photo next page	Pediatric (Green)	Bladder width = 3.1" (8cm) Bladder length = 7.1" (18.1cm) Limb circumference = 13.8-21.5cm	Pkg. wt. = 1.6oz (46g) Qty: 1 cuff	78352A/C, 78354A/C 863051 to 863054 (C1) 863055 to 863062 (VS1) M1008A/B Modules M3000A, M3001A M3535A, M3536A (HS MRx) SureSigns VM4, VM6, VM8
M4554A ☒ photo next page	Small Adult (Light Blue)	Bladder width = 4.2" (10.6cm) Bladder length = 9.4" (23.9cm) Limb circumference = 20.9-28.5cm	Pkg. wt. = 2.4oz (69g) Qty: 1 cuff	78352A/C, 78354A/C 863051 to 863054 (C1) 863055 to 863062 (VS1) M1008A/B Modules M1350B/C Fetal Monitors M2702A, M2703A (Avalon) M3000A, M3001A M3535A, M3536A (HS MRx) SureSigns VM4, VM6, VM8
M4555A ☒ photo next page	Adult (Navy Blue)	Bladder width = 5.3" (13.5cm) Bladder length = 12.1" (30.7cm) Limb circumference = 27.5-36.5cm Cuff cover length = 20.5" (52.2cm)	Pkg. wt. = 2.7oz (77g) Qty: 1 cuff	M1008A/B M3000A, M3001A SureSigns VM4, VM6, VM8
M4557A ☒ photo next page	Large Adult (Burgundy)	Bladder width = 6.7" (17cm) Bladder length = 15.2" (38.6cm) Limb circumference = 35.5-46cm Cuff cover length = 25.8" (65.5cm)	Pkg. wt. = 3.5oz (100g) Qty: 1 cuff	M1008A/B M3000A, M3001A SureSigns VM4, VM6, VM8
M4556A ☒ photo next page	Adult Extra-Long* (Navy Blue)	Bladder width = 5.3" (13.5cm) Bladder length = 12.1" (30.7cm) Limb circumference = 27.5-36.5cm Cuff cover length = 25.8" (65.5cm)	Pkg. wt. = 3.2oz (92g) Qty: 1 cuff	M1008A/B M3000A, M3001A SureSigns VM4, VM6, VM8
M4558A ☒ photo next page	Large Adult Extra-Long* (Burgundy)	Bladder width = 6.7" (17cm) Bladder length = 15.2" (38.6cm) Limb circumference = 35.5-46cm Cuff length = 32.9" (83.5cm)	Pkg. wt. = 4.2oz (120g) Qty: 1 cuff	M1008A/B M3000A, M3001A SureSigns VM4, VM6, VM8
M4559A ☒ photo next page	Thigh (Grey)	Bladder width = 8.3" (21cm) Bladder length = 18.7" (47.5cm) Limb circumference = 45-56.5cm	Pkg. wt. = 5oz (143g) Qty: 1 cuff	78352A/C, 78354A/C 863051 to 863054 (C1) 863055 to 863062 (VS1) M1008A/B Modules M1350B/C Fetal Monitors M2702A, M2703A (Avalon) M3000A, M3001A M3535A, M3536A (HS MRx) SureSigns VM4, VM6, VM8

* Accuracy is dependent on proper application according to cuff labeling



M4552A, M4553A, M4554A, M4555A, M4557A, M4559A

Antimicrobial Coated (Reusable) Cuffs - Double Hose Models

- Use other manufacturers' NIBP tubing along with appropriate Philips adapter.

Product Number	Size (Color)	Description	Packaging Information	Use with Philips Instrument
M4562A CE	Infant (Orange)	Bladder width = 2.1" (5.4cm) Bladder length = 4.8" (12.3cm) Limb circumference = 9-14.8cm	Pkg. wt. = 9.3oz (263.1g) Qty. = 1 cuff	For use with Double-Hose Monitors. See page 6-19 for adaptability of cuffs to Philips and additional manufacturers' brand instruments.
M4563A CE	Pediatric (Green)	Bladder width = 3.1" (8cm) Bladder length = 7.1" (18.1cm) Limb circumference = 13.8-21.5cm	Pkg. wt. = 10.5oz (297.1g) Qty. = 1 cuff	
M4564A CE	Small Adult (Light Blue)	Bladder width = 4.2" (10.6cm) Bladder length = 9.4" (23.9cm) Limb circumference = 20.9-28.5cm	Pkg. wt. = 12.9oz (365.1g) Qty. = 1 cuff	
M4565A CE	Adult (Navy Blue)	Bladder width = 5.3" (13.5cm) Bladder length = 12.1" (30.7cm) Limb circumference = 27.5-36.5cm Cuff cover length = 20.5" (52.2cm)	Pkg. wt. = 1.2 lbs. (539.8g) Qty. = 1 cuff	
M4566A CE	Adult Extra-Long* (Navy Blue)	Bladder width = 5.3" (13.5cm) Bladder length = 12.1" (30.7cm) Limb circumference = 27.5-36.5cm Cuff cover length = 25.8" (65.5cm)	Pkg. wt. = 1.4 lbs. (630.5g) Qty. = 1 cuff	
M4567A CE	Large Adult (Burgundy)	Bladder width = 6.7" (17cm) Bladder length = 15.2" (38.6cm) Limb circumference = 35.5-46cm Cuff cover length = 25.8" (65.5cm)	Pkg. wt. = 1.6 lbs. (718.5g) Qty. = 1 cuff	
M4568A CE	Large Adult Extra-Long* (Burgundy)	Bladder width = 6.7" (17cm) Bladder length = 15.2" (38.6cm) Limb circumference = 35.5-46cm Cuff length = 32.9" (83.5cm)	Pkg. wt. = 5.1oz (45g) Qty. = 1 cuff	
M4569A CE	Thigh (Grey)	Bladder width = 8.3" (21cm) Bladder length = 18.7" (47.5cm) Limb circumference = 45-56.5cm	Pkg. wt. = 5.4oz (155g) Qty. = 1 cuff	

* Accuracy is dependent on proper application according to cuff labeling

New Antimicrobial Coated (Reusable) Cuffs - Single Hose Models (Not Available in the U.S.)

- Use appropriate NIBP tubing for specified monitors listed on page 6-17

Product Number	Size (Color)	Description	Packaging Information	Use with Philips Instrument
M4552B CE photo: page 6-9	Infant (Orange)	Bladder width = 2.2" (5.5cm) Bladder length = 5.9" (15cm) Limb circumference = 10-15cm Cuff length: 8.7" (22cm)	Pkg. wt. = 2.9oz (83g) Qty: 1 cuff	78352A/C, 78354A/C 863051 to 863054 (C1) 862474, 862478 (C3) 863055 to 863062 (VS1) M1008A/B Modules M3000A, M3001A, M3002A M3535A, M3536A (HS MRx) M8102A, M8105A (MP2, MP5) SureSigns VM4, VM6, VM8, VS3
M4553B CE photo: page 6-9	Pediatric (Green)	Bladder width = 3.1" (8cm) Bladder length = 8.5" (21.5cm) Limb circumference = 14-21.5cm Cuff length: 12.2" (31cm)	Pkg. wt. = 3.2oz (89.8g) Qty: 1 cuff	78352A/C, 78354A/C 863051 to 863054 (C1) 862474, 862478 (C3) 863055 to 863062 (VS1) M1008A/B Modules M2636B/C TeleMon B/C M3000A, M3001A, M3002A M3535A, M3536A (HS MRx) M8102A, M8105A (MP2, MP5) SureSigns VM4, VM6, VM8, VS3
M4554B CE photo: page 6-9	Small Adult (Light Blue)	Bladder width = 4.2" (10.6cm) Bladder length = 9.4" (24cm) Limb circumference = 20.5-28.5cm Cuff length: 16.5" (42cm)	Pkg. wt. = 3.6oz (103.4g) Qty: 1 cuff	
M4555B CE photo: page 6-9	Adult (Navy Blue)	Bladder width = 5.3" (13.5cm) Bladder length = 11.8" (30cm) Limb circumference = 27.5-36cm Cuff length = 20.7" (52.5cm)	Pkg. wt. = 4.3oz (121.6g) Qty: 1 cuff	78352A/C, 78354A/C 863051 to 863054 (C1) 862474, 862478 (C3) 863055 to 863062 (VS1)
M4556B CE photo: page 6-9	Adult Extra-Long* (Navy Blue)	Bladder width = 5.3" (13.5cm) Bladder length = 11.8" (30cm) Limb circumference = 27.5-36cm Cuff length = 26" (66cm)	Pkg. wt. = 5.1oz (144.2g) Qty: 1 cuff	M1008A/B Modules M1350B/C Fetal Monitors M2702A, M2703A (Avalon) M2636B/C (TeleMon B/C) M3000A, M3001A, M3002A M3535A, M3536A (HS MRx)
M4557B CE photo: page 6-9	Large Adult (Burgundy)	Bladder width = 6.7" (17cm) Bladder length = 15" (38cm) Limb circumference = 35-45cm Cuff length = 26.2" (66.5cm)	Pkg. wt. = 5.3oz (151g) Qty: 1 cuff	M8102A, M8105A (MP2, MP5) SureSigns VM4, VM6, VM8, VS3
M4558B CE photo: page 6-9	Large Adult Extra-Long* (Burgundy)	Bladder width = 6.7" (17cm) Bladder length = 15" (38cm) Limb circumference = 35-45cm Cuff length = 32.9" (83.5cm)	Pkg. wt. = 6.1oz (173.7g) Qty: 1 cuff	
M4559B CE photo: page 6-9	Thigh (Grey)	Bladder width = 8.3" (21cm) Bladder length = 18.9" (48cm) Limb circumference = 44-56cm Cuff length = 33.1" (84cm)	Pkg. wt. = 7oz (198.7g) Qty: 1 cuff	78352A/C, 78354A/C 863051 to 863054 (C1) 862474, 862478 (C3) 863055 to 863062 (VS1) M1008A/B Modules M1350B/C Fetal Monitors M2702A, M2703A (Avalon) M3000A, M3001A, M3002A M3535A, M3536A (HS MRx) M8102A, M8105A (MP2, MP5) SureSigns VM4, VM6, VM8, VS3

* Accuracy is dependent on proper application according to cuff labeling

New Antimicrobial Coated (Reusable) Cuffs (5 Packs) - Single Hose Models (Not Available in the U.S.)

- Use appropriate NIBP tubing for specified monitors listed on page 6-17

Product Number	Size (Color)	Description	Packaging Information	Use with Philips Instrument
M4552B5 CE	Infant (Orange)	Bladder width = 2.2" (5.5cm) Bladder length = 5.9" (15cm) Limb circumference = 10-15cm Cuff length: 8.7" (22cm)	Pkg. wt. = 9.3oz (263.1g) Qty. = 5 cuffs	78352A/C, 78354A/C 863051 to 863054 (C1) 862474, 862478 (C3) 863055 to 863062 (VS1) M1008A/B Modules M3000A, M3001A, M3002A M3535A, M3536A (HS MRx) M8102A, M8105A (MP2, MP5) SureSigns VM4, VM6, VM8, VS3
M4553B5 CE	Pediatric (Green)	Bladder width = 3.1" (8cm) Bladder length = 8.5" (21.5cm) Limb circumference = 14-21.5cm Cuff length: 12.2" (31cm)	Pkg. wt. = 10.5oz (297.1g) Qty. = 5 cuffs	78352A/C, 78354A/C 863051 to 863054 (C1) 862474, 862478 (C3) 863055 to 863062 (VS1) M1008A/B Modules M2636B/C TeleMon B/C M3000A, M3001A, M3002A M3535A, M3536A (HS MRx) M8102A, M8105A (MP2, MP5) SureSigns VM4, VM6, VM8, VS3
M4554B5 CE	Small Adult (Light Blue)	Bladder width = 4.2" (10.6cm) Bladder length = 9.4" (24cm) Limb circumference = 20.5-28.5cm Cuff length: 16.5" (42cm)	Pkg. wt. = 12.9oz (365.1g) Qty. = 5 cuffs	
M4555B5 CE	Adult (Navy Blue)	Bladder width = 5.3" (13.5cm) Bladder length = 11.8" (30cm) Limb circumference = 27.5-36cm Cuff length = 20.7" (52.5cm)	Pkg. wt. = 1.2 lbs. (539.8g) Qty. = 5 cuffs	78352A/C, 78354A/C 863051 to 863054 (C1) 862474, 862478 (C3) 863055 to 863062 (VS1)
M4556B5 CE	Adult Extra-Long* (Navy Blue)	Bladder width = 5.3" (13.5cm) Bladder length = 11.8" (30cm) Limb circumference = 27.5-36cm Cuff length = 26" (66cm)	Pkg. wt. = 1.4 lbs. (630.5g) Qty. = 5 cuffs	M1008A/B Modules M1350B/C Fetal Monitors M2702A, M2703A (Avalon) M2636B/C (TeleMon B/C) M3000A, M3001A, M3002A M3535A, M3536A (HS MRx)
M4557B5 CE	Large Adult (Burgundy)	Bladder width = 6.7" (17cm) Bladder length = 15" (38cm) Limb circumference = 35-45cm Cuff length = 26.2" (66.5cm)	Pkg. wt. = 1.6 lbs. (718.5g) Qty. = 5 cuffs	M8102A, M8105A (MP2, MP5) SureSigns VM4, VM6, VM8, VS3
M4558B5 CE	Large Adult Extra-Long* (Burgundy)	Bladder width = 6.7" (17cm) Bladder length = 15" (38cm) Limb circumference = 35-45cm Cuff length = 32.9" (83.5cm)	Pkg. wt. = 1.8 lbs. (831.9g) Qty. = 5 cuffs	
M4559B5 CE	Thigh (Grey)	Bladder width = 8.3" (21cm) Bladder length = 18.9" (48cm) Limb circumference = 44-56cm Cuff length = 33.1" (84cm)	Pkg. wt. = 2.1 lbs. (956.6g) Qty. = 5 cuffs	78352A/C, 78354A/C 863051 to 863054 (C1) 862474, 862478 (C3) 863055 to 863062 (VS1) M1008A/B Modules M1350B/C Fetal Monitors M2702A, M2703A (Avalon) M3000A, M3001A, M3002A M3535A, M3536A (HS MRx) M8102A, M8105A (MP2, MP5) SureSigns VM4, VM6, VM8, VS3

* Accuracy is dependent on proper application according to cuff labeling



New Antimicrobial Coated Reusable NIBP Cuffs - Single Hose (Not Available in the U.S.)

New Antimicrobial Coated (Reusable) NIBP Cuffs - Double Hose Models (Not Available in the U.S.)

- Use other manufacturers' NIBP tubing along with appropriate Philips adapter.

Product Number	Size (Color)	Description	Packaging Information	Use With Other Manufacturers' Instrument
M4562B CE	Infant (Orange)	Bladder width = 2.2" (5.5cm) Bladder length = 5.9" (15cm) Limb circumference = 10-15cm Cuff length: 8.7" (22cm)	Pkg. wt. = 3.1oz (88.9g) Qty. = 1 cuff	For use with Double-Hose Monitors. See page 6-19 for adaptability of cuffs to Philips and additional manufacturers' brand instruments.
M4563B CE	Pediatric (Green)	Bladder width = 3.1" (8cm) Bladder length = 8.5" (21.5cm) Limb circumference = 14-21.5cm Cuff length: 12.2" (31cm)	Pkg. wt. = 3.5oz (98g) Qty. = 1 cuff	
M4564B CE	Small Adult (Light Blue)	Bladder width = 4.2" (10.6cm) Bladder length = 9.4" (24cm) Limb circumference = 20.5-28.5cm Cuff length: 16.5" (42cm)	Pkg. wt. = 3.9oz (111.6g) Qty. = 1 cuff	
M4565B CE	Adult (Navy Blue)	Bladder width = 5.3" (13.5cm) Bladder length = 11.8" (30cm) Limb circumference = 27.5-36cm Cuff length = 20.7" (52.5cm)	Pkg. wt. = 4.6oz (129.7g) Qty. = 1 cuff	
M4566B CE	Adult Extra-Long* (Navy Blue)	Bladder width = 5.3" (13.5cm) Bladder length = 11.8" (30cm) Limb circumference = 27.5-36cm Cuff length = 26" (66cm)	Pkg. wt. = 5.3oz (150.1g) Qty. = 1 cuff	
M4567B CE	Large Adult (Burgundy)	Bladder width = 6.7" (17cm) Bladder length = 15" (38cm) Limb circumference = 35-45cm Cuff length = 26.2" (66.5cm)	Pkg. wt. = 5.5oz (156.9g) Qty. = 1 cuff	
M4568B CE	Large Adult Extra-Long* (Burgundy)	Bladder width = 6.7" (17cm) Bladder length = 15" (38cm) Limb circumference = 35-45cm Cuff length = 32.9" (83.5cm)	Pkg. wt. = 6.4oz (181.9g) Qty. = 1 cuff	
M4569B CE	Thigh (Grey)	Bladder width = 8.3" (21cm) Bladder length = 18.9" (48cm) Limb circumference = 44-56cm Cuff length = 33.1" (84cm)	Pkg. wt. = 7.3oz (206.8g) Qty. = 1 cuff	

* Accuracy is dependent on proper application according to cuff labeling



New Antimicrobial Coated NIBP Cuffs - Double Hose (Not Available in the U.S.)

Traditional Multi-Patient (Reusable) NIBP Cuffs

- Use appropriate NIBP tubing for specified monitors listed on page 6-17

Product Number	Size	Description	Packaging Information	Use with Philips Instrument
40401A CE	Infant size	Bladder width = 2.4" (6cm) Bladder length = 4.7" (12cm) Limb circumference = 10cm to 19cm	Pkg. wt. = 2oz (57g) Qty. = 1 cuff	78352A/C, 78354A/C, 862474, 862478 (C3) 863051 to 863054 (C1) 863055 to 863062 (VS1) M3921A to M3924A (A1) M3926A to M3929A (A3) M3535A, M3536A (HeartStart MRx) SureSigns VM4, VM6, VM8, VS3
40401B CE	Pediatric size	Bladder width = 3.5" (8.9cm) Bladder length = 7.1" (18cm) Limb circumference = 18cm to 26cm	Pkg. wt. = 3oz (85g) Qty. = 1 cuff	78352A/C, 78354A/C, 862474, 862478 (C3) 863051 to 863054 (C1) 863055 to 863062 (VS1) M3921A to M3924A (A1) M3926A to M3929A (A3) M3535A, M3536A (HeartStart MRx) M2636B/C (TeleMon B/C) SureSigns VM4, VM6, VM8, VS3
40401C CE	Adult size	Bladder width = 4.8" (12.1cm) Bladder length = 9.1" (23cm) Limb circumference = 25cm to 35cm	Pkg. wt. = 5oz (142g) Qty. = 1 cuff	78352A/C, 78354A/C, 862474, 862478 (C3) 863051 to 863054 (C1) 863055 to 863062 (VS1) M3921A to M3924A (A1) M3926A to M3929A (A3) M3535A, M3536A (HeartStart MRx) M2636B/C (TeleMon B/C) SureSigns VM4, VM6, VM8, VS3
40401D CE	Large adult size	Bladder width = 6" (15.2cm) Bladder length = 13" (33cm) Limb circumference = 33cm to 47cm	Pkg. wt. = 7oz (197g) Qty. = 1 cuff	78352A/C, 78354A/C, 862474, 862478 (C3) 863051 to 863054 (C1) 863055 to 863062 (VS1) M3921A to M3924A (A1) M3926A to M3929A (A3) M3535A, M3536A (HeartStart MRx) SureSigns VM4, VM6, VM8, VS3
40401E CE	Thigh size	Bladder width = 7" (17.8cm) Bladder length = 14.2" (36cm) Limb circumference = 46cm to 66cm	Pkg. wt. = 9oz (255g) Qty. = 1 cuff	78352A/C, 78354A/C, 862474, 862478 (C3) 863051 to 863054 (C1) 863055 to 863062 (VS1) M3921A to M3924A (A1) M3926A to M3929A (A3) M3535A, M3536A (HeartStart MRx) SureSigns VM4, VM6, VM8, VS3



40401A-E

Kits, Traditional Multi-Patient Cuffs

Product Number	Description	Packaging		Use with Philips Instrument
40400A CE	Kit containing pediatric, adult, and large adult size cuffs (40401B/C/D).	1 kit = 3 cuffs	Pkg. wt. = 1lb 3oz (539g)	78352A/C, 78354A/C, 862474, 862478 (C3) 863051 to 863054 (C1) 863055 to 863062 (VS1) M2636B/C (TeleMon B/C) M3921A to M3924A (A1) M3926A to M3929A (A3) M3535A, M3536A (HeartStart MRx) SureSigns VM4, VM6, VM8, VS3
40400B CE	Kit containing all 5 cuffs (40401A/B/C/D/E).	1 kit = 5 cuffs	Pkg. wt. = 2lb 2oz (964g)	78352A/C, 78354A/C, 862474, 862478 (C3) 863051 to 863054 (C1) 863055 to 863062 (VS1) M3921A to M3924A (A1) M3926A to M3929A (A3) M3535A, M3536A (HeartStart MRx) SureSigns VM4, VM6, VM8, VS3

Disposable NIBP Cuffs: Latex-Free

- Use appropriate NIBP tubing for specified monitors on page 6-17
- See “Philips NIBP Cuff Adapters” on page 6-19 for adaptability of cuffs to other manufacturers’ brand instruments.

Single Patient (Disposable) Cuffs

Product Number	Size	Description	Packaging Information	Use with Philips Instrument
M1874A CE	Infant size	Bladder width = 2.2” (5.5cm) Bladder length = 6.1” (15.4cm) Limb circumference = 10cm to 15cm	1 case= 2 boxes= 10 cuffs	Pkg. wt. = 14oz (397g) 78352A/C, 78354A/C 862474, 862478 (C3) 863055 to 863062 (VS1) M1008A/B Modules M3000A, M3001A, M3002A M8102A, M8105A (MP2, MP5)
M1875A CE	Pediatric size	Bladder width = 3.1”(8cm) Bladder length = 8.5”(21.5cm) Limb circumference = 14cm to 21.5cm		Pkg. wt. = 1lb 2oz (510g) 78352A/C, 78354A/C 862474, 862478 (C3) 863055 to 863062 (VS1) M1008A/B Modules M3000A, M3001A, M3002A M8102A, M8105A (MP2, MP5)
M1876A CE	Small adult size	Bladder width = 4.1” (10.5cm) Bladder length = 9.4” (24cm) Limb circumference = 20.5cm to 28cm		Pkg. wt. = 1lb 7oz (652g)
M1877A CE	Adult size	Bladder width = 5.1” (13cm) Bladder length = 11” (28cm) Limb circumference = 27cm to 35cm		Pkg. wt. = 2lb 4oz (1.02kg) 78352A/C, 78354A/C 862474, 862478 (C3) 863055 to 863062 (VS1) M1008A/B Modules M1350B/C Fetal Monitors M2702A, M2703A (Avalon) M3000A, M3001A, M3002A M8102A, M8105A (MP2, MP5)
M1878A CE	Large adult size	Bladder width = 6.3” (16cm) Bladder length = 13.8” (35cm) Limb circumference = (34cm to 43cm)		
M1879A CE	Thigh size	Bladder width = 7.9” (20cm) Bladder length = 16.9” (43cm) Limb circumference = (42cm to 54cm)		



M1874A, M1875A, M1876A, M1877A, M1878A

Soft Single-Patient (Disposable) Cuffs - Single Hose Model

- Use appropriate NIBP tubing for specified monitors listed on page 6-17

Product Number	Size (Print Color)	Description	Packaging Information	Use with Philips Instrument
M4572B CE	Infant (Orange)	Bladder width = 2.2" (5.5cm) Bladder length = 5.9" (15cm) Limb circumference = 10-15cm Cuff length: 8.7" (22cm)	Pkg. wt. = 11.1oz (315.2g) Qty. = 10 cuffs	78352A/C, 78354A/C 863051 to 863054 (C1) 862474, 862478 (C3) 863055 to 863062 (VS1) M1008A/B Modules M3000A, M3001A, M3002A M3535A, M3536A (HS MRx) M8102A, M8105A (MP2, MP5) SureSigns VM4, VM6, VM8, VS3
M4573B CE	Pediatric (Green)	Bladder width = 3.1" (8cm) Bladder length = 8.5" (21.5cm) Limb circumference = 14-21.5cm Cuff length: 12.2" (31cm)	Pkg. wt. = 13.5oz (383.3g) Qty. = 10 cuffs	78352A/C, 78354A/C 863051 to 863054 (C1) 862474, 862478 (C3) 863055 to 863062 (VS1) M1008A/B Modules M2636B/C TeleMon B/C M3000A, M3001A, M3002A M3535A, M3536A (HS MRx) M8102A, M8105A (MP2, MP5) SureSigns VM4, VM6, VM8, VS3
M4574B CE	Small Adult (Light Blue)	Bladder width = 4.2" (10.6cm) Bladder length = 9.4" (24cm) Limb circumference = 20.5- 28.5cm Cuff length: 16.5" (42cm)	Pkg. wt. = 1.1 lb. (496.7g) Qty. = 10 cuffs	
M4575B CE	Adult (Navy Blue)	Bladder width = 5.3" (13.5cm) Bladder length = 11.8" (30cm) Limb circumference = 27.5-36cm Cuff length = 20.7" (52.5cm)	Pkg. wt. = 1.7 lbs. (762g) Qty. = 10 cuffs	78352A/C, 78354A/C 863051 to 863054 (C1) 862474, 862478 (C3) 863055 to 863062 (VS1) M1008A/B Modules
M4576B CE	Adult Extra Long* (Navy Blue)	Bladder width = 5.3" (13.5cm) Bladder length = 11.8" (30cm) Limb circumference = 27.5-36cm Cuff length = 26" (66cm)	Pkg. wt. = 2 lbs. (920.8g) Qty. = 10 cuffs	M1350B/C Fetal Monitors M2702A, M2703A (Avalon) M2636B/C (TeleMon B/C) M3000A, M3001A, M3002A M3535A, M3536A (HS MRx) M8102A, M8105A (MP2, MP5) SureSigns VM4, VM6, VM8, VS3
M4577B CE	Large Adult (Burgundy)	Bladder width = 6.7" (17cm) Bladder length = 15" (38cm) Limb circumference = 35-45cm Cuff length = 26.2" (66.5cm)	Pkg. wt. = 2.2lbs. (1020.1g) Qty. = 10 cuffs	
M4578B CE	Large Adult Extra Long* (Burgundy)	Bladder width = 6.7" (17cm) Bladder length = 15" (38cm) Limb circumference = 35-45cm Cuff length = 32.9" (83.5cm)	Pkg. wt. = 2.7 lbs. (1246.9g) Qty. = 10 cuffs	
M4579B CE	Thigh (Grey)	Bladder width = 8.3" (21cm) Bladder length = 18.9" (48cm) Limb circumference = 44-56cm Cuff length = 33.1" (84cm)	Pkg. wt. = 3.2 lbs. (1473.7g) Qty. = 10 cuffs	78352A/C, 78354A/C 863051 to 863054 (C1) 862474, 862478 (C3) 863055 to 863062 (VS1) M1008A/B Modules M1350B/C Fetal Monitors M2702A, M2703A (Avalon) M3000A, M3001A, M3002A M3535A, M3536A (HS MRx) M8102A, M8105A (MP2, MP5) SureSigns VM4, VM6, VM8, VS3

*Accuracy is dependent on proper application according to cuff labeling.



Soft Single-Patient (Disposable) NIBP Cuffs - Single Hose (color coded sizes)

Soft Single-Patient (Disposable) Cuffs - Double Hose Models

- Use other manufacturers' NIBP tubing along with appropriate Philips adapter.

Product Number	Size (Print Color)	Description	Packaging Information	Use With Other Manufacturers' Instrument
M4582B CE	Infant (Orange)	Bladder width = 2.2" (5.5cm) Bladder length = 5.9" (15cm) Limb circumference = 10-15cm Cuff length: 8.7" (22cm)	Pkg. wt. = 14.8oz (419.6g) Qty. = 10 cuffs	For use with Double-Hose Monitors. See page 6-19 for adaptability of cuffs to Philips and additional manufacturers' brand instruments.
M4583B CE	Pediatric (Green)	Bladder width = 3.1" (8cm) Bladder length = 8.5" (21.5cm) Limb circumference = 14-21.5cm Cuff length: 12.2" (31cm)	Pkg. wt. = 1.1 lb. (487.6g) Qty. = 10 cuffs	
M4584B CE	Small Adult (Light Blue)	Bladder width = 4.2" (10.6cm) Bladder length = 9.4" (24cm) Limb circumference = 20.5-28.5cm Cuff length: 16.5" (42cm)	Pkg. wt. = 1.4 lbs. (623.7g) Qty. = 10 cuffs	
M4585B CE	Adult (Navy Blue)	Bladder width = 5.3" (13.5cm) Bladder length = 11.8" (30cm) Limb circumference = 27.5-36cm Cuff length: 20.7" (52.5cm)	Pkg. wt. = 1.9 lbs. (843.7g) Qty. = 10 cuffs	
M4586B CE	Adult Extra Long* (Navy Blue)	Bladder width = 5.3" (13.5cm) Bladder length = 11.8" (30cm) Limb circumference = 27.5-36cm Cuff length: 26" (66cm)	Pkg. wt. = 2.2 lbs. (1002.4g) Qty. = 10 cuffs	
M4587B CE	Large Adult (Burgundy)	Bladder width = 6.7" (17cm) Bladder length = 15" (38cm) Limb circumference = 35-45cm Cuff length: 26.2" (66.5cm)	Pkg. wt. = 2.4 lbs. (1101.8g) Qty. = 10 cuffs	
M4588B CE	Large Adult Extra Long* (Burgundy)	Bladder width = 6.7" (17cm) Bladder length = 15" (38cm) Limb circumference = 35-45cm Cuff length: 32.9" (83.5cm)	Pkg. wt. = 2.9 lbs. (1328.6g) Qty. = 10 cuffs	
M4589B CE	Thigh (Grey)	Bladder width = 8.3" (21cm) Bladder length = 18.9" (48cm) Limb circumference = 44-56cm Cuff length: 33.1" (84cm)	Pkg. wt. = 3.4lb (1555.4g) Qty. = 10 cuffs	

* accuracy is dependent on proper application according to cuff labeling.



Soft Single-Patient (Disposable) Cuffs - Double Hose (color coded sizes)

NIBP Interconnect Tubing

Adult/Pediatric Pressure Cuff Interconnect Tubing

Product Number	Description	Length	Qty/Bag	Use with Philips Instrument
M1598B CE	Connects all sizes of Philips' reusable and disposable adult and pediatric NIBP cuffs to the monitor. Use with adult and pediatric pressure cuffs only. <i>CANNOT BE USED WITH NEONATAL CUFFS.</i>	Length = 4.92' (1.5m)	1 bag= 1 tube	78352A/C, 78354A/C 862474, 862478 (C3) M2636A/B/C TeleMon M1008A/B Modules M1350B/C Fetal Monitors M2702A, M2703A (Avalon) SureSigns VM4, VM6, VM8, VS3 M3000A, M3001A, M3002A M3535A, M3536A (HeartStart MRx) M8102A, M8105A (MP2, MP5)
M1599B CE		Length = 9.84' (3.0m)		
M3918A CE	Adult/Pediatric NIBP hose for use with A1/A3/C1 monitors. Use with adult and pediatric pressure cuffs only. <i>CANNOT BE USED WITH NEONATAL CUFFS.</i>	Length = 10' (3.0m)		
9898031 36931 CE	Adult/Pediatric NIBP hose for use with VS1 monitors. Use with adult and pediatric pressure cuffs only. <i>CANNOT BE USED WITH NEONATAL CUFFS.</i>	Length = 11.71' (3.57m)		



M1599B



M3918A

NIBP Cuff Caps

Product Number	Description	Packaging Information
9898031 51601	Cuff Caps for Single Hose NIBP Cuffs	10 per bag
9898031 51611	Cuff Caps for Double Hose NIBP Cuffs	20 per bag



989803151601















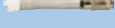

989803151611

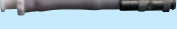
NIBP Cuff Adapters

NIBP Cuff Adapters

Philips offers a comprehensive system of adapters that allows you to develop a universal solution to connect Philips NIBP cuffs to other manufacturers' NIBP monitors. Find the brand and model of your NIBP monitoring systems to see which Philips cuffs and adapters are a perfect fit for your needs. Adapters are semi-permanently fastened to the monitor air hose-end, eliminating loss or confusion.

Using this brand of single-hose monitor	The monitor hose end looks like this	Select this adapter	To connect to these Philips NIBP Cuffs (excluding neonatal sizes)
Most models with threaded female style connector: <ul style="list-style-type: none"> • Welch-Allyn 		M4550A 1-hose adapter  M4551A 2-hose Y adapter 	All 1-hose Philips reusable & disposable cuff models, excluding 40401x series 2-hose reusable cuff models (M456xA/B series) and soft single-patient disposable models (M458xA/B series only)
Most models with female quick-connect style connector:		M4560A 1-hose adapter  M4561A 2-hose Y adapter 	All 1-hose Philips reusable & disposable cuff models, excluding 40401x series 2-hose reusable cuff models (M456xA/B series) and soft single-patient disposable models (M458xA/B series only)
Most models with female locking luer-style connector: <ul style="list-style-type: none"> • Draeger 		M4570A 1-hose adapter  M4571A 2-hose Y adapter 	All 1-hose Philips reusable & disposable cuff models, excluding 40401x series 2-hose reusable cuff models (M456xA/B series) and soft single-patient disposable models (M458xA/B series only)
Most models with locking luer-style connector: <ul style="list-style-type: none"> • Colin • Datascope-Passport • Spacelabs • Welch-Allyn • Mindray 		M4590A 1-hose adapter  M4595A 2-hose Y adapter 	All 1-hose Philips reusable & disposable cuff models, excluding 40401x series 2-hose reusable cuff models (M456xA/B series) and soft single-patient disposable models (M458xA/B series only)
Most models with male quick-connect style connector: <ul style="list-style-type: none"> • Welch-Allyn Protocol (formerly Protocol Systems) 		M4591A 1-hose adapter  M4596A 2-hose Y adapter 	All 1-hose Philips reusable & disposable cuff models, excluding 40401x series 2-hose reusable cuff models (M456xA/B series) and soft single-patient disposable models (M458xA/B series only)
Most models with bayonet-style connector: <ul style="list-style-type: none"> • Spacelabs • Siemens • Mindray 		No adapter needed for 1-hose M4594A 2-hose Y adapter 	All 1-hose Philips reusable & disposable cuff models, excluding 40401x series 2-hose reusable cuff models (M456xA/B series) and soft single-patient disposable models (M458xA/B series only)

Using this brand of double-hose monitor	The monitor hose end looks like this	Select this adapter	To connect to these Philips 2-hose NIBP Cuffs
Most models with male quick-connect style connector • GE (Marquette)		M4592A 2-hose adapter 	2-hose reusable cuff models (M456xA/B series) and soft single-patient disposable models (M458xA/B series only)
Most models with one male and one female quick-connect style connector: • Datex/Ohmeda		M4593A 2-hose adapter 	2-hose reusable cuff models (M456xA/B series) and soft single-patient disposable models (M458xA/B series only)
Most models with thread-type Critikon style connector: • GE (Critikon) • Welch-Allyn		No adapter needed	2-hose reusable cuff models (M456xA/B series) and soft single-patient disposable models (M458xA/B series only)

How they are connected:

1. Attach the silver connector of the adapter to the NIBP Cuff and the white connector to the monitoring hose end.
2. For 1-hose cuff adapter applications, the silver connector is a female bayonet style.
3. For 2-hose and Y adapter applications, the silver connectors are thread-type connectors.
4. The adapters are fastened to the monitoring hose with a plastic tie-wrap to prevent loss.

Bulb and valve kit for manual sphygmomanometer

To connect to a manual sphygmomanometer, select this kit	To connect to these 2-hose Philips NIBP Cuffs
Bulb and Valve Kit M4580A (for a secure fit to Philips cuffs)	
	2-hose reusable cuff models (M456xA/B) series and soft single-patient disposable models (M458xA/B series only)

If your original tubing looks like this:



Follow these simple steps:



Remove connector from your existing coiled tubing.



Insert new connector included in your kit.



Connect your coiled tubing to your Philips double-hose cuff.

To replace your coiled tubing, select:

To replace your coiled tubing, select:	
Replacement coiled tubing: M4581A	

Neonatal NIBP Cuffs: Latex Free

- Use appropriate NIBP tubing for specified monitors listed on page 6-19

Single-Patient (Disposable) Cuffs, Non-Sterile

Product Number	Size	Description	Packaging Information	Use with Philips Instrument
M1866A CE	Size 1	Bladder width = 1" (2.5cm) Bladder length = 2.5" (6.4cm) Limb circumference = 3.1cm to 5.7cm	1 case = 2 boxes = 20 cuffs	78834C 78352A/C 78354A/C M1008A/B M3000A M3001A M3002A M8102A M8105A
M1868A CE	Size 2	Bladder width = 1.3" (3.2cm) Bladder length = 2.9" (7.3cm) Limb circumference = 4.3cm to 8cm		
M1870A CE	Size 3	Bladder width = 1.7" (4.2cm) Bladder length = 3.9" (10cm) Limb circumference = 5.8cm to 10.9cm		Pkg. wt. = 11oz (312g)
M1872A CE	Size 4	Bladder width = 2" (5.1cm) Bladder length = 4.7" (11.9cm) Limb circumference = (7.1cm to 13.1cm)		Pkg. wt. = 14oz (397g)



M1866A, M1868A, M1870A, M1872A

Neonatal Interconnect Tubing

Neonatal Pressure Cuff Interconnect Tubing

Product Number	Description	Length	Qty/Bag	Use with Philips Instrument
M1596B CE	Connects all sizes of Philips' disposable neonatal NIBP cuffs to the monitor. Use with neonatal pressure cuffs only. <i>CANNOT BE USED WITH ADULT/ PEDIATRIC CUFFS.</i>	Length = 4.92' (1.5m)	1 bag = 1 tube	78834C 78352A/C 78354A/C M1008A/B M3000A M3001A M3002A M8102A M8105A SureSigns VM4, VM6, VM8 and VS3
M1597B CE		Length = 9.84' (3.0m)		
9898031 36941 CE	Neonatal NIBP hose for use with VS1 monitors. Use with neonatal pressure cuffs only. <i>CANNOT BE USED WITH ADULT/ PEDIATRIC CUFFS.</i>	Length = 11.71' (3.57m)		All VS1 Monitors: 863055, 863056, 863057, 863058, 863059, 863060, 863061, 863062



M1597B

Notes

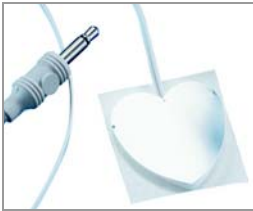

Chapter 7

Temperature Probes

For Information About	See Page
Disposable Temperature Probes-Continuous Monitoring (Latex-Free)	7-2
Reusable Temperature Probes-Continuous Monitoring (Latex-Free)	7-6
Predictive Temperature Monitoring	7-7

Products labeled with a CE mark indicates compliance with the EU Medical Devices Directive.

Disposable Temperature Probes-Continuous Monitoring (Latex-Free)

Disposable Esophageal/Rectal Temperature Probes (meets EN12470 Standard)

Product Number	Description	Packaging Information			Use with Philips Instrument	
M1837A CE	Sterilized	9 FR probe Length=36" (91cm)	1 box= 20 probes	Pkg. wt. = 1 lb (454g)	Shelf life: At least 12 months	Philips temperature monitors including: 862474, 862478 (C3) 863064, 863065, (VM6) 863066, 863068 (VM8) M8102A (MP2) M3002A (MMS X2) M3535A/M3536A with Option A06 (HeartStart MRx Defibrillator/Monitor)
21090A CE		12 FR probe Length=36" (91cm)				Pkg. wt. = 1 lb 2oz (510g)
						Philips temperature monitors including: 862474, 862478 (C3) M8102A (MP2) M3002A (MMS X2) M3535A/M3536A with Option A06 Excluding: A1/A3/C1/VS1/VS3/VM4/ VM6/VM8

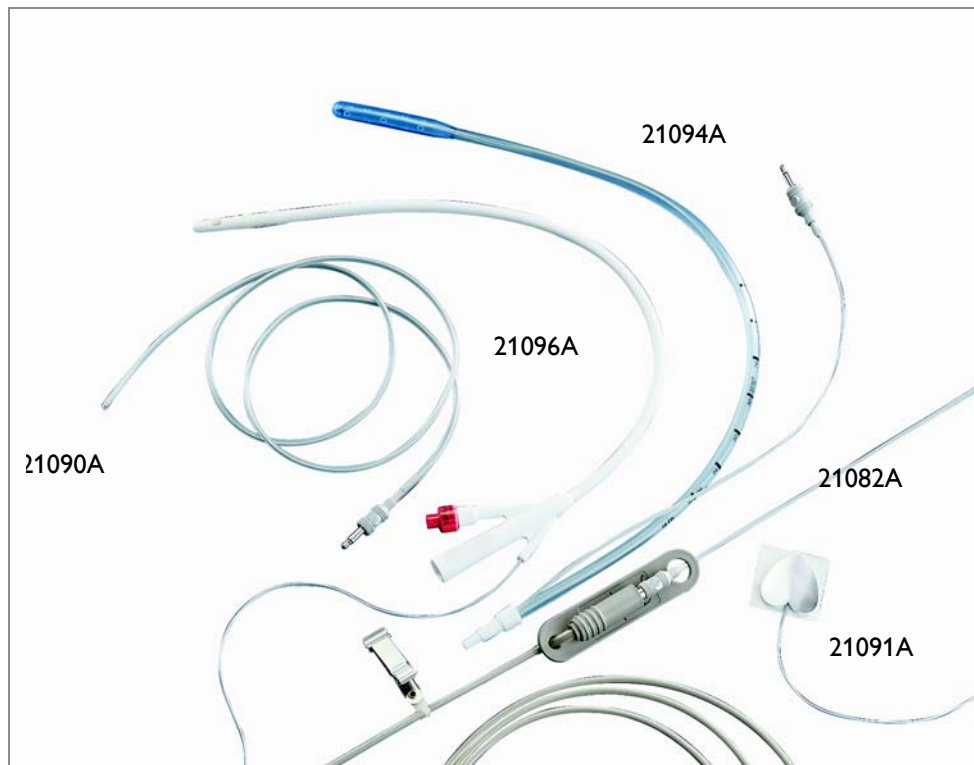

Disposable Esophageal Stethoscope Temperature Probes (meets EN12470 Standard)

Product Number	Description	Packaging Information			Use with Philips Instrument	
21093A CE	Sterilized	12 FR probe Length = 18" (45cm)	1 box = 20 probes Shelf life: At least 12 months	Pkg. wt. = 1lb 3oz (539g)	Philips temperature monitors including: 863064, 863065, (VM6) 863066, 863068 (VM8) M8102A (MP2) M3002A (MMS X2) M3535A/M3536A with Option A06 Excluding: A1/A3/C1/C3/VS1/VS3/VM4	
21094A CE photo next page		18 FR probe Length = 18" (45cm)			Pkg. wt. = 1lb 6oz (624g)	Philips temperature monitors including: M8102A (MP2) M3002A (MMS X2) M3535A/M3536A with Option A06 (HeartStart MRx)
21095A CE		24 FR probe Length = 18" (45cm) Not available in Japan			Pkg. wt. = 1lb 11oz (765g)	Excluding: A1/A3/C1/C3/VS1/VS3/ VM4/VM6/VM8

Disposable Skin Surface Temperature Probes

Product Number	Description	Packaging Information			Use with Philips Instrument	
21091A CE photo next page	Sterilized.	Length = 28" (71cm)	1 box = 20 probes	Pkg. wt. = 13oz (369g)	Shelf life: At least 12 months	Philips temperature monitors including: 862474, 862478 (C3) 863064, 863065, (VM6) 863066, 863068 (VM8) M8102A (MP2) M3002A (MMS X2) M3535A/M3536A with Option A06 Excluding: A1/A3/C1/VS1/VS3/VM4

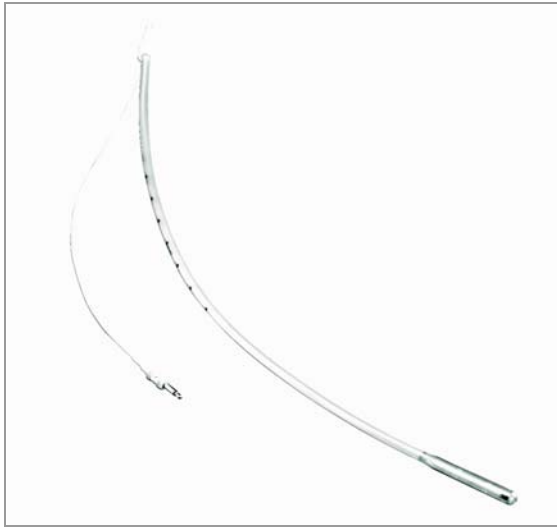

21094A

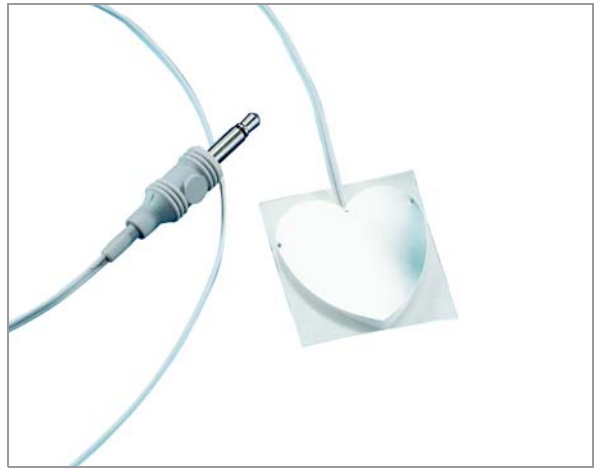

21091A

Disposable Foley Catheter Temperature Probes (meets EN12470 Standard)

Product Number	Description	Packaging Information			Use with Philips Instrument
M2255A CE	Sterilized	14 FR probe Length = 17" (43cm)	1 box = 10 probes	Pkg. wt. = 3 lb (1.5kg)	Philips temperature monitors including: M8102A (MP2) M3002A (MMS X2) M3535A/M3536A with Option A06 Excluding: A1/A3/C1/C3/VS1/VS3/ VM4/VM6/VM8
21096A CE		16 FR probe Length = 17" (43cm)		Pkg. wt. = 1 lb 1oz (482g)	
21097A CE		18 FR probe Length = 17" (43cm)		Pkg. wt. = 1 lb 4oz (567g)	

Temperature Probes Extension Cables for Disposable Probes (meets EN12470 Standard)

Product Number	Description	Packaging Information			Use with Philips Instrument
21082A CE	2-pin plug extension cable, accepts mini (1/8") phone plug. Terminates in 2-prong plug.	Length = 10' (3m)	1 pack = 1 cable	Pkg. wt. = 3oz (85g)	All Philips temperature monitors that accept two-prong plugs
21082B CE		Length = 5' (1.5m)		Pkg. wt. = 2oz (57g)	

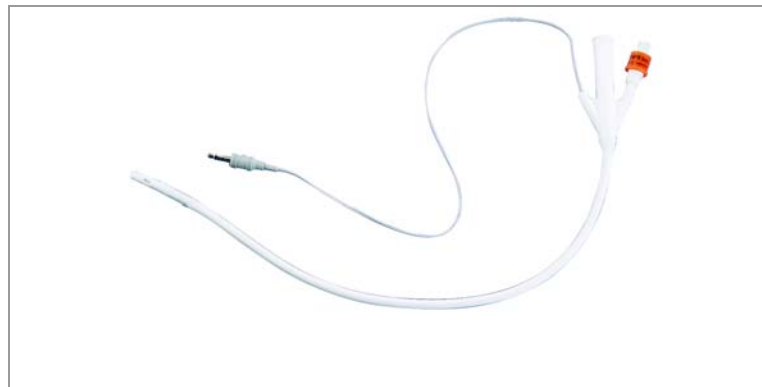

21096A



21082A

Reusable Temperature Probes-Continuous Monitoring (Latex-Free)

Reusable Temperature Probes with 2-Prong Plug (meets EN12470 Standard)

Product Number	Description	Packaging Information		Use with Philips Instrument
21075A CE	Esophageal/rectal temperature probe.	12 Fr probe Lead length = 10' (305cm) Typical time constant = 7 seconds	1 box = 1 probe	Pkg. wt. = 4oz (113g) All Philips temperature monitors including: 862474, 862478 (C3) 863064, 863065, (VM6) 863066, 863068 (VM8) M8102A (MP2) M3002A (MMS X2) M3535A/M3536A with Option A06 Excluding: A1/A3/C1/VS1/VS3/VM4
21076A CE	Small flexible infant esophageal/rectal probe with vinyl sheath and tip.	10 Fr probe Lead length = 10' (305cm) Typical time constant = 3.2 seconds		
21078A CE	Reusable tape-on surface temperature probe. Stainless steel disc, epoxy backed.	0.37" (9.5mm) diameter Lead length=10' (305cm) Typical time constant= 1.1 seconds		

Reusable Temperature Probes for A3 Series Monitors

Product Number	Description	Packaging Information		Use with Philips Instrument
M3916A CE	Reusable skin probe.	1 box = 1 probe	Pkg. wt. = 2oz (57g)	M3926A M3927A M3928A M3929A
M3917A CE	Esophageal/rectal probe.		Pkg. wt. = 4oz (113g)	



21078A



M3916A

Predictive Temperature Monitoring

Reusable Temperature Probes for A1 and C1 Series Monitors

Product Number	Description	Packaging Information		Use with Philips Instrument
M4821A CE	Reusable Oral temperature probe	1 box = 1 probe	Pkg. wt. = 2.6oz (73.7g)	M3922A (A1) M3924A (A1) 863052 (C1) 863054 (C1)
M4822A CE	Reusable Rectal temperature probe		Pkg. wt. = 4oz (113g)	
M4823A CE	Disposable Temp probe covers	1,000/case	Pkg. wt. = 2.3lb (1.04kg)	

Reusable Temperature Probes for VS1 Monitor

Product Number	Description	Packaging Information		Use with Philips Instrument
9898031 36901 CE	Reusable Oral temperature probe	1 box = 1 probe	Pkg. wt. = 1.5oz (40g)	863056, 863058, 863062, 863060
9898031 36911 CE	Reusable Rectal temperature probe		Pkg. wt. = 1.5oz (40g)	
9898031 36921 CE	Disposable Temp probe covers	200/case	Pkg. wt. = 9oz (260g)	

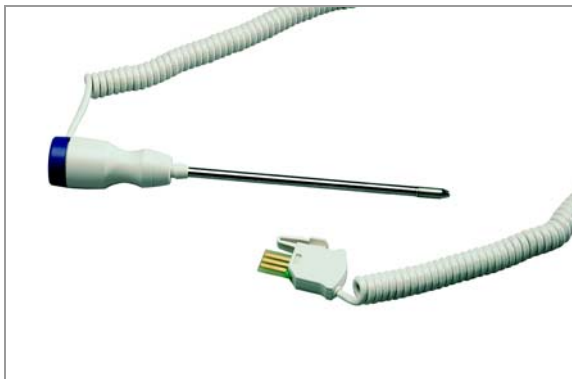

M4821A



M4822A



989803136901 with cover



989803136911 with cover

Reusable Temperature Probes for SureSigns VM4 and VS3

Product Number	Description	Packaging Information		Use with Philips Instrument
9898031 43381 CE	Reusable Oral temperature probe Length: 9 ft. (2.7m)	1 box = 1 probe	Pkg. wt. = 4.23oz (0.12kg)	863063 (VM4) 863070 (VS3) 863071 (VS3) M8105A (MP5)
989803143391 CE	Reusable Rectal temperature probe Length: 9 ft. (2.7m)			
M4823A CE	Disposable Temp Probe Covers	1,000/case	Pkg. wt. = 2.2 lbs (1kg)	



9898031 43381 (Probe and Well Kit)

Notes



Chapter 8

Gas Monitoring Supplies

For Information About	See Page
Transcutaneous Gas Monitoring Supplies	8-2
Mainstream CO ₂	8-3
Sidestream CO ₂ Monitoring Supplies	8-4
Spirometry CO ₂ /Flow	8-9
Anesthetic Gas Supplies	8-10
Bispectral Index™ (BIS) Sensors	8-12

Products labeled with a CE mark indicates compliance with the EU Medical Devices Directive.

Transcutaneous Gas Monitoring Supplies

TcPO₂/CO₂ Monitoring Supplies

Product Number	Description	Packaging Information			Use with Philips Instrument
15209–60010 CE	Accessory kit for 15209A and M1918A transducer. Includes 10ml electrolyte, 12 membranes, O-ring remover, 25 cleaning papers, 2 transducer caps, and instructions.	1 box = 1 kit	Pkg. wt. = 5oz (142g)	Shelf life: At least 12 months	N/A
15209–60020 CE	Fixation kit for 15207A, 15209A and M1918A transducer. Includes 100 fixation rings, 4 (20ml) bottles contact liquid, and instructions.		Pkg. wt. = 9oz (255g)	Shelf life: At least 6 months	
15210–60010	CAL 1 gas cylinders for calibrating 15205A, 15206A, 15209A and M1918A transducers. Not available in Europe or Japan.	1 box = 6 cylinders	Pkg. wt. = 6 lb 14oz (3.12kg)	Shelf life: At least 12 months	15210A 15210AH 15210B Calibration unit
15210–60020	CAL 2 gas cylinders for calibrating 15205A, 15206A, 15209A transducers. Not available in Europe or Japan.	1 box = 6 cylinders	Pkg. wt. = 7 lb (3.18kg)	Shelf life: At least 12 months	15210A 15210AH 15210B Calibration unit
15210–64010	CAL 1 gas cylinders for calibrating 15205A, 15206A, 15209A and M1918A transducers. Meets international shipping requirements.		Pkg. wt. = 6 lb 15oz (3.15kg)		15210A 15210AH 15210B Calibration unit
15210–64020	CAL 2 gas cylinders for calibrating 15205A, 15206A, 15209A and M1918A transducers. Meets international shipping requirements.		Pkg. wt. = 7 lb 1oz (3.2kg)		15210A 15210AH 15210B Calibration unit
M1918A CE	Solid state TcPO ₂ /CO ₂ transducer.	1 box = 1 transducer	Pkg. wt. = 6oz (170g)		M1018A M1205A
M2205A	Calibration tubes used to connect 15210B Calibration Unit to M1918A transducer during calibration.	1 box = 5 tubes	Pkg wt=1oz (28g)		15210B M1018A



M1918A

Mainstream CO₂Mainstream CO₂ Monitoring Supplies

Product Number	Description	Packaging		Use with Philips Instrument
M1460A CE	CO ₂ sensor for use with M1465A or 14363A airway adapters.	1 pack = 1 sensor	Pkg. wt. = 1 lb (454g)	47210A, 78345A, 78354A/C, 78356A, 78556A, 77834C, M1015A, M1016A, M3016A
14363A CE	Reusable pediatric airway adapter. 2cc of dead space, non-sterile. For patients weighing less than 10kg. Use M1460A CO ₂ sensors.	1 pack = 1 adapter	Pkg. wt. = 4oz (113g)	47210A, 78345A, 78354A/C, 78356A, 78556A, M1015A, M1016A M3016A
M1465A CE	Reusable standard airway adapter. 7.5cc dead space, non-sterile. For patients weighing 10kg or more. Use with M1460A CO ₂ sensors.		Pkg. wt. = 2.3oz (66g)	
M1614A	Cable Ties	5 ties = 1 bag	Pkg. wt. = 2.5oz (70g)	M1460A
M2501A CE	Mainstream CO ₂ Sensor	1 box = 1 sensor	Pkg. wt. = 11.2oz (317.5g)	IntelliVue M3014A EtCO ₂ Extension, M8102A MP2 M8105A MP5 M3002A MMS X2
M2513A CE	Reusable airway adapter (adult/pediatric), color: black. Endotracheal tube > 4mm.	1 box = 1 adapter	Pkg. wt. = 0.8oz (22.7 g)	M2501A Mainstream CO ₂ Sensor
M2516A CE	Reusable airway adapter (infant), color: red. Endotracheal tube ≤ 4mm.			
M2533A CE	Single patient disposable airway adapter (adult), color: clear. Endotracheal tube > 4mm.	1 box = 10 adapters	Pkg. wt. = 5.6oz (158.8 g)	
M2536A CE	Single patient disposable airway adapter (infant), color: violet. Endotracheal tube ≤ 4mm.			
M2505A	Gas regulator for the M2506A verification gas	1	Pkg. wt. = 8oz (226.8 g)	
M2506A	Verification gas for the M2501A sensor	1	Pkg. wt. = 1 lb (454 g)	



M1460A sensor with M1465A airway adapter

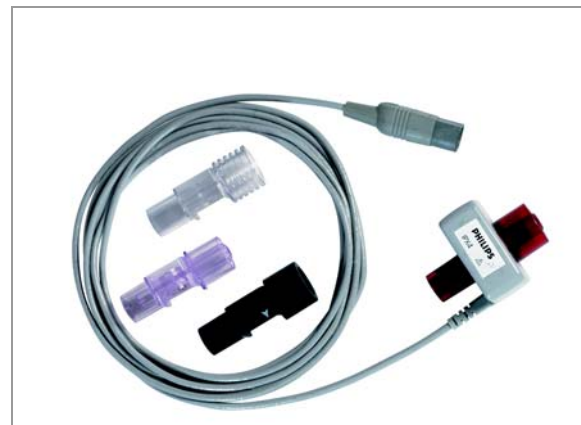

M2501A with disposable and reusable airway adapters

Sidestream CO₂ Monitoring Supplies

IntelliVue Sidestream CO₂ Monitoring Supplies

Product Number	Description		Packaging Information	Use with Philips Instrument
M2741A CE	Sidestream CO ₂ Sensor compatible with entire family of IntelliVue monitors (Release D.0 or later)		1 sensor	Pkg. wt. = 1.5 lbs (0.692kg) M3014A Extension Server M8102A MP2 M8105A MP5 M3002A MMS X2
M2744A CE	Disposable CO ₂ Nasal Cannula, adult	Non-Intubated	Box of 10	Pkg. wt. = 11.3 oz (.32kg)
M2745A CE	Disposable CO ₂ Nasal Cannula, pediatric			Pkg. wt. = 12 oz (.34kg)
M2746A CE	Disposable CO ₂ Nasal Cannula, infant			Pkg. wt. = 11.3 oz (.32kg)
M2750A CE	Disposable CO ₂ /O ₂ Nasal Cannula, adult			Pkg. wt. = 2 lbs (.88kg)
M2751A CE	Disposable CO ₂ /O ₂ Nasal Cannula, pediatric			
M2756A CE	Disposable CO ₂ Oral-Nasal Cannula, adult			Pkg. wt. = 12 oz (.34kg)
M2757A CE	Disposable CO ₂ Oral-Nasal Cannula, pediatric			
M2760A CE	CO ₂ /O ₂ Oral-Nasal Cannula, adult			
M2761A CE	CO ₂ /O ₂ Oral-Nasal Cannula, pediatric			Pkg. wt. = 2 lbs (.88kg)
M2768A CE	Airway Adapter Set (ET tube: greater than 4.0mm). Patient non-humidified.	Intubated		Pkg. wt. = 11.3 oz (.32kg)
M2772A CE	Airway Adapter Set H (ET tube: greater than 4.0mm). Patient humidified			
M2773A CE	Airway Adapter Set H (ET tube: equal to or less than 4.0mm). Patient humidified			
M2776A CE	Straight Sample Line (non-humidified)			
M2777A CE	Straight Sample Line H (humidified)			

M2741A Sidestream CO₂ Sensor and Accessories



M2768A
(airway adapter
short term)



M2773A
(airway adapter
long term)



M2750A CO₂/O₂ Nasal Cannula (non-intubated)



M2760A CO₂/O₂ Oral Nasal Cannula (non-intubated)



M2744A CO₂ Nasal Cannula (non-intubated)



M2756A CO₂ Oral-Nasal Cannula (non-intubated)

Sidestream CO₂ Monitoring Supplies (continued)

Product Number	Description	Packaging		Use with Philips Instrument
13901A CE	Reusable Nafion sample tube. Length= 8' (2.4m).	1 pack = 1 tube	Pkg. wt. = 1oz (28g)	M1015A M1016A
13902A CE	Disposable elbow airway adapter for single patient use.	1 pack = 20 adapters	Pkg. wt. = 5oz (142g)	
13904A CE	Disposable bacteria filter (0.45 micron) for single patient use.	1 pack = 20 filters	Pkg. wt. = 1oz (28g)	M1015A
13905A CE	Disposable Hybrid Nafion/polyethylene sample tube. Nafion Length = 6" (15cm). (Polyethylene) Length = 9' (270cm).	1 pack = 1 tube		
M1612A CE	Straight airway adapter for single patient use.	1 pack = 20 adapters	Pkg. wt. = 5oz (142g)	M1015A



13901A



13902A

Microstream® CO₂ Monitoring Supplies

Product Number	Description		Packaging Information	Use with Philips Instrument					
M1920A CE	Adult/pediatric FilterLine set, non-humidified (up to 6 hours). Photo next page.	Intubated	Pkg. wt. = 20oz (650g)	M3015A Microstream Extension Server C3 Monitor 862478					
M1921A CE	Adult/pediatric FilterLine H set, humidified (up to 72 hours).		Pkg. wt. = 24oz (680g)						
M1923A CE	Infant/neonatal FilterLine H set (yellow), humidified & non-humidified (up to 72 hours). Photo next page.		Pkg. wt. = 17.6oz (500g)						
M2520A CE	Pediatric Smart CapnoLine O ₂ , oral-nasal (up to 8 hours).	Non-Intubated Dual Purpose	Pkg. wt. = 24oz (680g)	HeartStart MRx M3535A/ M3536A Opt. A06					
M2522A CE	Adult Smart CapnoLine Plus O ₂ , oral-nasal (up to 8 hours). Photo next page.								
M2524A CE	Pediatric Smart CapnoLine, oral-nasal (up to 8 hours).	Non-Intubated Single Purpose	1 case= 25 sets	SureSigns VM8 Monitor 863066					
M2526A CE	Adult Smart CapnoLine Plus, oral-nasal (up to 8 hours).								
M4680A CE	Adult CapnoLine H O ₂ , nasal (up to 24 hours). Photo next page.	Non-Intubated Dual Purpose		Pkg. wt. = 32oz (900g)	M3015A Microstream Extension Server C3 Monitor 862478				
M4681A CE	Pediatric CapnoLine H O ₂ , nasal (up to 24 hours).								
M4686A CE	Adult NIV Line, nasal (up to 8 hours). Photo next page.	Mask, Single Purpose				Pkg. wt. = 32oz (900g)	M3015A Microstream Extension Server C3 Monitor 862478		
M4687A CE	Pediatric NIV Line, nasal (up to 8 hours).								
M4689A CE	Adult CapnoLine H, nasal (up to 24 hours). Photo next page.	Non-Intubated Single Purpose						Pkg. wt. = 32oz (900g)	HeartStart MRx M3535A/ M3536A Opt. A06
M4690A CE	Pediatric CapnoLine H, nasal (up to 24 hours).								
M4691A CE	Infant/neonatal CapnoLine H, nasal (up to 24 hours).								
M2267A	Calibration regulator. Constant flow rate of 180ml/min.	1							10.6oz (0.30kg)

Microstream FilterLines

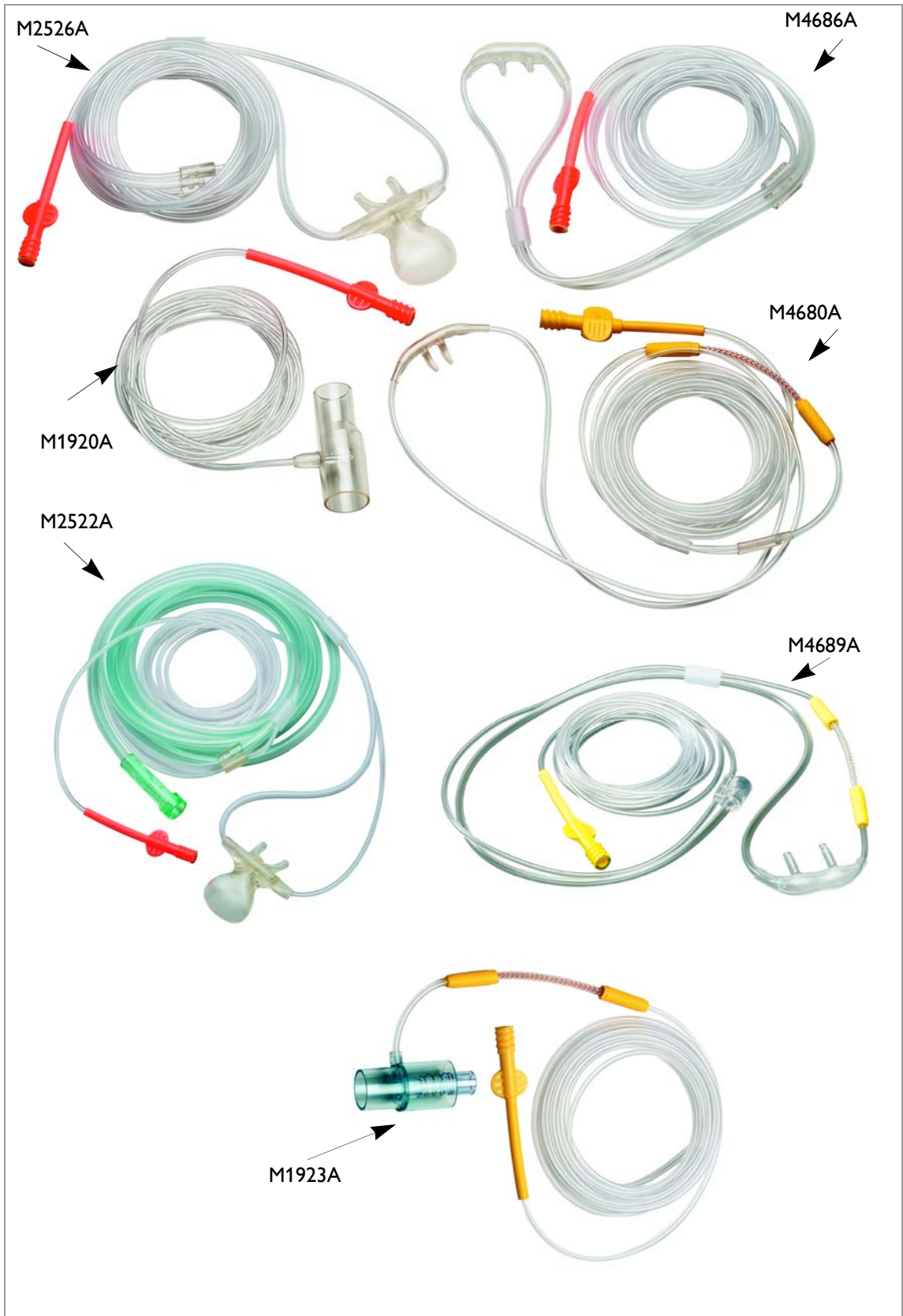

Spirometry CO₂/Flow

Flow Sensors and Combined CO₂/Flow Sensors

Product Number	Description	Packaging Information		Use with Philips Instrument
M2781A CE	Combined CO ₂ /Flow sensor, adult/pediatric ET: >5.5mm (color clear)	10 per box	2 lbs (.88kg)	M2501A Mainstream CO ₂ Sensor with M3014A Capnography Extension plus the M1014A Spirometry Module
M2782A CE	Combined CO ₂ /Flow sensor, infant/neonatal ET: 2.5-4mm (color: violet)			
M2783A CE	Combined CO ₂ /Flow Sensor, pediatric ET: 3.5-6mm (color green)			
M2785A CE	Flow Sensor, adult/pediatric ET: >4mm (color: clear)	1.7 lbs (.78kg)		M1014A Spirometry Module
M2786A CE	Flow Sensor, infant/neonatal ET: ≤ 4mm (color: violet)			

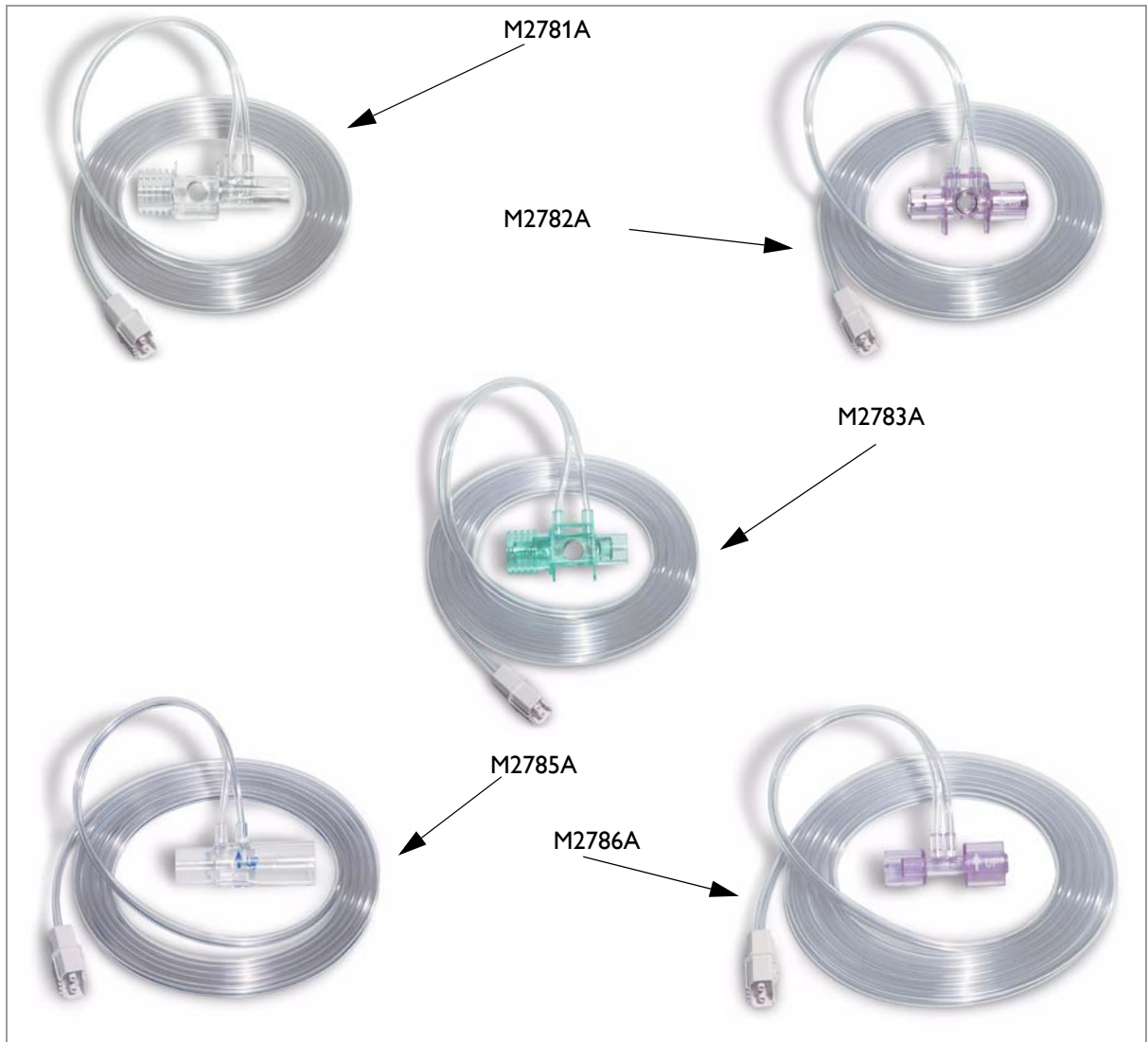

Anesthetic Gas Supplies

Anesthetic Gas Monitoring

Product Number	Description	Packaging		Use with Philips Instrument
13901A CE	Reusable Nafion sample tube. Length=8' (2.4m).	1 pack = 1 tube	Pkg. wt. = 1oz (28g)	
13905A CE	Disposable Hybrid Nafion/polyethylene sample tube. Nafion Length=6" (15cm). Polyethylene Length=9' (270cm).	1 pack = 1 tube	Pkg. wt. = 1oz (28g)	M1025A/B M1026A Opt. A01
13904A CE	Disposable bacteria filter (0.45 micron) for single patient use.	1 pack = 20 filters		
13902A CE	Disposable elbow airway adapter, for single patient use.	1 pack = 20 adapters	Pkg. wt. = 5oz (142g)	M1013A M1025A/B M1026A/B
M1612A CE	Straight airway adapter for single patient use.	1 pack = 20 adapters	Pkg. wt. = 5oz (142g)	
13906A	Calibration gas.	1 pack =1 cylinder	Pkg. wt. = 1lb 9oz (709g) Shelf life: At least 3 months	M1025A/B
13907A	Calibration tube assembly.	1 pack =1 assembly	Pkg. wt. = 1oz (28g)	M1025A/B M1026A/B



13901A



13902A

Anesthetic Gas Monitoring (continued)

Product Number	Description	Packaging		Use with Philips Instrument
M1655A CE	Reusable gas exhaust return line. Length: 12 ft. (3.6m) Not available in the U.S.	1 pack = 1 line and 5 filters	Pkg. wt. = 12oz (0.35kg)	M1026A
M1655B CE	Reusable gas exhaust return line. Length: 12 ft (3.6m)	1 pack = 1 line and 5 filters	Pkg. wt. = 9oz (0.25kg)	M1013A (G1) M1019A (G5) M1026B (not in USA)
M1656B CE	Disposable gas exhaust return filter. Use with M1655B.	1 pack = 20 filters	Pkg. wt. = 12oz (0.35kg)	M1013A (G1) M1019A (G5) M1026A M1026B (not in USA)
M1657B CE	Water trap. Use with M1658A	1 box = 25 traps	Pkg. wt. = 1 lb (454g)	M1013A (G1) M1019A (G5) M1026B M1026A with Opt A02/A05
M1658A CE	Gas sample tubing. Single patient use. Use with M1657B.	1 box = 20 tubes	Pkg. wt. = 12.4oz (351.5g)	M1013A (G1) M1019A (G5) M1026B M1026A with Opt A02/A05
M1659A	Calibration bag. Use with M1660A and M1662A.	1 bag	Pkg. wt. = 2oz (56.7g)	M1026A
M1660A	Calibration gas cylinder. Volume of gas equals 12 liters. Shelf life = 1 year. Use with M1659A.	1 cylinder	Pkg. wt. = 11.3oz (320g)	
M1662A	Anesthetic CAL Gas. Volume of gas equals 5 liters. Shelf life = 1 year. Use with M1659A.	1 cylinder	Pkg. wt. = 1.5 lb(0.7kg)	M1013A (G1) M1019A (G5) M1026B



M1657B

Bispectral Index™ (BIS) Sensors

Bispectral Index™ (BIS)

Philips Order Number	Description	Packaging	Use with Philips Instrument
M1997A CE	Aspect BIS Sensor Quatro Not available from Philips in U.S. or Japan. In North America contact Aspect Medical Systems.	1 case = 2 Boxes, 25/Box Shelf Life: 6 months	M1034A, M1034AX Module
M1998A CE	Aspect BIS Sensor Pediatric Not available from Philips in U.S. or Japan. In North America contact Aspect Medical Systems.	1 case = 1 Box, 25/Box Shelf Life: 6 months	M1034A, M1034AX Module
9898031 43581 CE	BIS Sensor Pediatric (4 electrodes) Not available from Philips in U.S. or Japan. In North America contact Aspect Medical Systems.	1 case = 1 box of 100 electrode sets and 1 semi-reusable cable. Shelf life: 6 months	M1034AX Module (Supported with IntelliVue C.0 or higher)
M4615A CE photo next page	BIS SRS Sensor: Includes 100 electrode sets and 1 semi-reusable cable. Not available from Philips in U.S. or Japan. In North America contact Aspect Medical Systems.	1	M4615A

M1997A



M1998A

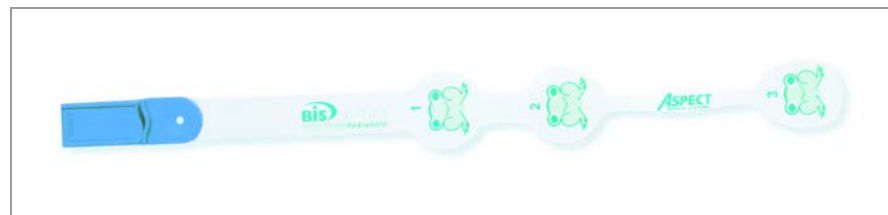

9898031 43851

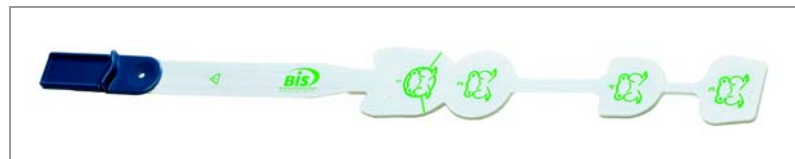



M4615A

Notes



Chapter 9

SpO₂ Monitoring

For Information About	See Page
Reusable SpO ₂ Sensors and Accessories	9-2
Disposable SpO ₂ Sensors and Accessories	9-7

Products labeled with a CE mark indicates compliance with the EU Medical Devices Directive.

Reusable SpO₂ Sensors and Accessories

Philips Reusable SpO₂ Sensors with 8-pin connector

Product No.	Description	Packaging Information	Philips Instrument
M1191A M1191B CEI	Reusable Adult finger SpO ₂ sensor. Length = 79" (2m) Patient Size: >50kg (>110 lb)	Pkg. wt. = 4oz (113g) Qty: 1 sensor	Refer to chart on page 9-12 and 9-13 for instrument compatibility.
M1191AL M1191BL CEI	Reusable Adult finger SpO ₂ sensor Length= 118" (3m) Patient Size: >50kg (>110 lb)	Pkg. wt. = 4.4oz (125g) Qty: 1 sensor	
M1192A CEI	Reusable Pediatric finger SpO ₂ sensor. Length = 59" (1.5m) Patient Size: 15-50kg (33-110 lb)	Pkg. wt. = 3oz (85g) Qty: 1 sensor	
M1193A CEI	Reusable Neonatal foot/hand SpO ₂ sensor. Length = 59" (1.5m) Patient Size: 1-4kg (2.2-8.8 lb)	Pkg. wt. = 3oz (85g) Qty: 1 sensor	
M1194A CEI	Reusable Pediatric/Adult ear clip SpO ₂ sensor. Preferred site: ear Length = 59" (1.5m) Patient Size: >40kg (>88 lb)	Pkg. wt. = 3oz (85g) Qty: 1 sensor	
M1195A CEI	Reusable Infant finger SpO ₂ sensor Length = 59" (1.5m) Patient Size: 4-15kg (8.8-33 lb)	Pkg. wt. = 3oz (85g) Qty: 1 sensor	
M1196A CEI	Reusable Pediatric/Adult finger clip SpO ₂ sensor. (length = 118" (3m) Patient Size: >40kg (>88 lb)	Pkg. wt. = 9.7oz (0.275kg) Qty: 1 sensor	
NOTE:	Refer to your instrument user guide for usage of Neonatal/Infant sensor with various Philips monitors.		

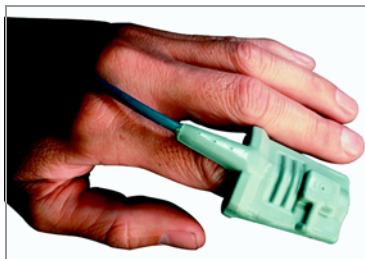

M1191A/B, M1191AL/BL, M1191T M1192A, M1192T

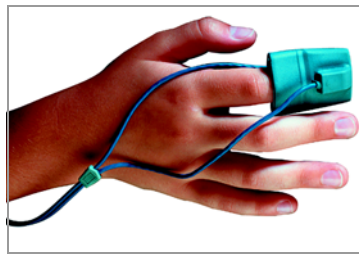

M1193A, M1193T



M1194A



M1195A



M1196A

Philips Reusable SpO₂ Sensors with 9-pin D-Sub Connector

Product No.	Description	Packaging Information	Philips & Nellcor Instruments
M1191T CE	Reusable Adult finger SpO ₂ sensor. Length = 17" (45cm) Patient Size: >50kg (>110 lb).	Pkg. wt. = 5oz (150g) Qty: 1 sensor	Refer to chart on page 9-12 and 9-13 for instrument compatibility.
M1192T CE	Reusable Pediatric finger SpO ₂ sensor. Length = 17" (45cm) Patient Size: 15-50 kg (33-110 lb).	Pkg. wt. = 5oz (150g) Qty: 1 sensor	
M1193T CE	Reusable Neonatal foot/hand SpO ₂ sensor. Length= 35" (90cm) Patient Size: 1-4 kg (2.2 - 8.8 lb).	Pkg. wt. = 5oz (150g) Qty: 1 sensor	
M1196T CE	Reusable Pediatric/Adult finger clip SpO ₂ sensor. Length = 35" (90cm) Patient Size: >40kg (>88 lb).	Pkg. wt. = 8.5oz (0.240kg) Qty: 1 sensor	
NOTE:	Refer to your instrument user guide for usage of Neonatal/Infant sensor with various Philips monitors.		



M1191T

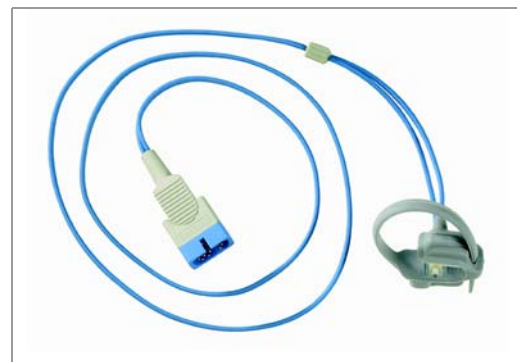

M1193T



M1196T

Philips SpO₂ Adapter Cables and Accessories

Product No.	Description	Packaging Information	
M1900B CEI	Adapter Cable (12 pin to 9 pin D-sub input connector) Length =9.8' (3m)	1 cable	Pkg. wt. = 5oz (142g)
M1940A CEI	Adapter Cable (12 pin to 8 pin input connector) Length = 6.6' (2m)		Pkg. wt. = 4oz (113g)
M1941A CEI	Extension Cable (8 pin to 8 pin input connector) Length = 6.6' (2m)		Pkg. wt. = 4oz (113g)
M1943A CEI	Adapter Cable (8 pin to 9 pin D-sub input connector) Length= 3.3' (1m)		Pkg. wt. = 3oz (85g)
M1943AL CEI	Adapter Cable (8 pin to 9 pin D-sub input connector) Length=9.8' (3m)		Pkg. wt. = 5oz (142g)
M1943NL CEI	Adapter Cable, OxiMax [®] -compatible (8 pin to 9 pin D-sub input connector) Length = 9.8' (3m)		Pkg. wt. = 5oz (142g)
M1627A	Velcro straps for M1191A/B SpO ₂ sensors	(10/pack)	Pkg. wt. = 3oz (85g)



M1900B



M1940A

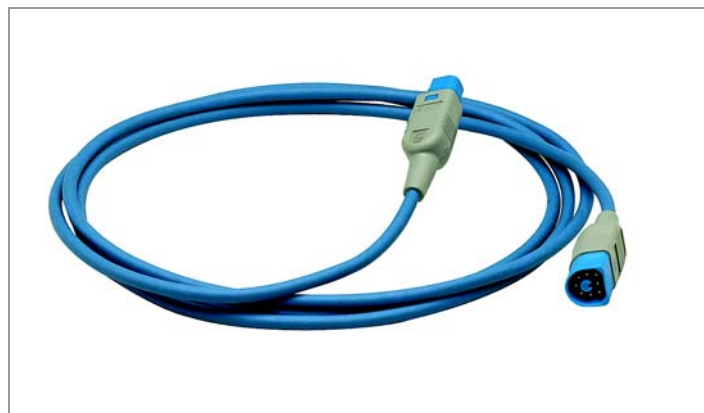

M1941A

Masimo® Reusable SpO₂ Sensors

Philips Order No.	Description	Packaging Information	Philips Instrument
9898031 40321 CEI	LNOP® DCI Adult reusable finger sensor Length: 36" (91cm) Patient size: >30kg (>66 lb)	Pkg.wt.= 3 oz (0.08kg) Qty: 1 sensor	Refer to chart on page 9-12 and 9-13 for instrument compatibility.
9898031 40331 CEI	LNOP DCIP Pediatric reusable finger sensor Length: 36" (91cm) Patient size: 10-50kg (22-110 lb)	Pkg.wt.= 3 oz (0.08kg) Qty: 1 sensor	
9898031 40341 CEI	LNOP TC-I Adult ear sensor Length: 36" (91cm) Patient size: >30kg (>66 lb)	Pkg.wt.= 3 oz (0.08kg) Qty: 1 sensor	
9898031 48281 CEI	LNCS® DC-I Adult digi-clip sensor Length: 36" (91cm) Patient size: >30kg (>66 lb)	Pkg.wt.= 15.9oz (0.450kg) Qty: 1 sensor	
9898031 48291 CEI	LNCS DC-IP Pediatric clip sensor Length: 36" (91cm) Patient size: 10-50kg (22-110 lb)	Pkg.wt.= 15.9oz (0.450kg) Qty: 1 sensor	
9898031 48301 CEI	LNCS TC-I Adult tip-clip sensor Length: 36" (91cm) Patient size: >30kg (>66 lb)	Pkg.wt.= 15.9oz (0.450kg) Qty: 1 sensor	
9898031 48311 CEI	LNCS TF-I forehead sensor with head band. Length: 36" (91cm) Patient size: >30kg (>66 lb)	Pkg.wt.= 15.9oz (0.450kg) Qty: 1 sensor	



9898031 40321



9898031 40331

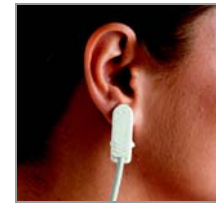

9898031 40341



9898031 48281



9898031 48291



9898031 48311

Masimo Adapter Cables

Product No.	Description	Packaging Information
M1020-61100 CEI	Adapter cable for connecting Masimo LNOP reusable sensors to Philips IntelliVue, SureSigns and Masimo SET Module and Multi-Measurement Server. Length: 11.8' (3.6m)	Pkg.wt.= 8.8 oz (0.25kg) Qty: 1 cable
M1020-61102 CEI	Adapter cable for connecting Masimo LNOP reusable sensors to Viridia M1020A module. Length: 11.8' (3.6m)	Pkg.wt.= 8.8 oz (0.25kg) Qty: 1 cable
9898031 48221 CEI	Adapter cable for connecting Masimo LNCS reusable sensors to Philips IntelliVue, SureSigns and Masimo SET Module and Multi-Measurement Server. Length: 10' (3m)	Pkg.wt.= 8.8 oz (0.25kg) Qty: 1 cable

Nellcor[®] Reusable Durasensor[®] and Cables

Product Number	Description	Packaging Information	Use with Philips Instrument
M4789A CEI	Nellcor SpO ₂ Durasensor	Pkg. wt. = 0.3 lb (136g) Qty: 1 sensor	Refer to chart on page 9-12 and 9-13 for instrument compatibility.
M4780A CEI	Extension cable for VS1. Use with Durasensor M4789A.	Pkg. wt = 0.36 lb (163g) Qty: 1 cable	
M4787A CEI	Extension cable. Use with Durasensor M4789A. Length=8 ft. (2.4m)		

Disposable SpO₂ Sensors and Accessories

Philips Disposable SpO₂ Sensors

Product No.	Description	Packaging Information	Philips Instrument
M1131A CEI	Single Patient Adult/Pediatric Disposable SpO ₂ finger sensor. Length = 18" (45cm) Patient Size: >20kg (>44 lbs)	Pkg. wt. = 1.5 lbs (700g) Qty: 20 sensors	Refer to chart on page 9-12 and 9-13 for instrument compatibility.
M1132A CEI	Single Patient Infant Disposable SpO ₂ sensor. Length = 35" (90cm) Patient Size: 3-10kg (6.6 lbs-22 lbs) Application site: any finger Alternate site: any toe	Pkg. wt. = 1.9 lbs (900g) Qty: 20 sensors	
M1133A CEI	Single Patient Neonatal/Adult Disposable SpO ₂ sensor. Length = 35" (90cm) Neonate Patient Size: <3kg (<6.6 lbs) Application site: neonate foot Alternate site: neonate hand Adult Patient Size: >40kg (>88 lbs) Application site: any finger except thumb Infant Patient Size: 10-20kg (22-44 lbs) Alternate site: infant big toe, infant thumb	Pkg. wt. = 2.1 lbs (970g) Qty: 20 sensors	



M1131A (Adult)



M1131A (Pediatric)



M1132A



M1133A

Masimo Adhesive LNOP SpO₂ Sensors

Philips Order No.	Description	Packaging Information	Philips Instrument
9898031 40231 CEI	LNOP Adt Adult finger sensor Patient size: >30kg (>66 lb)	5.6oz (0.16 kg) 1 box of 20 sensors	Refer to chart on page 9-12 and 9-13 for instrument compatibility.
9898031 40261 CEI	LNOP Pdt Pediatric finger sensor Patient size: 10-50kg (22-110 lb)	5.6oz (0.16 kg) 1 box of 20 sensors	
9898031 40311 CEI	LNOP Inf-L Infant toe sensor Patient size: 3-20kg (6.6-44 lb)	7oz (0.20kg) 1 box of 20 sensors	
9898031 40291 CEI	LNOP Neo-L Neonatal foot sensor Patient size: <3kg or >40kg (<6.6 lb or >88 lb)	7oz (0.20kg) 1 box of 20 sensors	
9898031 40271 CEI	LNOP Neo Neonatal toe sensor Patient size: <10kg (<22 lb)	7.6oz (0.22kg) 1 box of 20 sensors	
9898031 40301 CEI	LNOP SofTouch Neo Pt-L Neonatal foot sensor. Patient size: <1kg (<2.2 lb)	7oz (0.20kg) 1 box of 20 sensors	
9898031 40281 CEI	LNOP SofTouch NeoPt Neonatal foot sensor. Patient size: <1kg (<2.2 lb)	7.6oz (0.22kg) 1 box of 20 sensors	
9898031 40351	Replacement Poseys for LNOP SofTouch NeoPt Neonatal sensors	14oz (0.40kg) 12 per pack	n/a
9898031 40361	Replacement tapes	28oz (0.80kg) 100 per pack	n/a

989803140231



989803140261



989803140311



989803140291



989803140271



989803140301



989803140281



Masimo LNCS Adhesive SpO₂ Sensors

Philips Order No.	Description	Packaging Information	Philips Instrument
9898031 48231 CE	LNCS Adt Adult finger sensor Patient size: >30kg (>66 lb)	Pkg.wt.= 5.6oz (0.16 kg) 1 box of 20 sensors	Refer to chart on page 9-12 and 9-13 for instrument compatibility.
9898031 48241 CE	LNCS Pdtx Pediatric finger sensor Patient size: 10-50kg (22-110 lb)	Pkg.wt.= 5.6oz (0.16 kg) 1 box of 20 sensors	
9898031 48251 CE	LNCS Inf-L Infant toe sensor Patient size: 3-20kg (6.6-44 lb)	Pkg.wt.= 7oz (0.20kg) 1 box of 20 sensors	
9898031 48261 CE	LNCS Neo Neonatal foot sensor Patient size: <1kg (<2.2 lb)	Pkg.wt.= 7.6oz (0.22kg) 1 box of 20 sensors	
9898031 48271 CE	LNCS Neo-L Neonatal foot sensor Patient size: <3kg or >40kg (<6.6 lb or >88 lb)	Pkg.wt.= 7oz (0.20kg) 1 box of 20 sensors	



9898031 48231



9898031 48241



9898031 48251



9898031 48261



9898031 48271

OxiMax[®] Disposable SpO₂ Sensors

Philips Order No.	Description	Packaging Information	Philips Instrument
M1901B* CE I	SpO ₂ OxiMax [®] sensor for Neonatal foot or Adult digit. Recommended patient size: <3kg to >40kg (<7 to >88 lb) Available from Philips only in Europe and Japan	Pkg. wt.= 1.9 lb (879g) 1 case = 24 sensors	Refer to chart on page 9-12 and 9-13 for instrument compatibility.
M1902B CE I	SpO ₂ OxiMax [®] sensor for Infant digit. Recommended patient size 3 to 20kg (7 to 44 lb). Available from Philips only in Europe and Japan	Pkg. wt.= 1.9 lb (879g) 1 case = 24 sensors	
M1903B CE I	SpO ₂ OxiMax [®] sensor for Pediatric digit. Recommended patient size 10 to 50kg (22 to 110 lb). Available from Philips only in Europe and Japan	Pkg. wt.= 1.6 lb (709g) 1 case = 24 sensors	
M1904B CE I	SpO ₂ OxiMax [®] sensor for Adult digit. Recommended patient size >30kg (>66 lb). Available from Philips only in Europe and Japan	Pkg. wt.= 1.5 lb (680g) 1 case = 24 sensors	

* Refer to your instrument User's Guide regarding the use of neonatal/infant sensors.



M1901B



M1902B



M1904B

SpO₂ Sensor Adapter Cables

Product No.	Description	Packaging Information	
M1900B CEI	Adapter cable (12-pin to 9-pin D-sub input connector). Length= 9.8' (3m)	5oz (142g)	1 cable per box
M1943A CEI	Adapter cable (8-pin to 9-pin D-sub input connector). Length: 3.3' (1m)	35oz (100g)	
M1943AL CEI	Adapter Cable (8-pin to 9-pin D-sub input connector). Length: 9.8' (3m)	4oz (117g)	
M1943NL CEI	Adapter Cable, OxiMax [®] -compatible MMS/Module (8-pin to 9-pin D-sub input connector). Length: 9.8' (3m)	4oz (117g)	
M1020-61100 CEI	Adapter cable for connecting Masimo LNOP reusable sensors to Philips IntelliVue and Masimo SET Module and Multi-Measurement Server. Length: 11.8' (3.6m)	9oz (250g)	
M1020-61102 CEI	Adapter cable for connecting Masimo LNOP reusable sensors to Viridia M1020A module. Length: 11.8' (3.6m)		
9898031 48221 CEI	Adapter cable for connecting Masimo LNCS reusable sensors Philips IntelliVue and Masimo SET Module and Multi-Measurement Server. Length: 10' (3m)		



M1900B

SpO ₂ Sensor Compatibility Chart		Philips 8-pin Sensors				Philips 9-Pin Sensors			Masimo		OxiMax 9-Pin Sensors								
		Reusable				Reusable			Disposable and Reusables Available from Philips		Disposable								
		Soft Glove		Clip		M113x Family			Soft Glove		Clip		Available from Philips in Europe and Japan only.						
		M1191A or B	M1191AL or BL	M1192A	M1193A	M1194A	M1195A	M1196A	M1191T	M1192T	M1193T	M1196T	MASIMO LNCS	MASIMO LNOP	M1901B	M1902B	M1903B	M1904B	
Monitoring Equipment	Adapter Cable	C3 (862474, 862478)	No Adapter Cable Required	•	•	•	•	•	•	•	•	•	•	•	•	•	•		
			M1941A Extension Cable (2m) can be used.	•	•	•	•	•	•	•	•	•	•	•	•	•	•	•	
			M1943A (1m)							•	•	•	•	•	•	•	•	•	
		A3 (M3926A, M3927A, M3928A, M3929A)	M4787A Extension Cable (2.4m)							•	•	•	•	•	•	•	•	•	•
			No Adapter Cable Required	•	•	•	•	•	•	•	•	•	•	•	•	•	•	•	•
		Suresigns VM Monitors (863063, 863064, 863065, 863066, 863068, 863077)	M1941A Extension Cable (2m) can be used.	•	•	•	•	•	•	•	•	•	•	•	•	•	•	•	•
			M1020-61100																
			989803148221																
			M1943A (1m)							•	•	•	•	•	•	•	•	•	•
			M1943AL (3m)							•	•	•	•	•	•	•	•	•	•
			Suresigns VS3 Monitors (863071, 863072, 863073, 863074)	No Adapter Cable Required	•	•	•	•	•	•	•	•	•	•	•	•	•	•	•
M1941A Extension Cable (2m) can be used.	•			•	•	•	•	•	•	•	•	•	•	•	•	•	•	•	
M1943A (1m)									•	•	•	•	•	•	•	•	•	•	
M1943AL (3m)									•	•	•	•	•	•	•	•	•	•	
Hearstart XLT (M3500B) Hearstart 4000 (M15500B) Hearstart XL (M4735A) Hearstart MRx (M3535A, M3536A) (note: M1193A and M1195A only compatible with HearStart MRx)	No Adapter Cable Required		•	•	•	•	•	•	•	•	•	•	•	•	•	•	•	•	
	M1941A Extension Cable (2m) can be used.	•	•	•	•	•	•	•	•	•	•	•	•	•	•	•	•		
	M1943A (1m)							•	•	•	•	•	•	•	•	•	•		
	M1943AL (3m)							•	•	•	•	•	•	•	•	•	•		
Viridia Transmitter M2601A	No Adapter Cable Required	•	•	•	•	•	•	•	•	•	•	•	•	•	•	•	•		
	M1941A Extension Cable (2m) can be used.	•	•	•	•	•	•	•	•	•	•	•	•	•	•	•	•		
	M1943A (1m)							•	•	•	•	•	•	•	•	•	•		
Transmitter M2601B (862108) Intellivue TRx4841A (862439), TRx4851A (862231)	No Adapter Cable Required	•	•	•	•	•	•	•	•	•	•	•	•	•	•	•	•		
	M1941A Extension Cable (2m) can be used.	•	•	•	•	•	•	•	•	•	•	•	•	•	•	•	•		
Nellcor N200, N3000, N395, N-20 PA, NPB-40	M1943A (1m)							•	•	•	•	•	•	•	•	•	•		
	No Adapter Cable Required	•	•	•	•	•	•	•	•	•	•	•	•	•	•	•	•		
GE Dinamap Pro400 V1	GE Adapter Cable Required																		

Notes



Chapter 10

Ultrasound Imaging Supplies

For Information About	See Page
Ultrasound Imaging Supplies	10-2
TEE Supplies	10-3
Imaging Paper	10-5

Products labeled with a CE mark indicates compliance with the EU Medical Devices Directive.

Ultrasound Imaging Supplies

Ultrasound Imaging Supplies

Product Number	Description	Packaging Information		Use with Philips Instrument
13920B	1/2" Industrial grade VHS cassette, T120, (manufactured by Maxell).	1 case = 10 tapes	Pkg. wt. = 6 lb 1oz (2.75kg)	776XX VHS recorders
13921B	1/2" SuperVHS cassette, (manufactured by Maxell).		Pkg. wt. = 6 lb 9oz (2.98kg)	77612A 77622A recorders
40483A CE See photo	Ultrasound transmission gel. Water soluble, easy patient cleanup. Plastic 8-1/2oz (0.25L) refillable squeeze bottles. Worldwide availability. Order refill 40483B below.	1 box = 12 bottles	Pkg. wt. = 8 lb (3.63kg)	Shelf life: At least 2 years Ultrasound transducers
40483B CE	Ultrasound transmission gel. Water soluble, easy patient cleanup. Large dispenser size, 5 liter container, used to refill 40483A above.	1 box = 5 liter bottle	Pkg. wt. = 11 lb 15oz (5.41kg)	



40483A

TEE Supplies

TEE Supplies

Product Number	Description	Packaging Information		Use with Philips Instrument
40487A CE See photo	Transesophageal transducer sheath kit, includes 10 disposable latex sheaths and tubes, 10 syringes, 10 ultrasound sterile gel packets (15g), 2 applicators, and instructions. Non-sterile.	1 box = 10 procedures	Pkg. wt. = 1 lb 8oz (709g)	21362A/B/C 21363A Bi-Plane 21364A Omni I 21367A Omni II 21369A Omni II
M1828A CE See photo	Disposable TEE bite guard for adults, for use with Agilent's Transesophageal transducers. Non-sterile.	1 case = 24 guards	Pkg. wt. = 14oz (397g)	21378A Omni III 21478A Omni III
21110A	TEE transducer disinfection basin and lid.	1 basin and 1 lid	Pkg. wt. = 6.40 lbs (2.9kg)	Philips TEE Transducers
M2273A	Tip protector for OmniPlane TEE transducer. Disposable, not intended for reuse. Each protector individually bagged. Made of PVC plastic. Non-sterile.	1 case = 24 protectors	Pkg. wt. = 1 lb 4oz (567g)	21363A Bi-Plane 21367A Omni II 21369A Omni II



40487A



M1828A

TEE Supplies (Continued)

Product Number	Description	Packaging Information		Use with Philips Instrument
M2203A LATEX CE See photo	Disposable MiniTEE bite guards for use with Agilent 21365A MiniTEE transducer. Includes rubber head straps. Non-sterile.	1 case = 24 guards	Pkg. wt. = 1 lb 4oz (567g)	21381A Mini Multi-Plane TEE, 21365A MiniTEE, 21366A Pediatric Bi-Plane TEE
M2243A See photo	Tip protector for OmniPlane TEE transducer. Disposable, not intended for reuse. Each protector individually bagged. Made of PVC plastic. Non-sterile.	1 case = 24 tip protectors	Pkg. wt. = 1 lb (454g)	21364A Omni I TEE
M4604A	Tip protector for Omni Plane III TEE transducer. Disposable, not intended for reuse. Each protector individually bagged. Made of nontoxic black plastisol. Non-sterile.	1 case = 24 tip protectors	Pkg. wt. = 1.5 lb (680g)	21378A 21478A Omni III TEE



M2203A



M2243A

Imaging Paper

Ultrasound Imaging Systems and Recorders

Recorder Manufacturer	Philips Recorder Product Number	System or Philips 770XXA Imaging System Option	Manufacturer Recorder Product Number	Manufacturer Paper Product Number	Philips Paper Product Number
Kowa	77510A	C80 thru C85 M2424A	TLR 111	KRP10-002A	40479A
Mitsubishi	77570A 77570B	C70, C71	P70, P72	K70S	40458A

Notes



Chapter 11

Miscellaneous Supplies

For Information About	See Page
Batteries	11-2
Miscellaneous Supplies	11-4
Stethoscope Parts	11-6

Products labeled with a CE mark indicates compliance with the EU Medical Devices Directive.

Batteries

AECG/Holter and Transport Monitor

Product Number	Description	Packaging Information		Use with Instrument
40488A	Rechargeable sealed 12V lead acid battery for V24/V26 and transport monitor.	1 battery	Pkg. wt. = 1.8 lb (680g)	M1275A M1205A

PageWriter Cardiograph Batteries

Product Number	Description	Packaging Information		Use with Instrument
M1721A see photo	12-volt lead-acid battery assembly for PageWriter XL cardiographs. Shelf life: at least 1 month	1 box = 1 assembly	Pkg. wt. = 9 lbs (4.08kg)	M1700A/ M1701A/ M1702A
M2460A	6-volt lead-acid battery assembly for PageWriter 100/200/200i/300i. Shelf life: at least 1 month		Pkg. wt. = 5.12 lbs (2.6 kg)	M1770A M1771A M1772A
M3941A	Rechargeable battery for PageWriter 10/10i	1 battery	Pkg. wt. = 12.3 oz (350g)	M2662A
9898031 29131	Lithium Ion Battery for PageWriter Touch (requires 2 batteries).	1 battery	Pkg. wt. = 1.08 lbs (490g)	860284
9898031 30151	12-volt Rechargeable lead-acid battery assembly for PageWriter Trim	1 battery	Pkg. wt. = 2.2 lbs (1kg)	860286 860287 860288 860290



M1721A

Telemetry Batteries

Product Number	Description	Packaging Information		Use with Instrument
40455A	Zinc air battery for use in telemetry and other high duty cycle systems, 8.4V. Shelf life: at least 9 months	1 box = 12 batteries	Pkg. wt. = 12 oz. (336g)	78100A M1400A M2600A
ULBU9VLJ	Lithium 9V battery. Shelf life: at least 10 months	1 box = 10 batteries	Pkg. wt. = 11 oz. (308g)	M2600A M2601A
M4790A	Rechargeable battery pack.	1 box = 1 combiner	Pkg. wt. = 1.1 lb (499g)	M2636B

IntelliVue MP20/30, MP40/50, MP2/X2 Battery

Product Number	Description	Packaging Information		Use with Instrument
M4605A	Lithium Ion 10.8V battery	1 battery	Pkg. wt. = 1.06 lbs (.480kg)	M8027A M8003A M8004A
M4607A		1 battery	Pkg. wt. = 5.6 oz. (.160kg)	M8102A M3002A

SureSigns VM4, VM3 VM6, VM8, VS3 Battery

Product Number	Description	Packaging Information		Use with Instrument
9898031 44631	Lithium Ion battery	1 battery	Pkg. wt. = 1.4 lbs (.650kg)	863063 (VM4) 863064 (VM6) 863065 (VM6) 863066 (VM8) 863068 (VM8) 863069 to 863074 (VS3) 863077 (VM3)

Miscellaneous Supplies

Telemetry Pouches and Covers

Product Number	Description	Packaging Information		Use with Instrument
9300-0768-050	Disposable water and chemical resistant white telemetry pouch with snaps. One size fits all.	1 box/50 pouches	Pkg. wt. = 12 oz (336g)	78100A M1400A M2600A
9300-0768-200		1 case/4 boxes of 50	Pkg. wt. = 6.4 lb (2.89kg)	
9898031 37831	Transceiver pouch with shoulder strap with viewing window.	1 box/50 pouches	Pkg. wt. = 1.76 lb (.800kg)	862231 (TRx4851A) 862439 (TRx4841A) 862108 (M2601B) IntelliVue Telemetry
9898031 40371	Transceiver pouch with shoulder strap with viewing window.	1 case/4 boxes of 50	Pkg. wt. = 6.37 lb (2.83kg)	
9898031 40431	TeleMon service port protective cover for TRx (ECG only transceiver/transmitter).	1 pack of 10	Pkg. wt. = 0.35oz (.010kg)	
9898031 40451	TeleMon service port protective cover for TRx+ (ECG and SpO ₂ transceiver/transmitter)			
9898031 40441	SpO ₂ Connector protective cover			



9898031 37831, 9898031 40371

Cases, Accessory Bags, Pouches and DVD Media

Product Number	Description	Packaging Information		Use with Instrument
M2463A	Carrying case for PageWriter 100, 200, 200i, 300i.	1 case	Pkg. wt. = 2 lbs. (896g)	M1770A M1771A M1772A
M3919A	Canvas Tote Bag	1 bag	Pkg. wt. = 2.25 lbs. (1.03kg)	FM2 A1 A3
M3920A	Snap-on Accessory Bag	1 bag	Pkg. wt. = 4.4 oz. (125.6g)	M3919A Bag
9898031 36651	Digitrak Plus Pouch	1 pouch	Pkg. wt. = 2.1 oz. (0.06kg)	860277 DigiTrak Plus Holter Monitor
9898031 37961	StressVue Pouch for exchange wireless patient module labeled "X12"	1 pouch	Pkg. wt. = 3.5 oz. (.100kg)	StressVue Wireless Patient Module
9898031 44351	StressVue Pouch for exchange wireless patient module labeled "X12+"			
9898031 37971	StressVue velcro belt with pouch for wired patient module		Pkg. wt. = 15.8 oz. (.450kg)	StressVue Wired Patient Module
9898031 51051 CE	Medical Grade DVD+RW Storage Capacity: 4.7 GB Recording Speed: 1-4X Shelf life: >100 years with validated Philips devices.	10 packs of 10 slim jewel cases = 100 DVDs	Pkg. wt. = 15.5 lbs. (7.060kg)	For use in drives/ recorders that support 4X DVD+RW Standard including Philips MR instruments Achieva 1.5T and 3.0T, Panorama 1.0T, Intera 1.5T R11 and later, Intera 1.0T R11 and later.
9898031 53441	X2/MP2 Carrying Strap. Comes with cable organizer.	1 strap	Pkg. wt. = 4.23oz (120kg)	M8102A, M3002A
9898031 57171	X2/MP2 Anti-slip Pad	5 per bag	Pkg. wt. = 2 lbs. (.921kg)	



9898031 37961

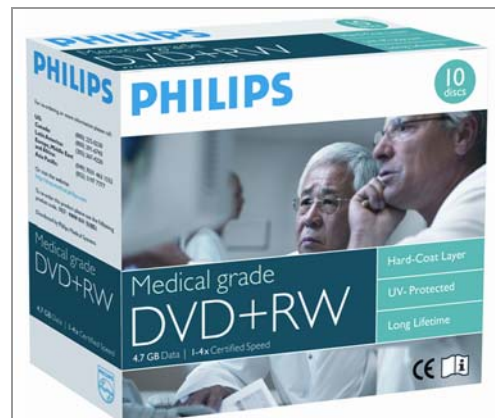

9898031 51051

Stethoscope Parts

Replacement Parts for M4530A/M4534A Electronic Stethoscopes

Product Number	Description	Packaging
M4504-60000	Eartips soft, 12.7mm	1 pack = 1 pair
M4504-60010	Eartips firm, 13.3mm	
M4530-60020	Diaphragm	1 each
M4530-60030	Non-chill ring	
M4530-60040	Battery cover	
M4530-60050	3V Lithium battery	1 battery
M4530-91000	User's manual	1 each

Replacement Parts for M4504A/M4513A Electronic Stethoscopes

Product Number	Description	Packaging
M4504-60000	Eartips soft, 12.7mm	1 pack = 1 pair
M4504-60010	Eartips firm, 13.3mm	
M4504-60030	Non-chill ring	1 each
M4504-91000	User's manual	1 each



Electronic Stethoscope Replacement Parts

Original Rappaport-Sprague Stethoscope Replacement Kits

Kit Part Number	Kit Description
280-100-C25	Small eartip, 2 pair/package
280-100-C26	Large eartip, 2 pair/package
280-100-C27	Adult Chest Piece Kit. Contains the following:
	1 large adult diaphragm
	1 large adult bell (3.5cm)
280-100-C30 LATEX	1 small adult bell (2.5cm)
	18" Standard Reconditioning Kit. Contains the following:
	1 binaural spring
	1 hose clip
	2 plastic sleeves
2 (18") hoses	
280-100-C31 LATEX	24" Standard Reconditioning Kit Contains the following:
	1 binaural spring
	1 hose clip
	2 plastic sleeves
	2 (24") hoses

Notes



Chapter 12

Defibrillator/AED Supplies

For Information About	See Page
DEFIBRILLATOR SUPPLIES/ACCESSORIES	12-2
External Pads and Cables	12-2
Adapter Cable Test Loads	12-4
Pad Adapters	12-4
External Paddle Sets	12-5
Replacement Electrodes	12-5
Internal Paddles	12-6
Sync Cables	12-7
HeartStart MRx Accessories	12-9
Q-CPR™ Compression Sensor	12-10
Data Management Solutions	12-11
AED SUPPLIES AND ACCESSORIES	12-12
AED Pads and Accessories	12-12
AED Data Management Solutions	12-15
AED Cases and Wall Mount Solutions	12-17
AED Training Materials	12-20

Products labeled with a CE mark indicates compliance with the EU Medical Devices Directive.

DEFIBRILLATOR SUPPLIES/ACCESSORIES

Pads and paddles come in multiple sizes to meet the needs of adult, pediatric and infant patients. To order your defibrillator supplies in the U.S. call (800) 225-0230.

External Pads and Cables

Disposable External Multifunction Electrode Pads

Product No.	Description	Shelf Life	Sets/Case	For Philips Instrument
M3713A CE	HeartStart Adult Plus Pads with plug-style connector	24 mths from date of mfgr.	10	E, S, EM (Heartstream ForeRunner AED) 940010XX, 940020XX, 940030XX (Heartstart FR AED), M3860A, M3861A, M3840A, M3841A (Heartstream/HeartStart FR2 AED) M3500B (Heartstream/HeartStart XLT) M3535A/M3536A/M3536j (HeartStart MRx/MRxE) M4735A (Heartstream/HeartStart XL) M5500B (Heartstart 4000)
M3716A CE	HeartStart Adult Radiolucent Pads with plug style connector			
M3718A CE	HeartStart Adult Radiotransparent/ Reduced Skin Irritation Pads with plug style connector			
M3717A CE	HeartStart Pediatric Plus Pads with plug style connector		5	M3500B (Heartstream/HeartStart XLT) M3535A/M3536A/M3536j (HeartStart MRx/MRxE) M4735A (Heartstream/HeartStart XL) M5500B (Heartstart 4000)
M3719A CE	HeartStart Pediatric Radiotransparent/ Reduced Skin Irritation Pads with plug style connector			
M3501A AAMI	Philips Adult Pads with barrel style connector		10	M3500B (Heartstream/HeartStart XLT) M3535A/M3536A (HeartStart MRx) M4735A (Heartstream/HeartStart XL) M5500B (Heartstart 4000)
M3502A IEC CE				
M3503A IEC CE	Philips Pediatric Pads with barrel style connector	5		
M3504A AAMI				

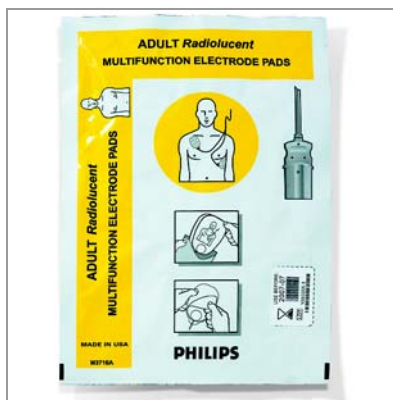

M3716A



M3717A



M3718A

External Multifunction Cables

Product No.	Description		For Philips Instrument
M3507A CE	Hands-free Pad cable	For use with Philips pads with barrel style connector. Can also be used with plug style connector pads with 05-10200 plug-to-barrel style connector adapter. Length: 2.1m (7 ft.)	M3500B (Heartstream/HeartStart XLT) M3535A/M3536A (HeartStart MRx) M4735A (Heartstream/HeartStart XL)
M3508A CE	HeartStart Hands-free Pad cable	For use with Philips pads with plug style connector Length: 2.1m (7 ft.)	M5500B (Heartstart 4000)
M4748A CE	HeartStart extension cable	Length = 10cm (4 in)	M4735A (Heartstream/HeartStart XL) M5500B (Heartstart 4000)



M3507A



M3508A

Pad Adapters

HeartStart Pad Adapters

Product No.	Description	Use with Instrument Models
05-10000 CE	Removable adapter	Medtronic Physio-Control LifePak 500, 9, 10c, 11, 12, 20
05-10100 CE	Removable adapter	Zoll 1200, 1400, 1600, and M-Series
05-10200 CE	Removable or permanent adapter	Fits Philips hands-free cable M3507A for connection to: M4735A (Heartstream/HeartStart XL) M5500B (Heartstart 4000) M3535A/M3536A (HeartStart MRx)

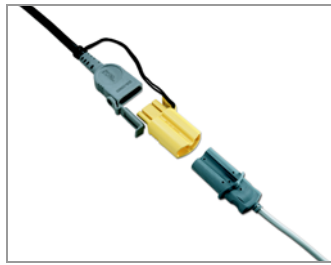

05-10000

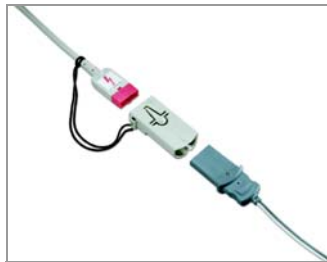

05-10100

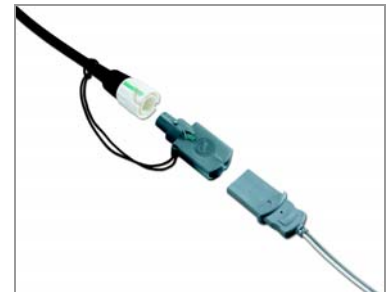

05-10200

Adapter Cable Test Loads

Test Loads

Product No.	Description
M1781A CE	50-ohm test load for M3507A Multifunction cables.
M3725A CE	HeartStart 50-ohm test load for the M3508A HeartStart Hands-Free cable. Also works with M3507A with 05-10200 plug-to-barrel style connector adapter.

External Paddle Sets

External Anterior/Anterior Paddle Sets

Product No.	For Philips Instrument	Sterilization
M3542A With PCI CE	M3535A/M3536A (HeartStart MRx)	Not designed to be sterilized. Refer to operating manual instructions for cleaning exterior surfaces.
M3543A With PCI CE (water resistant)	M3535A/M3536A (HeartStart MRx)	Not designed to be sterilized. Refer to operating manual instructions for cleaning exterior surfaces.
M4745A Without PCI CE	M4735A (Heartstream/HeartStart XL) M3535A/M3536A (HeartStart MRx)	Clean and sterilize according to operating manual instructions.
M4746A With PCI CE	M4735A (Heartstream/HeartStart XL)	Not designed to be sterilized. Refer to operating manual instructions for cleaning exterior surfaces.

Replacement Electrodes

Replacement Electrodes for External Paddle Sets

Product No.	Description	Philips External Paddles
M1789A CE	Rectangular Paddle Electrode Replacement (clip-on)	M4746A
M4759A	Rectangular Paddle Electrode Replacement (clip-on)	M3542A



M3542A

Internal Paddles

Switched Reusable Internal Paddles (Discharge Switch on Handle)

Product No.	Diameter	Sterilization	For Philips Instrument
M4741A CE	7.5cm (3in) Adult	Clean and sterilize according to operating manual instructions.	M4735A (Heartstream/HeartStart XL) M3535A/M3536A (HeartStart MRx)
M4742A CE	6cm (2.4in) Adult		
M4743A CE	4.5cm (1.8in) Pediatric		
M4744A CE	2.8cm (1.1in) Infant		

Switchless Reusable Internal Paddles (Discharge Switch on Defibrillator)

Product No.	Diameter	Sterilization	Use Adapter Cable	For Philips Instrument
M1741A CE	7.5cm (3in) Adult	Clean and sterilize according to operating manual instructions.	For M4735A and M3535A/ M3536A defibrillators use M4740A adapter cable	M4735A (Heartstream/ HeartStart XL) M3535A/M3536A (HeartStart MRx)
M1742A CE	6cm (2.4in) Adult			
M1743A CE	4.5cm (1.8in) Pediatric			
M1744A CE	2.8cm (1.1in) Infant			

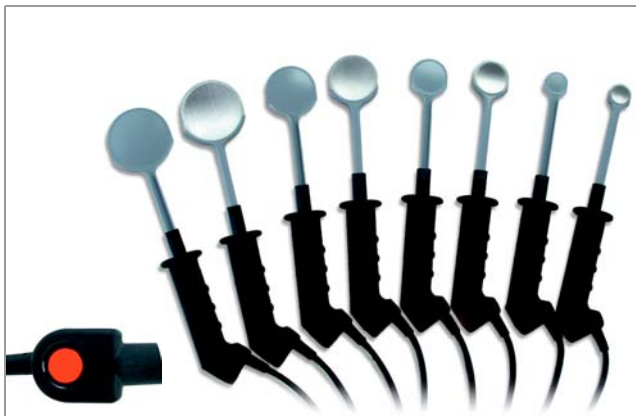

M4741A-M4744A



M1741A-M1744A

Internal Paddle Adapters

Product No.	Description	Length	Use With Internal Paddle Set	For Philips Instrument
M4740A CE	HeartStart Switchless Internal Paddle Adapter	20cm (8 in)	Switchless Reusable Internal Paddles M174xA series	M4735A (Heartstream/HeartStart XL) M3535A/M3536A (HeartStart MRx)
M4748A CE	HeartStart Extension Cable	10cm (4 in)	Switched Reusable Internal Paddles M474xA series	M4735A (Heartstream/HeartStart XL)



M4740A

Sync Cables

Sync Cables

Product No.	Connector	For Philips Defibrillators	Length
M1783A CE	12-pin	M4735A (Heartstream/HeartStart XL) M3535A/M3536A/M3536J (HeartStart MRx/MRxE)	2.5m (8ft)
M5526A CE	12-pin	M3535A/M3536A/M3536J (HeartStart MRx/MRxE) M4735A (Heartstream/HeartStart XL)	7.8m (25ft)

Defibrillator Batteries/Cases/Accessories

Defibrillator Batteries

Product No.	For Philips Instrument	Description	Shelf Life
M3506A CE	M3500B (Heartstream/HeartStart XLT) M4735A (Heartstream/HeartStart XL) M5500B (Heartstart 4000)	Battery charger adapter	N/A
M3516A CE	M3500B (Heartstream/HeartStart XLT) M4735A (Heartstream/HeartStart XL) M5500B (Heartstart 4000)	Sealed 12-volt lead acid (SLA) battery	At least 6 months
M3538A CE	M3535A/M3536A/M3536J (HeartStart MRx/MRxE)	14.8-volt Lithium Ion battery	N/A



M3516A



M3538A

Defibrillator Cases and Accessories

Product No.	Description	For Philips Instrument
M3509A	Carrying case	M3500B (Heartstream/HeartStart XLT)
M5509A	Carrying case	M5500B (HeartStart 4000)
M4751A	Accessory pouch (red)	M4735A (HeartStart XL)

HeartStart MRx Accessories

HeartStart MRx Accessories

Product No.	Description	Philips Instrument
M3537A CE	Bed Rail Hook	M3535A/M3536A/M3536J (HeartStart MRx/MRxE Monitor/Defibrillator)
M3541A CE	Carrying case (3 accessory pouches and shoulder strap)	
M3544A CE	Data Card Tray	
M3545A CE	Data Card and Tray	
M5521A CE	Color handle (Green)	
M5522A CE	Color handle (Blue)	
M5523A CE	Color handle (Yellow)	
M5524A CE	Color handle (Rose)	
M5525A CE	Color handle (Grey)	
M5528A	Vehicle Wall Mount	
M5529A	DC Power Module	



M5521A-M5525A

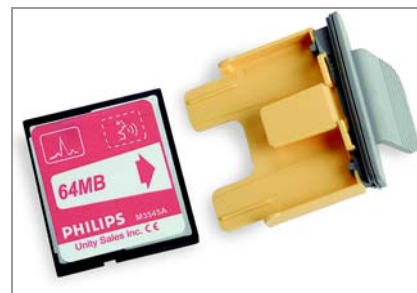

M3545A



M3541A



M5528A



M5529A

Q-CPR™ Compression Sensor

Q-CPR Compression Sensor and Accessories

Product Number	Description	Use with Philips Instrument
M4761A CE	Q-CPR Compression Sensor	M3535A, M3536A HeartStart MRx Defibrillator/Monitor
M4762A CE	Q-CPR Compression Sensor Adhesive Pads (10 pads)	M4761A Q-CPR Compression Sensor
M4763A CE	Pads/CPR Cable	M4761A Q-CPR Compression Sensor



M4761A Q-CPR Compression Sensor with
M4762A Q-CPR Compression Sensor Adhesive Pad



M4763A Pads/CPR Cable

Data Management Solutions

HeartStart Software and Data Card

Product No.	Description	For Philips Instrument
861276 CE	HeartStart Event Review Pro Software Full featured software that allows you to review and create reports on sudden cardiac arrest event data recorded by Philips defibrillators.	M3854A, M3524A (FR2 series data card and data card reader) M3500B (Heartstream/HeartStart XLT) M4735A (Heartstream/HeartStart XL) M3535A, M3536A, M3536J (HeartStart MRx/MRxE) M3860A, M3861A, M3840A, M3841A (Heartstream/HeartStart FR2 series AED) E, S, EM, (Heartstream ForeRunner AED) 940010XX, 940020XX, 940030XX (Heartstart FR AED) M5066A, M5067A, M5068A (HeartStart HS1 Defibrillators)
9898031 42521 CE	HeartStart 12-lead Transfer Station. Software product received a 12-lead ECG transmission from an appropriately equipped HeartStart MRx defibrillator, archives it and reliably forwards it to the appropriate hospital destination.	M3535A, M3536A/M3536J (HeartStart MRx/MRxE)
9898031 47711 CE	HeartStart data card (one card per order)	M4735A (Heartstream/HeartStart XL)
9898031 47721 CE		M3500B (Heartstream/HeartStart XLT) M5500B (HeartStart 4000)

AED SUPPLIES AND ACCESSORIES

Philips has everything you need to implement your early defibrillation program productively in the workplace, public setting, school, healthcare facility and public safety arena. To order AED supplies in the U.S. call: 1-800-263-3342.

AED Pads and Accessories

External AED Pads

Product No.	Description	Quantity	Philips Instrument
DP2 CE	Self-adhesive adult electrode pads with integrated cable and connector for patients weighing 55 lbs. (25kg) or more or 8 years and above.	2 sets	E, S, EM (Heartstream ForeRunner AED) 940010XX, 940020XX, 940030XX (Heartstart FR AED)
DP6 CE	Self-adhesive adult electrode pads with integrated cable and connector for patients weighing 55 lbs. (25kg) or more or 8 years and above.	6 sets	M3860A, M3861A, M3840A, M3841A (Heartstream/HeartStart FR2 Series AED)
M3870A CE	Self-adhesive FR2 series infant/child electrode pads. Reduced energy (50 Joules) providing more appropriate dosage for infants and children under 8 years old or 55 lbs (25kg).	1 set	For use with the Heartstream and HeartStart FR2 Series AED models only: M3860A, M3861A, M3840A, M3841A
M5071A CE	Adult SMART Pads Cartridge for patients weighing 55 lbs (25kg) or more or 8 years and above.	1 set	M5066A, M5067A, M5068A (HeartStart HS1 Defibrillators)
M5072A CE	Infant/Child SMART Pads Cartridge for infants/children under 8 years old or 55 lbs. (25kg).	1 set	M5066A, M5067A, M5068A (HeartStart HS1 Defibrillators)
9898031 39261 CE	SMART Pads II for adults, infants and children.	1 set	861304, 861305 (HeartStart FRx Defibrillators)

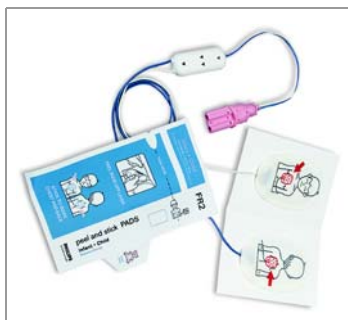

M3870A

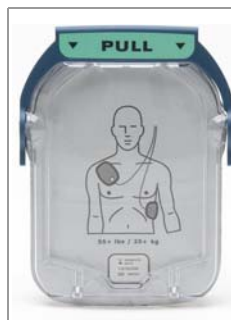

M5071A



M5072A



989803139261

AED Batteries

Product No.	Description	Shelf Life	Philips Instrument
BT1 CE	ForeRunner lithium manganese dioxide battery	5 year shelf life plus 1 year standby life	E, S, EM (Heartstream ForeRunner AED) 940010XX, 940020XX, 940030XX (Heartstart FR AED)
M3848A CE	FR2+ rechargeable battery	2.5 years shelf life 6 month standby life	M3860A, M3861A, M3840A, M3841A (HeartStart FR2+ AED sold after 12/01/01)
M3849A CE	Charger for the FR2+ rechargeable battery	na	
M3863A CE	FR2 series lithium manganese dioxide battery	5 year shelf life plus typical 5 year standby life	M3860A, M3861A, M3840A, M3841A (Heartstream/HeartStart FR2 Series AED)
M5070A CE	Battery for HeartStart HS1/FRx defibrillators (lithium manganese dioxide)	5 year shelf life plus typical 4 year standby life	M5066A, M5067A, M5068A (HeartStart HS1 Defibrillators) 861304, 861305 (HeartStart FRx Defibrillators)
9898031 36291 CE	Battery-Aviation-LiMnO ₂ - FR2 series. Meets requirements of FAA TSO C-142 regulation for use on commercial aircraft.	5 year shelf life plus typical 5 year standby life	M3860A, M3861A, M3840A, M3841A (Heartstream/HeartStart FR2 Series AED)
9898031 36301 CE	Battery-Aviation-LiMnO ₂ - ForeRunner Meets requirements of FAA TSO C-142 regulation for use on commercial aircraft.	5 year shelf life plus 1 year standby life	E, S, EM (Heartstream ForeRunner AED) 940010XX, 940020XX, 940030XX (Heartstart FR AED)



M3848A, M3849A



M3863A

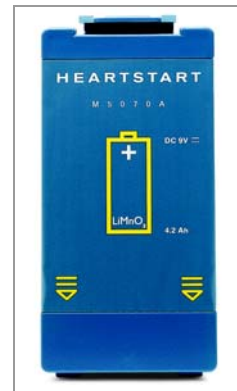

M5070A

AED Accessories and Kits

Product No.	Description	Philips Instrument
M3873A AAMI	FR2+ ECG Assessment Module. 3-wire ECG module lets you use FR2+ with ECG display to assess ECG of responsive, breathing, but at-risk patient. (AAMI lead colors).	M3840A, M3860A (HeartStart FR2+ AED with ECG sold after 12/01/01)
M3874A IEC CE	FR2+ ECG Assessment Module. 3-wire ECG module lets you use FR2 series with ECG display to assess ECG of responsive, breathing, but at-risk patient. (IEC lead colors).	
68-PCHAT	AED Fast Response Kit. Kit includes two pairs of nitrile gloves, one CPR mask, one paramedic scissors, one prep razor, one large reinforced paper towel. All items contained in a zippered pouch that attaches to the AED carrying case.	E, S, EM (Heartstream ForeRunner AED) 940010XX, 940020XX, 940030XX (Heartstart FR AED) M3860A, M3861A, M3840A, M3841A (Heartstream/HeartStart FR2 series AED) M5066A, M5067A, M5068A (HeartStart HS1 Defibrillators) 861304, 861305 (HeartStart FRx Defibrillator)
9898031 39311 CE	Infant/Child Key used in infant/child defibrillation with the HeartStart FRx Defibrillator. For infants and children under 8 years old or <55 lbs. (<25kg).	861304, 861305 (HeartStart FRx Defibrillator)

AED Electrode Pad Adapters

- for cross-product compatibility between FR/FR2/FRx series pads and manual defibrillators

Product No.	Description	Defibrillator Models
05-10000 CE	AED QUIK-COMBO electrode adapter	Medtronic Physio-Control LifePak 9, 10c, 11, 12, 500, 20
05-10100 CE	AED Zoll™ electrode adapter	Zoll 1200, 1400, 1600, and M-Series
05-10200 CE	AED Philips electrode adapter	Philips CodeMaster 100, XE, XL, XL+ Philips Heartstream/HeartStart XL and XLT Laerdal Heartstart 4000 (Includes: Hewlett-Packard/Agilent branded versions)



M3873A



989803139311

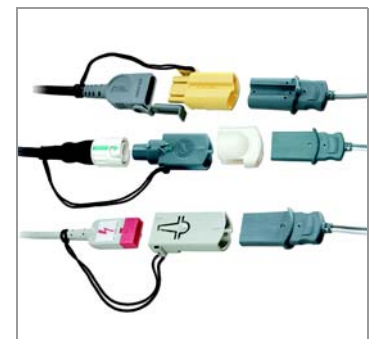

05-10000, 05-10200, 05-10100
Pads Adapters

AED Data Management Solutions

- Helps improve the quality of your response to SCA through retrospective data analysis of previous responses

AED Data Cards and Accessories

Product No.	Description	Philips Instrument
M3524A	FR2 series data card reader for a personal computer.	M3834A (HeartStart Event Review Software) 989803141811 (HeartStart Event Review Organization-wide License) 861276 (HeartStart Event Review Pro Software) 861311 (HeartStart Review Express Connect Software) M3831A, M3833A (CodeRunner Web Software) M3854A (FR2 series data card and tray) M3860A, M3861A, M3840A, M3841A (Heartstream/HeartStart FR2 series AED)
M3853A	FR2 series AED tray for data card (M3854A). Houses FR2 series AED data card when inserted into AED.	
M3854A	FR2 series AED data card and tray. Stores device history and setup data.	M3860A, M3861A, M3840A, M3841A (Heartstream/HeartStart FR2 series AED)
SDCF05	Adapter, Data Card to PCMCIA. Enables the FR2 series data card (M3854A) to be read on a PC that has a PCMCIA format data card reader.	
ACT-IR	Infrared Data Cable for HeartStart AEDs. Enables data collection from HS1 or FRx to PC running Event Review Software.	M5066A, M5067A, M5068A (HeartStart HS1 Defibrillators) 861304, 861305 (HeartStart FRx Defibrillators)

HeartStart Event Review Software

Product No.	Description	Philips Instrument
861276 CE	HeartStart Event Review Pro Software Full featured software that allows you to review and create reports on sudden cardiac arrest event data recorded by Philips defibrillators (English, French, German, Italian, Japanese, Spanish). A01 = Single PC License A02 = 3-PC License A03 = Site License	M3854A, M3524A (FR2 series data card and data card reader) M3500B (Heartstream/HeartStart XLT) M4735A (Heartstream/HeartStart XL)
M3834A CE	HeartStart Event Review Software Software that allows you to review and create reports on sudden cardiac arrest event data recorded by Philips defibrillators (English, French, German, Italian, Japanese, Spanish) for single PC license.	M3535A, M3536A, M3536J (HeartStart MRx, HeartStart MRxE) M3860A, M3861A, M3840A, M3841A (Heartstream/HeartStart FR2 series AED)
9898031 41811	HeartStart Event Review Software Software that allows you to review and create reports on sudden cardiac arrest event data recorded by Philips defibrillators (English, French, German, Italian, Japanese, Spanish) for unlimited PC's in organization.	E, S, EM (Heartstream ForeRunner AED) 940010XX, 940020XX, 940030XX (Heartstart FR AED) 861304, 861305 (HeartStart FRx Defibrillators)
861311 A01	HeartStart Review Express Connect Software Allows you to download defibrillator data, view it, save it, and send to colleagues who have Event Review software via email. (English, French, German, Italian, Japanese, Spanish)	M5066A, M5067A, M5068A (HeartStart HS1 Defibrillators)
9898031 43041 CE	HeartStart Configure-PDA Software Allows you to configure your FRx or HS1 defibrillator (for use by personnel authorized by your medical director). Palm™ and Pocket PC. (English, French, German, Italian, Japanese, Spanish)	M5066A, M5067A, M5068A (HeartStart HS1 Defibrillators)
9898031 43051	HeartStart Case Capture-PDA Software Allows you to download case data from FRx or HS1 without removing AED from service. Palm™ OS. (English, French, German, Italian, Spanish)	861304, 861305 (HeartStart FRx Defibrillator)

AED Cases and Wall Mount Solutions

- Lets you place AEDs strategically and transport them to the patient quickly for fast response to a SCA emergency.

AED Wall Mounts/Accessories

Product No.	Description	Philips Instrument
M3857A	Wall bracket	Wall-mount the AED where it can be deployed quickly during a cardiac emergency. E, S, EM (Heartstream ForeRunner AED) 940010XX, 940020XX, 940030XX (Heartstart FR AED)
M3858A	AED wall sign	Attaches to wall and extends out. Gives high visibility indication of AED location. M3860A, M3861A, M3840A, M3841A (Heartstream/HeartStart FR2 series AED)
M3859A	Secure pull seal for wall mount (10 pack)	Plastic tie used to secure AED to wall mount bracket. Seal deters theft and indicates tampering. 861304, 861305 (HeartStart FRx Defibrillator) M5066A, M5067A, M5068A (HeartStart HS1 Defibrillators)



M3857A

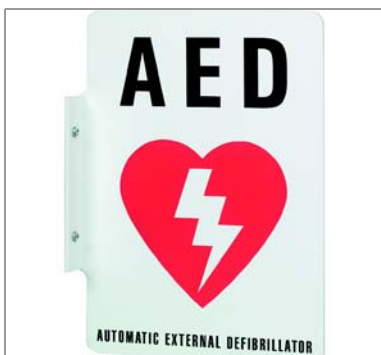

M3858A



M3859A

AED Cases/Wall Cabinets

Product No.	Description	Dimensions	Philips Instrument
M3868A photo next page	Carrying case (red) for FR2 series AED (corduroy fabric).	Dimensions: 11" (W) x 9" (H) x 5" (D)	M3860A, M3861A, M3840A, M3841A (Heartstream/HeartStart FR2 series AED)
M3869A	Carrying case (red) for FR2 series AED (vinyl).	1 lb.	
9898031 36531	Defibrillator Cabinet-Basic. Basic cabinet with audible alarm. Accommodates ForeRunner, FR2 series, HS1, FRx as well as Fast Response Kit.	16.5" (W) x 15" (H) x 6" (D) 11 lbs.	M3860A, M3861A, M3840A, M3841A (Heartstream/HeartStart FR2 series AED) E,S,EM (Heartstream ForeRunner AED)
PFE7023D	AED Cabinet, semi-recessed, with audible alarm and light. Can connect to central security systems.	Inside Dimensions: 14" (W) x 22.5" (H) x 6" (D) 21 lbs.	940010XX, 940020XX, 940030XX (Heartstart FR AED) M5066A, M5067A, M5068A (HeartStart HS1 Defibrillators)
PFE7024D	AED Cabinet, wall surface mounted, with audible alarm and light. Can connect to central security systems.	Dimensions: 16" (W) x 22.5" (H) x 6" (D) 20 lbs.	861304, 861305 (HeartStart FRx Defibrillators)
YC	Carrying case (red), hard plastic waterproof shell.	Dimensions: 12 1/4" (W) x 11 5/8" (H) x 5 3/4" (D) 4 lbs.	M3860A, M3861A, M3840A, M3841A (Heartstream/HeartStart FR2 series AED) 861304, 861305 HeartStart FRx Defibrillators) M5066A, M5067A, M5068A (HeartStart HS1 Defibrillators)
M5075A	Standard carrying case for HeartStart HS1.	9.5" (W) x 8.5" (H) x 4.8" (D) 1.2 lbs.	M5066A, M5067A, M5068A (HeartStart HS1 Defibrillators)
M5076A photo next page	Slim carrying case for HeartStart HS1.	9.5" (W) x 8.5" (H) x 3.5" (D) 1 lb.	
9898031 33171 CE	Temperature Control Carrying Case. Maintains AED at standby temperature in vehicles in extreme cold and hot climates.	15 7/16" (W) x 7 7/16" (H) x 5" (D) 11.2 lbs.	M3860A, M3861A, M3840A, M3841A (Heartstream/HeartStart FR2 series AEDs)
9898031 39251 photo next page	FRx carrying case made of wipeable urethane.	9.5" (W) x 8" (H) x 5" (D)	861304, 861305 (HeartStart FRx Defibrillators)



M3868A



M5076A



9898031 39251

AED Training Materials

- Helps your responders practice delivering care to SCA victims correctly and confidently

Product No.	Description	Quantity	Philips Instrument
07-10900 CE	Reusable AED adult training electrode pads with yellow connector. Non-clinical training and demonstration pads.	1 set	E, S, EM (Heartstream ForeRunner AED when equipped with Training Card) 940010XX, 940020XX, 940030XX (Heartstart FR AED equipped with Training Card) M3860A, M3861A, M3840A, M3841A (Heartstream/HeartStart FR2 series AED equipped with M3864A Training and Administration Pack) M3752A (AED Trainer 2) 07-10801 (AED Trainer)
07-11000	AED Trainer 2 carrying case	1	07-10801 (AED Trainer) M3752A (AED Trainer 2)
M3752A CE	AED Trainer 2. AED trainer that looks and behaves like FR2 series.	1	M3753A, M3754A, 07-10900, M3871A, M3755A, M3756A, 07-11000
M3753A	Remote control for AED Trainer 2	1	M3752A, M3756A (AED Trainer 2, AED Little Anne Training System)
M3754A	Optional programming kit for AED Trainer 2 (includes PC cable with software)	1	M3752A, M3756A (AED Trainer 2, AED Little Anne Training System)
M3755A CE	Training Pads for AED Little Anne. Works with AED Trainer 2 and AED Little Anne manikin to give the student realistic feedback on pads placement.	1	M3756A (AED Little Anne Training System)
M3756A CE	AED Little Anne Training System. All-in-one FR2 Series training solution. Contains AED Trainer 2, remote control, special training pads, and a manikin.	1	M3755A (Training Pads for AED Little Anne)
M3855A CE	Charger for FR2 series AED training and administration pack	1	M3864A (Training and Administration Pack for FR2 Series AEDs)
M3871A CE	HeartStart FR2 series Infant/Child Training Pads	1 set	M3864A, M3752A (Training and Administration Pack for FR2 Series AEDs, AED Trainer 2)

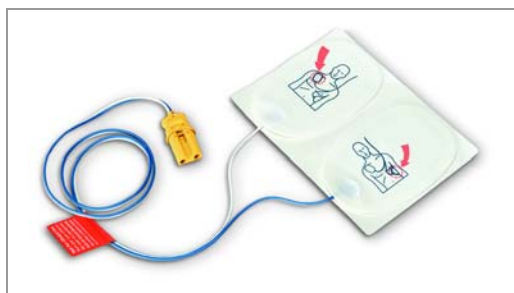

07-10900

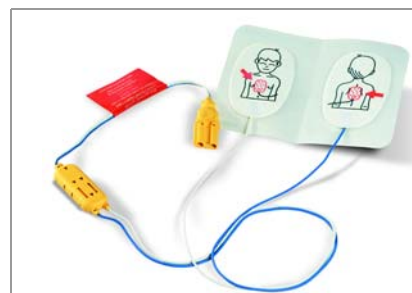

M3871A

AED Training Materials (Continued)

Product No.	Description	Quantity	Philips Instrument
M3860-97800	Quick Reference Card, HeartStart FR2+ (English) Other languages available. Contact your order administrator.	1	M3860A, M3861A, M3840A, M3841A (Heartstream/HeartStart FR2 series AEDs)
M3864A CE	Training and Administration Pack for HeartStart FR2 AED. Allows AED to be configured and used for training without depleting AED battery. Rechargeable.	1	M3860A, M3861A, M3840A, M3841A, (Heartstream/HeartStart FR2 series AEDs) M3855A (Charger for Training and Administration Pack)
M5073A CE	HS1 Adult Training Pads Cartridge and Pad Placement Guide.	1	M5066A, M5067A, M5068A (HeartStart HS1 Defibrillators)
M5074A CE	HS1 Infant/Child Training Pads Cartridge and Pad Placement Guide.	1	M5066A, M5067A, M5068A (HeartStart HS1 Defibrillators)
M5093A CE	HS1 Replacement Adult Training Pads with replaceable seal.	1	M5073A (Adult Training Pads Cartridge and Pad Placement Guide)
M5094A CE	HS1 Replacement Infant/Child Training Pads with replaceable seal.	1	M5074A (Infant/Child Training Pads Cartridge and Pad Placement Guide)
M5066-89100 CE	HS1 Instructor's Training Toolkit NTSC (PAL is M5066-89101).	1	M5066A, M5067A, M5068A (HeartStart HS1 Defibrillators)
9898031 50291	FR2+ Instructor's Training Toolkit NTSC (PAL is 989803150301)	1	M3860A, M3861A, M3840A, M3841A (Heartstream/HeartStart FR2 series AEDs)
M5066-97800 CE	Quick Reference for HeartStart HS1 (English) Other languages available. Contact your order administrator.	1	M5066A, M5067A, M5068A (HeartStart HS1 Defibrillators)
9898031 39271 CE	Training Pads II facilitates training on the HeartStart FRx Defibrillator. Can be used to train for adult and infant/child resuscitation (when used with Infant/Child Key).	1	861304, 861305 (HeartStart FRx Defibrillators)



M3864A



M5073A



M5074A



989803139271

AED Training Materials (Continued)

Product No.	Description	Quantity	Philips AED Instrument
M5085A CE	HeartStart Trainer. Resembles HeartStart HS1 Defibrillator. Provides eight realistic training scenarios and comes with nylon carrying case, one set of Adult Training Pads and one External Manikin Adapter (English).	1	M5066A, M5067A, M5068A (HeartStart HS1 Defibrillators)
M5088A	Internal Manikin Adapter for use with HeartStart Trainer. Compatible with Laerdal ResusciAnne and Little Anne CPR manikins.	1	M5085A (HeartStart Trainer) 861306 (HeartStart FRx Trainer)
M5089A	External Manikin Adapter for use with HeartStart Trainer and all CPR manikins.	5/roll	M5085A (HeartStart Trainer) 861306 (HeartStart FRx Trainer) All CPR manikins
861306	HeartStart FRx Trainer. Resembles HeartStart FRx Defibrillator. Provides eight realistic training scenarios and comes with nylon carrying case, one set of Training Pads II and one External Manikin Adapter. (U.S. English, UK English, French, German)	1	861304, 861305 (HeartStart FRx Defibrillators)



M5085A



861306

Notes



Chapter 13

Cardiac Output

For Information About	See Page
Invasive Cardiac Output	13-2
Non-Invasive Cardiac Output	13-3

Products labeled with a CE mark indicates compliance with the EU Medical Devices Directive.

Invasive Cardiac Output

Product Number	Description	Packaging Information		Use with Philips Instrument
14455A CE	Styrofoam ice bucket for chilling injectate solution.	1 pack = 4 buckets	Pkg. wt. = 3lb 9oz (1.62kg)	N/A
15244A CE	Remote start handswitch and cable.	1 pack = 1 each	Pkg wt=1oz (28g)	M1012A with M1641A M1642A M3012A

Product Number	Description	Packaging Information		Use with Philips Instrument
23001A CE	Reusable injectate temperature probe to measure cardiac output. For use with Baxter CO-Set™ kit only.	Length (including probe) = 7'9" (2.4m)	1 box = 1 probe	Pkg. wt. = 3oz (85g)
23001B CE		Length (including probe) = 1'9" (0.5m)		Pkg. wt. = 2oz (57g)
23002A CE	Reusable ice bath temperature probe. Tubular stainless steel. Measures temperature of ice bath and syringes.	Length (including probe) = 10' (3m)		Pkg. wt. = 3oz (85g)
M1642A CE	Cardiac output cable for use with the Philips cardiac output modules.	Length = 9' (2.7m)	1 pack = 1 cable	Pkg. wt. = 8oz (227g)
M1643A CE	Cardiac output cable for use with pulse contour analysis and transpulmonary thermodilution.	Length = 15.75' (4.8m)	1 pack = 1 cable	Pkg. wt. = 10.5oz (297g)
M1646A CE	PICCO temperature probe to measure cardiac output. Not available in N. America or Japan	Length = 4.9' (1.5m)	1 pack = 1 probe	Pkg. wt. = 3oz (85g)



23001A



23002A

Non-Invasive Cardiac Output

Philips ICG (Impedance Cardiography) Cable

Product Number	Description	Packaging	Use with Philips Instrument
M4620A CE	One piece grabber cable. Length = 7'11" to 9'2" (2-3m)	1 pack = 1 each	862146 ICG Hemodynamic Monitor
M4608A CE	ICG Disposable Sensor (Shelf life: at least 8 months)	4 sensors per pack 10 packs = 1 box	

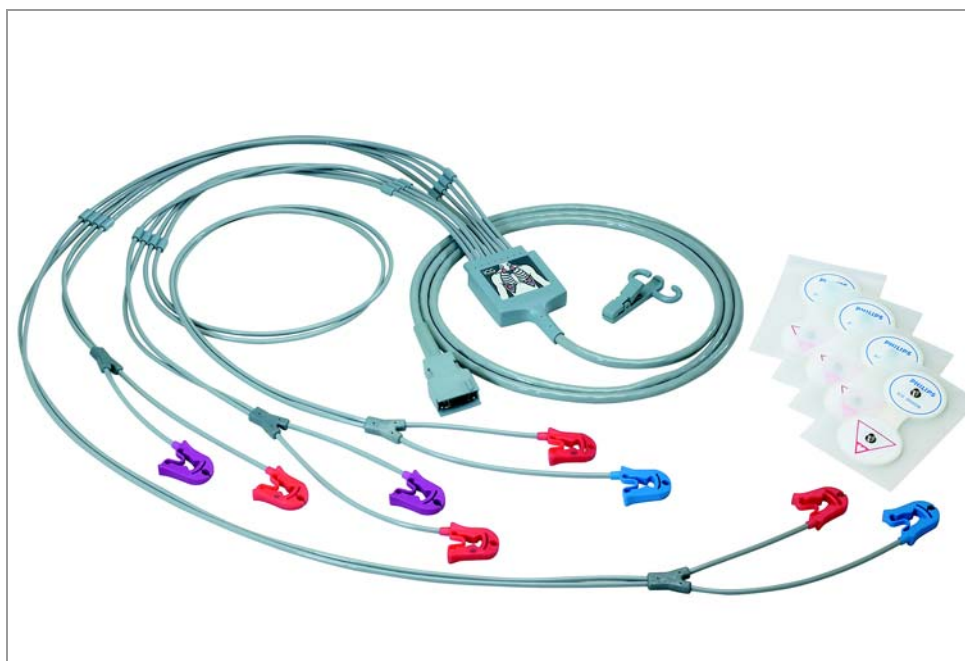

M4620A cable with Philips M4608A ICG Sensors

Notes

Appendix A

For Information About	See Page
Supplies for Philips (HP/Agilent) branded instruments	A-2
Index by Product Number	A-33

14360A (obsolete)
CO₂ Transducer

Gas Monitoring Supplies

14363A	Reusable pediatric airway adapter
M1460A	CO ₂ sensor
M1465A	Reusable standard airway adapter

15205A (obsolete)
Transcutaneous Transducer

15206A (obsolete)
Transcutaneous O₂ Transducer

Gas Monitoring Supplies

15210-60010	CAL 1 gas cylinder for TcPO ₂
15210-60020	CAL 2 gas cylinder for TcPO ₂
15210-64010	CAL 1 gas cylinder
15210-64020	CAL 2 gas cylinder

15207A (obsolete)
Transcutaneous O₂ Transducer

Gas Monitoring Supplies

15209-60020	Fixation kit for 15207/9A transducers
-------------	---------------------------------------

15209A (obsolete)
Transcutaneous O₂/CO₂ Transducer

15209AH (obsolete)
Accessory Kit for 15209A

Gas Monitoring Supplies

15209-60010	Accessory kit for 15209A transducer
15209-60020	Fixation kit for 15207/9A transducers
15210-60010	CAL 1 gas cylinder for TcPO ₂
15210-60020	CAL 2 gas cylinder for TcPO ₂
15210-64010	CAL 1 gas cylinder
15210-64020	CAL 2 gas cylinder

15210A (obsolete) TcPO₂ Calibration Unit

Gas Monitoring Supplies

15210-60010	CAL 1 gas cylinder for TcPO ₂
15210-60020	CAL 2 gas cylinder for TcPO ₂
15210-64010	CAL 1 gas cylinder
15210-64020	CAL 2 gas cylinder

15210AH (obsolete)
CO₂ Calibration Gas Cylinder Set

Gas Monitoring Supplies

15210-60010	CAL 1 gas cylinder for TcPO ₂
15210-60020	CAL 2 gas cylinder for TcPO ₂
15210-64010	CAL 1 gas cylinder
15210-64020	CAL 2 gas cylinder

15210B (active)
TcPO₂ Calibration Unit

Gas Monitoring Supplies

15210-60010	CAL 1 gas cylinder for TcPO ₂
15210-64010	CAL 1 gas cylinder
M2205A	Cal tubes

280-A01 (obsolete)
Rappaport-Sprague Stethoscope - 14 inch hoses

280-A02 (obsolete)
Stethoscope - 18 inch hoses

Stethoscope Replacement Parts Kits

280-100-C25	Small eartip, 2 pair/package
280-100-C26	Large eartip, 2 pair/package
280-100-C27	Adult Chest Piece Kit containing: 1 large adult diaphragm 1 large adult bell 1 small adult bell
280-100-0	18" Standard Reconditioning Kit: 1 binaural spring 1 hose clip 2 plastic sleeves
280-100-1	24" Standard Reconditioning Kit: 1 binaural spring 1 hose clip 2 plastic sleeves

77025A (obsolete)
Sonos 500 Ultrasound System

77030A (obsolete)
Sonos 1000 Ultrasound System

77035A (obsolete)
Sonos 1500 Ultrasound System

Ultrasound Monitoring Supplies

13920B	1/2" VHS cassette tape
13921B	1/2" Super VHS cassette tape
40483A	Aquasonic transmission gel, 12/8oz. bottles
40483B	Aquasonic transmission gel, 5 liter

ECG Safety Trunk Cables

M1580A	ECG 3-ld safety connector trunk cable, AAMI
M1590A	ECG 3-ld safety connector trunk cable, IEC

ECG Safety Cable Lead Sets

M1603A	Shielded 3-lead set, grabber, safety, AAMI
M1609A	Pediatric, non-shielded 3-lead set, AAMI
M1613A	Shielded 3-lead set, grabber, safety, IEC
M1619A	Pediatric, non-shielded 3-lead set, IEC

ECG Safety Replacement Leads

(See Cable section of the Medical Supplies Reference Guide for detailed listing).

ECG Safety Cable Accessories

M1501A	Combiner for 3-lead sets
M1503A	Organizer for shielded 3-lead sets
M1509A	Bedsheet clip, repositionable
M2281A	Patient cable organizer

Paper

40479A	Ultrasound strip chart recorder paper
--------	---------------------------------------

Electrodes

(See Electrode section of the Medical Supplies Reference Guide for detailed listing)

Thermal Strip Chart Recorder**Paper**

40479A	Ultrasound strip chart recorder paper
--------	---------------------------------------

**77570A/B (obsolete)
Video Copy Processor****Paper**

40458A	Plasticized imaging paper, 77570A recorder
--------	--

**78100A (obsolete)
ECG Telemetry Transmitter****Telemetry Supplies**

40455A	Zinc-air battery
9300-0768-050	Disposable telemetry pouches
9300-0768-200	Disposable telemetry pouches

**78173A/W (obsolete)
1-Channel Recorder****Paper**

40453A	1-ch chem/therm paper, 40mm grid, 10 rolls
--------	--

**78204B (obsolete)
Temperature Module****78204C (obsolete)
Temperature Module****Disposable Temperature Probes**

21090A	Disposable general purpose temp probe
21091A	Disposable skin surface temperature probe
21093A	Disposable esophageal/stethoscope temp probe, 12 Fr
21094A	Disposable esophageal/stethoscope temp probe, 18 Fr
21095A	Disposable esophageal/stethoscope temp probe, 24 Fr
21096A	Disposable Foley Catheter temp probe, 16 Fr
21097A	Disposable Foley Catheter temp probe, 18 Fr
M1837A	Disposable Foley Catheter temp probe, 9 Fr
M2255A	Disposable Foley Catheter temp probe, 14 Fr

**78214A (obsolete)
Temperature Module****Disposable Temperature Probes**

21090A	Disposable general purpose temp probe, 12 Fr
21091A	Disposable skin surface temp probe
21093A	Disposable esophageal stethoscope temp probe, 12 Fr
21094A	Disposable esophageal stethoscope temp probe, 18 Fr
21095A	Disposable esophageal stethoscope temp probe, 24 Fr
21096A	Disposable Foley Catheter temp probe, 16 Fr
21097A	Disposable Foley Catheter temp probe, 18 Fr
M1837A	Disposable general purpose temp probe, 9 Fr
M2255A	Disposable Foley Catheter temp probe, 14 Fr

78214C (obsolete) Differential Temperature Module

Disposable Temperature Probes

21090A	Disposable general purpose temp probe, 12Fr
21091A	Disposable skin surface temp probe
21093A	Disposable esophageal stethoscope temp probe, 12 Fr
21094A	Disposable esophageal stethoscope temp probe, 18 Fr
21095A	Disposable esophageal stethoscope temp probe, 24 Fr
21096A	Disposable Foley Catheter temp probe, 16 Fr
21097A	Disposable Foley Catheter temp probe, 18 Fr
M1837A	Disposable general purpose temp probe, 9 Fr
M2255A	Disposable Foley Catheter temp probe, 14 Fr

78231D (obsolete) Cardiac Output Module

Cardiac Output Supplies

14455A	Ice bucket for cardiac output, styrofoam
--------	--

Reusable Temperature Probes

23001A/B	CO-Set reusable injectate temp probe
23002A	Ice bath reusable static temp probe

78352A / 78352C (obsolete) Adult Bedside Monitor

Reusable Pressure Cuffs

40400A	Reusable pressure cuff kit, 3 cuffs, 40401B/C/D
40400B	Reusable pressure cuff kit, 5 cuffs 40401A/B/C/D/E
40401A	Reusable infant size cuff
40401B	Reusable pediatric size cuff
40401C	Reusable adult size cuff
40401D	Reusable large arm size cuff
40401E	Reusable thigh size cuff
M1571A	Reusable pressure cuff, infant
M1572A	Reusable pressure cuff, pediatric
M1573A	Reusable pressure cuff, small adult
M1574A	Reusable pressure cuff, adult size
M1575A	Reusable pressure cuff, large adult
M1576A	Reusable pressure cuff, thigh
M1577A	Reusable (long life) pressure cuff kit, 4 smaller cuffs (M1571A, 72A, 73A, 74A)
M1578A	Reusable (long life) pressure cuff kit, 4 larger cuffs (M1573A, 74A, 75A, 76A)
M1579A	Reusable (long life) pressure cuff kit, (M1571A, 72A, 73A, 74A, 75A, 76A)

Disposable Pressure Cuffs (non-sterile)

M1874A	Disposable cuff, infant size
M1875A	Disposable cuff, pediatric size
M1876A	Disposable cuff, small adult size
M1877A	Disposable cuff, adult size
M1878A	Disposable cuff, large adult size
M1879A	Disposable cuff, thigh size

Pressure Cuff Interconnect Tubing

M1598B	Interconnect tubing for all adult and pediatric cuffs, 4.92' (1.5m) length
M1599B	Interconnect tubing for all adult and pediatric cuffs, 9.84' (3.0m) length

Disposable Temperature Probes

21082A/B	Phone plug ext. cable for disp temp probe
21090A	Disposable general purpose temp probe, 12Fr
21091A	Disposable skin surface temp probe
21093A	Disposable esophageal stethoscope temp probe, 12 Fr
21094A	Disposable esophageal stethoscope temp probe, 18 Fr
21095A	Disposable esophageal stethoscope temp probe, 24 Fr
21096A	Disposable Foley Catheter temp probe, 16 Fr
21097A	Disposable Foley Catheter temp probe, 18 Fr
M1837A	Disposable general purpose temp probe, 9 Fr
M2255A	Disposable Foley Catheter temp probe, 14 Fr

Reusable Temperature Probes

21075A	General purpose temp probe
21076A	Small temp probe, flexible
21078A	Skin surface temp probe, tape-on

ECG Safety Trunk Cables

M1580A, M1500A	ECG 3-ld safety connector trunk cable, AAMI
M1590A, M1510A	ECG 3-ld safety connector trunk cable, IEC
M1600A	ECG 5-ld safety connector trunk cable, AAMI
M1610A	ECG 5-ld safety connector trunk cable, IEC

ECG Safety Cable Lead Sets

M1601A	OR 3-lead set, grabber, safety, AAMI
M1603A	Shielded 3-lead set, grabber, safety, AAMI
M1605A	Shielded 3-lead set, snap, safety, AAMI
M1611A	OR 3-lead set, grabber, safety, IEC
M1613A	Shielded 3-lead set, grabber, safety, IEC
M1615A	Shielded 3-lead set, snap, safety, IEC
M1621A	OR 5-lead set, grabber, safety, AAMI
M1623A	Shielded 5-lead set, grabber, safety, AAMI
M1625A	Shielded 5-lead set, snap, safety, AAMI
M1631A	OR 5-lead set, grabber, safety, IEC
M1633A	Shielded 5-lead set, grabber, safety, IEC
M1635A	Shielded 5-lead set, snap, safety, IEC

ECG Safety Cable Replacement Leads

(See Cable section of the Medical Supplies Reference Guide for detailed listing.)

ECG Safety Cable Accessories

M1501A	Combiner for 3-lead sets
M1502A	Combiner for 5-lead sets
M1503A	Organizer for shielded 3-lead sets
M1504A	Organizer for shielded 5-lead sets
M1509A	Bedsheet clip, repositionable
M2281A	Patient cable organizer

SpO₂ Sensors

M1191A	Reusable adult finger sensor, use with M1940A adapter cable
M1192A	Reusable pediatric or small adult finger sensor, use with M1940A adapter cable
M1193A	Reusable neonatal foot/hand sensor, use with M1940A adapter cable
M1194A	Reusable pediatric/adult ear sensor, use with M1940A adapter cable
M1195A	Reusable infant finger sensor, use with M1940A adapter cable
M1627A	Velcro straps for M1191A sensors
M1940A	Adapter cable for M1191A, M1192A, M1193A, M1194A, M1195A sensors
M1900B	Connector cable for SpO ₂ sensors
M1901B*	Disposable SpO ₂ sensor for neonatal foot Europe and Japan only
M1902B*	Disposable SpO ₂ sensor for infant digit, for Europe and Japan only
M1903B*	Disposable SpO ₂ sensor for pediatric digit for Europe and Japan only
M1904B*	Disposable SpO ₂ sensor for adult digit for Europe and Japan only
M1940A	Adapter cable, requires Release E software/updated software

* Note: sold outside of U.S. only

Electrodes

(See Electrode section of the Medical Supplies Reference Guide for detailed listing.)

**78354A (obsolete)
Patient Monitor****Reusable Pressure Cuffs**

40400A	Reusable pressure cuff kit, 3 cuffs, (40401B/C/D)
40400B	Reusable pressure cuff kit, 5 cuffs, 40401A/B/C/D/E
40401A	Reusable infant size cuff
40401B	Reusable pediatric size cuff
40401C	Reusable adult size cuff
40401D	Reusable large arm size cuff
40401E	Reusable thigh size cuff
M1571A	Reusable (long life) pressure cuff, infant
M1572A	Reusable (long life) pressure cuff, pediatric
M1573A	Reusable (long life) pressure cuff, small adult
M1574A	Reusable (long life) pressure cuff, adult
M1575A	Reusable (long life) pressure cuff, large adult

M1576A	Reusable (long life) pressure cuff, thigh
M1577A	Reusable (long life) pressure cuff kit, 4 smaller cuffs (M1571A, 72A, 73A, 74A)
M1578A	Reusable (long life) pressure cuff kit, 4 larger cuffs (M1573A, 74A, 75A, 76A)
M1579A	Reusable (long life) pressure cuff kit, (M1571A, 72A, 73A, 74A, 75A, 76A)

Disposable Pressure Cuffs (non-sterile)

M1874A	Disposable cuff, infant size
M1875A	Disposable cuff, pediatric size
M1876A	Disposable cuff, small adult size
M1877A	Disposable cuff, adult size
M1878A	Disposable cuff, large adult size
M1879A	Disposable cuff, thigh size

Pressure Cuff Interconnect Tubing

M1598B	Interconnect tubing for all adult & pediatric cuffs, 4.92' (1.5m) length
M1599B	Interconnect tubing for all adult & pediatric cuffs, 9.84' (3.0m) length

Gas Monitoring Supplies

14363A	Reusable pediatric airway adapter
M1460A	CO ₂ sensor, use with M1465A
M1465A	Reusable standard airway adapter

Disposable Temperature Probes

21082A/B	Phone plug ext. cable for disp temp probe
21090A	Disposable general purpose temp probe, 12Fr
21091A	Disposable skin surface temperature probe
21093A	Disposable esophageal stethoscope temp probe, 12 Fr
21094A	Disposable esophageal stethoscope temp probe, 18 Fr
21095A	Disposable esophageal stethoscope temp probe, 24 Fr
21096A	Disposable Foley Catheter temp probe, 16 Fr
21097A	Disposable Foley Catheter temp probe, 18 Fr
M1837A	Disposable general purpose temp probe, 9 Fr
M2255A	Disposable Foley Catheter temp probe, 14 Fr

Reusable Temperature Probes

21075A	General purpose temp probe
21076A	Small temp probe, flexible
21078A	Skin surface temp probe, tape-on

ECG Safety Trunk Cables

M1580A	ECG 3-ld safety connector trunk cable, AAMI
M1590A	ECG 3-ld safety connector trunk cable, IEC
M1600A	ECG 5-ld safety connector trunk cable, AAMI
M1610A	ECG 5-ld safety connector trunk cable, IEC

ECG Safety Cable Lead Sets

M1601A	OR 3-lead set, grabber, safety, AAMI
--------	--------------------------------------

M1603A	Shielded 3-lead set, grabber, safety, AAMI
M1605A	Shielded 3-lead set, snap, safety, AAMI
M1611A	OR 3-lead set, grabber, safety, IEC
M1613A	Shielded 3-lead set, grabber, safety, IEC
M1615A	Shielded 3-lead set, snap, safety, IEC
M1621A	OR 5-lead set, grabber, safety, AAMI
M1623A	Shielded 5-lead set, grabber, safety, AAMI
M1625A	Shielded 5-lead set, snap, safety, AAMI
M1631A	OR 5-lead set, grabber, safety, IEC
M1633A	Shielded 5-lead set, grabber, safety, IEC
M1635A	Shielded 5-lead set, snap, safety, IEC

ECG Safety Cable Accessories

M1501A	Combiner for 3-lead sets, 3/pack
M1502A	Combiner for 5-lead sets, 3/pack
M1503A	Organizer for shielded 3-lead sets
M1504A	Organizer for shielded 5-lead sets
M1509A	Bedsheet clip, repositionable
M2281A	Patient cable organizer

SpO₂ Sensors

(See Chapter 9 for instrument compatibility)

Electrodes

(See Electrode section of the Medical Supplies Reference Guide for detailed listing)

78354C (obsolete) Patient Monitor

Reusable Pressure Cuffs

40400A	Reusable pressure cuff kit, 3 cuffs, (40401B/C/D)
40400B	Reusable pressure cuff kit, 5 cuffs, (40401A/B/C/D/E)
40401A	Reusable infant size cuff
40401B	Reusable pediatric size cuff
40401C	Reusable adult size cuff
40401D	Reusable large arm size cuff
40401E	Reusable thigh size cuff
M1571A	Reusable cuff, infant size
M1572A	Reusable cuff, pediatric
M1573A	Reusable cuff, small adult
M1574A	Reusable cuff, adult
M1575A	Reusable cuff, large adult
M1576A	Reusable cuff, thigh
M1577A	Reusable cuff kit, 4 smaller cuffs (M1571A, 72A, 73A, 74A)
M1578A	Reusable (long life) pressure cuff kit, 4 larger cuffs (M1573A, 74A, 75A, 76A)
M1579A	Reusable (long life) pressure cuff kit, (M1571A, 72A, 73A, 74A, 75A, 76A)

Disposable Pressure Cuffs (non-sterile)

M1874A	Disposable cuff, infant size
M1875A	Disposable cuff, pediatric size
M1876A	Disposable cuff, small adult size
M1877A	Disposable cuff, adult size
M1878A	Disposable cuff, large adult size
M1879A	Disposable cuff, thigh size

Pressure Cuff Interconnect Tubing

M1598B	Interconnect tubing for all adult & pediatric cuffs, 4.92' (1.5m) length
M1599B	Interconnect tubing for all adult & pediatric cuffs, 9.84' (3.0m) length

Gas Monitoring Supplies

14363A	Reusable pediatric airway adapter
M1460A	CO ₂ sensor, use with M1465A
M1465A	Reusable standard airway adapter

Disposable Temperature Probes

21082A/B	2-pin plug extension cable
21090A	Disposable general purpose temp probe, 12Fr
21091A	Disposable skin surface temp probe
21093A	Disposable esophageal stethoscope temp probe, 12 Fr
21094A	Disposable esophageal stethoscope temp probe, 18 Fr
21095A	Disposable esophageal stethoscope temp probe, 24 Fr
21096A	Disposable Foley Catheter temp probe, 16 Fr
21097A	Disposable Foley Catheter temp probe, 18 Fr
M1837A	Disposable general purpose temp probe, 9 Fr
M2255A	Disposable Foley Catheter temp probe, 14 Fr

Reusable Temperature Probes

21075A	General purpose temp probe
21076A	Small temp probe, flexible
21078A	Skin surface temp probe, tape-on

ECG Safety Trunk Cables (12 pin input connector)

M1669A	ECG 3-ld safety connector trunk cable, AAMI/IEC
M1668A	ECG 5-ld safety connector trunk cable, AAMI/IEC

ECG Safety Cable Lead Sets

M1675A	OR 3-lead set, grabber, AAMI
M1671A	Shielded 3-lead set, grabber, safety, AAMI
M1673A	Shielded 3-lead set, snap, safety, AAMI
M1622A	Unshielded 3-lead set, safety, AAMI
M1624A	Unshielded 3-lead set, safety, AAMI
M1678A	OR 3-lead set, grabber, safety, IEC
M1672A	Shielded 3-lead set, grabber, safety, IEC
M1674A	Shielded 3-lead set, snap, safety, IEC
M1626A	Unshielded 3-lead set, safety, IEC
M1621A	Shielded OR 5-lead grabber, safety, AAMI
M1968A	Shielded 5-lead set, grabber, safety, AAMI
M1644A	Shielded 5-lead set snap, safety, AAMI
M1647A	Unshielded 5-lead set, safety, AAMI
M1974A	Shielded OR 5-lead set, grabber, safety, IEC
M1971A	Shielded 5-lead set, grabber, safety, IEC
M1645A	Shielded 5-lead set snap, safety, IEC
M1648A	Unshielded 5-lead set, safety, IEC

ECG Safety Cable Accessories

M1501A	Combiner for 3-lead sets
M1502A	Combiner for 5-lead sets

M1503A	Organizer for shielded 3-lead sets
M1504A	Organizer for shielded 5-lead sets
M1509A	Bedsheet clip, repositionable
M2281A	Patient cable organizer

SpO₂ Sensors

M1191A	Reusable adult finger sensor, use with M1940A adapter cable
M1192A	Reusable pediatric or small adult finger sensor, use with M1940A adapter cable
M1193A	Reusable neonatal foot/hand sensor, use with M1940A adapter cable
M1194A	Reusable pediatric/adult ear sensor, use with M1940A adapter cable
M1195A	Reusable infant finger sensor, use with M1940A adapter cable
M1900B	Connector cable for SpO ₂ sensors
M1901B*	Disposable SpO ₂ sensor for neonatal foot Europe and Japan only
M1902B*	Disposable SpO ₂ sensor for infant digit, for Europe and Japan only
M1903B*	Disposable SpO ₂ sensor for pediatric digit for Europe and Japan only
M1904B*	Disposable SpO ₂ sensor for adult digit for Europe and Japan only
M1627A	Velcro straps for M1191A sensors
M1940A	Adapter cable

* Note: Sold outside U.S. only

Electrodes

(See Electrode section of the Medical Supplies Reference Guide for detailed listing.)

78356A (obsolete) Gas Monitor

Gas Monitoring Supplies

14363A	Reusable pediatric airway adapter
M1460A	CO ₂ sensor, use with M1465Ar
M1465A	Reusable standard airway adapter

78552B (obsolete) Signal Acquisition Module

Cardiac Output Supplies

14455A	Ice bucket for cardiac output, styrofoam
--------	--

Reusable Temperature Probes

23001A/B	CO-Set injectate temp probe
23002A	Ice bath temp probe

78556A (obsolete) CO₂ Module

Gas Monitoring Supplies

14363A	Reusable pediatric airway adapter
--------	-----------------------------------

M1460A	CO ₂ sensor, use with M1465A
M1465A	Reusable standard airway adapter

78560A (obsolete) Central Monitor

Paper (original recorder)

40457C	1-ch chem/therm paper, 10 rolls/case
40457D	1-ch chem/therm paper, 80 rolls/case
40469A	Multi-channel therm paper, Z-fold, use with M1117A recorder

Paper (upgraded recorder)

40477A	Unprinted chem/therm paper, 10 rls
40477B	Unprinted chem/therm paper, 80 rls

78834C (obsolete) Neonatal Bedside Monitor

Pressure Cuffs (non-sterile)

M1866A	Disposable neonatal cuff, sz 1
M1868A	Disposable neonatal cuff, sz 2
M1870A	Disposable neonatal cuff, sz 3
M1872A	Disposable neonatal cuff, sz 4

Pressure Cuff Interconnect Tubing

M1596B	Interconnect tubing for neonatal cuffs, 4.92' (1.5m) length
M1597B	Interconnect tubing for neonatal cuffs, 9.84' (3.0m) length

Disposable Temperature Probes

21082A/B	2-pin plug extension cable
21091A	Disposable skin surface temp probe
M1837A	Disposable general purpose temp probe, 9 Fr

Reusable Temperature Probes

21076A	Small temp probe, flexible, reusable
21078A	Skin surface temp probe, tape-on

ECG Safety Trunk Cables (12 pin input connector)

M1669A	ECG 3-ld safety connector trunk cable, AAMI/IEC
M1668A	ECG 5-ld safety connector trunk cable, AAMI/IEC

ECG Safety Cable Lead Sets

M1622A	Unshielded 3-lead set, safety, AAMI
M1624A	Unshielded 3-lead set, safety, AAMI
M1647A	Unshielded 5-lead set, safety, AAMI
M1648A	Unshielded 5-lead set, safety, IEC

ECG Safety Cable Accessories

M1501A	Combiner for 3-lead sets, 3/pack
M1509A	Bedsheet clip, repositionable, 3/pack
M2281A	Patient cable organizer, 8/pack

SpO₂ Accessories

M1193A	Reusable neonatal foot/hand sensor,
--------	-------------------------------------

M1900B	use with M1940A adapter cable
M1901B*	Connector cable for SpO ₂ sensors Disposable SpO ₂ sensor for neonatal foot (Eur/Japan only)
M1902B*	Disposable SpO ₂ sensor for infant digit (Eur/Japan only)
M1903B*	Disposable SpO ₂ sensor for pediatric digit (Eur/Japan only)
M1904B*	Disposable SpO ₂ sensor for Adult digit (Eur/Japan only)

*Note: Sold outside U.S. only

Gas Monitoring

14363A Neonatal airway adapter

Electrodes

See Electrode section of the Medical Supplies Reference Guide for detailed listing.)

8020A (obsolete) Fetal Monitor

Paper

9270-0484	2-ch chem/therm, FHR 50-210, green grid
9270-0630-050	2-ch chem/therm, FHR, kPa scale, 50-210, green grid

80201A (obsolete) Obstetrical Telemetry System

Fetal Scalp Electrodes

15133E	Disposable fetal scalp electrode, single spiral
15133D	Disposable fetal scalp electrode, double spiral, for Europe only
15240A	Direct ECG cable for fetal scalp electrode
M1347A	DECG adapter
M1349A	Disposable fetal adhesive pad electrode
M1362B	DECG legplate adapter cable

8021A (obsolete) Fetal Monitor

Paper

9270-0484	2-ch chem/therm, FHR 50-210,
-----------	------------------------------

9270-0630-050	green grid 2-ch chem/therm, FHR, kPa scale, 50-210, green grid
---------------	--

80240A (obsolete) Fetal Ultrasound Telemetry

Ultrasound Monitoring Supplies

40483A	Aquasonic transmission gel, 12/8oz. bottles
40483B	Aquasonic transmission gel, 5 liter

Fetal Belts: see chapter 4

8025A/B (obsolete) Fetal Monitor

Paper

9270-0484	2-ch chem/therm, FHR 50-210, green grid
9270-0630-050	2-ch chem/therm, FHR, kPa scale, 50-210, green grid

8030A (obsolete) Fetal Monitor

Ultrasound Monitoring Supplies

40483A	Aquasonic transmission gel, 12/8oz. bottles
40483B	Aquasonic transmission gel, 5 liter

Fetal Scalp Electrodes

15133E	Disposable fetal scalp electrode, single spiral
15133D	Disposable fetal scalp electrode, double spiral, for Europe only
15240A	Direct ECG cable for fetal scalp electrode
M1347A	DECG adapter
M1349A	Disposable fetal adhesive pad electrode
M1362B	DECG legplate adapter cable

Fetal Belts: see chapter 4

Paper

9270-0484	2-ch chem/therm, FHR 50-210, green grid
9270-0630-050	2-ch chem/therm, FHR, kPa scale, 50-210, green grid

8031A (obsolete) Fetal Monitor

Ultrasound Monitoring Supplies

40483A	Aquasonic transmission gel, 12/8oz. bottles
40483B	Aquasonic transmission gel, 5 liter

Paper

9270-0484	2-ch chem/therm, FHR 50-210, green grid
9270-0630-050	2-ch chem/therm, FHR, kPa scale, 50-210, green grid

Fetal Belts: see chapter 4

8032A (obsolete) Fetal Central Station Recorder

Ultrasound Monitoring Supplies

40483A	Aquasonic transmission gel, 12/8oz. bottles
40483B	Aquasonic transmission gel, 5 liter

Paper

9270-0484	2-ch chem/therm, FHR 50-210, green grid
9270-0630-050	2-ch chem/therm, FHR, kPa scale, 50-210, green grid

8040A (obsolete) Fetal Monitor

Ultrasound Monitoring Supplies

40483A	Aquasonic transmission gel, 12/8oz. bottles
40483B	Aquasonic transmission gel, 5 liter

Fetal Scalp Electrodes

15133E	Disposable fetal scalp electrode, single spiral
15133D	Disposable fetal scalp electrode, double spiral, for Europe only
15240A	Direct ECG cable for fetal scalp electrode
M1347A	DECG adapter
M1349A	Disposable fetal adhesive pad electrode
M1362B	DECG legplate adapter cable

Fetal Belts: see chapter 4

Intrauterine Pressure (IUP) Products

M1333A	Disposable sensor-tip IUP catheter, internal diaphragm
M1334A	Reusable connector cable for M1333A
M1348A	Reusable connector cable for M1333A

Paper

9270-0484	2-ch chem/therm, FHR 50-210, green grid
9270-0630-050	2-ch chem/therm, FHR, kPa scale, 50-210, green grid

8041A (obsolete) Fetal Monitor

Ultrasound Monitoring Supplies

40483A	Aquasonic transmission gel, 12/8oz. bottles
40483B	Aquasonic transmission gel, 5 liter

Fetal Belts: see chapter 4

Paper

9270-0484	2-ch chem/therm, FHR 50-210, green grid
9270-0630-050	2-ch chem/therm, FHR, kPa scale, 50-210, green grid

8232A/B (obsolete) NeoTrend Recorder

Paper

9270-0484	2-ch chem/therm, FHR 50-210, green grid
-----------	---

M1001A (obsolete) ECG Module

M1001B (active) ECG Chan. Parameter Module

M1002A (obsolete) ECG/Respiration Module

M1002B (active) ECG/Respirator Module

ECG Safety Trunk Cables (12 pin input connector)

M1669A	ECG 3-ld safety connector trunk cable, AAMI/IEC
M1668A	ECG 5-ld safety connector trunk cable, AAMI/IEC

ECG Safety Cable Lead Sets

M1675A	OR 3-lead set, grabber, AAMI
M1671A	Shielded 3-lead set, grabber, safety, AAMI
M1673A	Shielded 3-lead set, snap, safety, AAMI
M1622A	Unshielded 3-lead set, safety, AAMI
M1624A	Unshielded 3-lead set, safety, AAMI
M1678A	OR 3-lead set, grabber, safety, IEC
M1672A	Shielded 3-lead set, grabber, safety, IEC
M1674A	Shielded 3-lead set, snap, safety, IEC
M1626A	Unshielded 3-lead set, safety, IEC

M1621A	Shielded OR 5-lead grabber,safety, AAMI
M1968A	Shielded 5-lead set, grabber, safety, AAMI
M1644A	Shielded 5-lead set snap, safety, AAMI
M1647A	Unshielded 5-lead set, safety, AAMI
M1974A	Shielded OR 5-lead set, grabber, safety, IEC
M1971A	Shielded 5-lead set, grabber, safety, IEC
M1645A	Shielded 5-lead set snap, safety, IEC
M1648A	Unshielded 5-lead set, safety, IEC

ECG Safety Cable Accessories

M1501A	Combiner for 3-lead sets, 3/pack
M1502A	Combiner for 5-lead sets, 3/pack
M1503A	Organizer for shielded 3-lead sets
M1504A	Organizer for shielded 5-lead sets
M1509A	Bedsheet clip, repositionable, 3/pack
M2281A	Patient cable organizer, 8/pack

Electrodes

(See Electrode section of the Medical Supplies Reference Guide for detailed listing.)

M1006A (obsolete)

M1006B (active)

Invasive Blood Pressure Module

Transducers

CPJ840J6	Memscap Pressure Transducer
----------	-----------------------------

Pressure Domes

CPJ84022	Memscap single use sterile domes, pk of 50
----------	--

Pressure Accessories

M1567A	Single Line Blood Pressure kit (IEC)
M1568A	Dual Line Blood Pressure kit I(IEC)
M1634A	Adapter Cable
M2271A	Holder for DPT (requires M2272A)
M2272A	IV Pole Mount
M1634A	Reusable Adapter Cable for M1567A & M1568A
CPJ8447	Memscap IV Pole Mount
CPJ84046	Memscap Transducer Holder

M1008A (obsolete)

NIBP Module

Reusable Pressure Cuffs

M1571A	Reusable pressure cuff, infant
M1572A	Reusable pressure cuff, pediatric
M1573A	Reusable pressure cuff, small adult
M1574A	Reusable pressure cuff, adult
M1575A	Reusable pressure cuff, large adult
M1576A	Reusable pressure cuff, thigh
M1577A	Reusable pressure cuff kit, 4 smaller cuffs (M1571A, 72A, 73A,74A)
M1578A	Reusable pressure cuff kit, 4 larger cuffs (M1573A, 74A, 75A, 76A)
M1579A	Reusable pressure cuff kit, (M1571A, 72A, 73A, 74A, 75A, 76A)

M4552B	Antimicrobial reusable cuff, infant
M4553B	Antimicrobial reusable, pediatric
M4554B	Antimicrobial reusable, sm adult
M4555B	Antimicrobial reusable, adult
M4556B	Antimicrobial reusable, adult x-long
M4557B	Antimicrobial reusable, lg adult
M4558B	Antimicrobial lg adult, x-long
M4559B	Antimicrobial reusable, thigh

Disposable Pressure Cuffs (non-sterile)

M1874A	Disposable cuff, infant size
M1875A	Disposable cuff, pediatric size
M1876A	Disposable cuff, small adult size
M1877A	Disposable cuff, adult size
M1878A	Disposable cuff, large adult size
M1879A	Disposable cuff, thigh size
M4572B	Soft Disposable, infant
M4573B	Soft Disposable, pediatric
M4574B	Soft Disposable, sm adult
M4575B	Soft Disposable, adult
M4576B	Soft Disposable, adult x-long
M4577B	Soft Disposable, lg adult
M4578B	Soft Disposable, lg adult x-long
M4579B	Soft Disposable, thigh

Pressure Cuff Interconnect Tubing

M1598B	Interconnect tubing for all adult & pediatric cuffs, 4.92' (1.5m) length
M1599B	Interconnect tubing for all adult & pediatric cuffs, 9.84' (3.0m) length

Neonatal Pressure Cuffs (non-sterile)

M1866A	Disposable cuff, sz 1 neonatal
M1868A	Disposable cuff, sz 2 neonatal
M1870A	Disposable cuff, sz 3 neonatal
M1872A	Disposable cuff, sz 4 neonatal

Pressure Cuff Interconnect Tubing (Neonatal)

M1596B	Interconnect tubing for neonatal cuffs, 4.92' (1.5m) length
M1597B	Interconnect tubing for neonatal cuffs, 9.84' (3.0m) length

M1008B (active)

Universal NIBP Module

Reusable Pressure Cuffs

M1571A	Reusable pressure cuff, infant
M1572A	Reusable pressure cuff, pediatric
M1573A	Reusable pressure cuff, small adult
M1574A	Reusable pressure cuff, adult
M1575A	Reusable pressure cuff, large adult
M1576A	Reusable pressure cuff, thigh
M1577A	Reusable pressure cuff kit, 4 smaller cuffs (M1571A,72A,73A, 74A)
M1578A	Reusable pressure cuff kit, 4 larger cuffs (M1573A, 74A, 75A, 76A)
M1579A	Reusable pressure cuff kit, (M1571A, 72A, 73A, 74A, 75A, 76A)
M4552B	Antimicrobial reusable cuff, infant
M4553B	Antimicrobial reusable, pediatric
M4554B	Antimicrobial reusable, sm adult

M4555B	Antimicrobial reusable, adult
M4556B	Antimicrobial reusable, adult x-long
M4557B	Antimicrobial reusable, lg adult
M4558B	Antimicrobial lg adult, x-long
M4559B	Antimicrobial reusable, thigh

Disposable Pressure Cuffs (non-sterile)

M1874A	Disposable cuff, infant size
M1875A	Disposable cuff, pediatric size
M1876A	Disposable cuff, small adult size
M1877A	Disposable cuff, adult size, non-sterile
M1878A	Disposable cuff, large adult size
M1879A	Disposable cuff, thigh size

M4572B	Soft Disposable, infant
M4573B	Soft Disposable, pediatric
M4574B	Soft Disposable, sm adult
M4575B	Soft Disposable, adult
M4576B	Soft Disposable, adult x-long
M4577B	Soft Disposable, lg adult
M4578B	Soft Disposable, lg adult x-long
M4579B	Soft Disposable, thigh

Pressure Cuff Interconnect Tubing

M1598B	Interconnect tubing for all adult & pediatric cuffs, 4.92' (1.5m) length
M1599B	Interconnect tubing for all adult & pediatric cuffs, 9.84' (3.0m) length

Neonatal Pressure Cuffs (non-sterile)

M1866A	Disposable cuff, sz 1 neonatal
M1868A	Disposable cuff, sz 2 neonatal
M1870A	Disposable cuff, sz 3 neonatal
M1872A	Disposable cuff, sz 4 neonatal

Pressure Cuff Interconnect Tubing (Neonatal)

M1596B	Interconnect tubing for neonatal cuffs, 4.92' (1.5m) length
M1597B	Interconnect tubing for neonatal cuffs, 9.84' (3.0m) length

**M1012A (active)
Cardiac Output Module****Cardiac Output Supplies**

14455A	Ice bucket for cardiac output, styrofoam
15244A	Remote start handswitch cable for cardiac output
M1642A	Cardiac output cable, 2.7m

Reusable Temperature Probes

23001A/B	CO-Set reusable injectate temp probe
23002A	Ice bath reusable static temp probe

**M1012A #C10 (active)
Continuous Cardiac Output Module****Cardiac Output Supplies**

14455A	Ice bucket for cardiac output, styrofoam
15244A	Remote start handswitch cable for cardiac output
M1643A	Cardiac output cable, 4.8m

Reusable Temperature Probes

23001B	CO-Set reusable injectate temp probe
--------	--------------------------------------

M1013A Essential Gas Module (active)

13902A	Disposable elbow airway adapter
M1658A	Gas Sample Tube
M1657A	Watertrap
M1612A	Straight Airway Adapter
M1655A	Gas Exhaust Return Line (Non-U.S.)
M1656A	Gas Exhaust Return Filter (Non-U.S.)
M1662A	Calibration Gas
M1659A	Calibration Bag

**M1015A (active)
CO₂ Sidestream Module****Gas Monitoring Supplies**

13901A	Nafion sample tube
13902A	Disposable elbow airway adapter
13904A	Disposable bacteria filter
13905A	Nafion/polyethylene sample tube,
M1612A	Disposable straight airway adapter

**M1016A (active)
CO₂ Monitoring Module****Gas Monitoring Supplies**

13901A	Nafion sample tube
13902A	Disposable elbow airway adapter
13904A	Disposable bacteria filter
13905A	Nafion/polyethylene sample tube
14363A	Reusable pediatric airway adapter
M1460A	CO ₂ sensor
M1465A	Reusable standard airway adapter
M1612A	Disposable straight airway adapter

**M1018A (active)
TcPO₂/CO₂ Module****Gas Monitoring Supplies**

15209-60010	Accessory kit
15209-60020	Fixation kit
15210-600100	CAL gas cylinder (U.S.)

15210-60020	CAL gas cylinder
15210-64010	CAL gas cylinder (Meets International standards)
M2205A	Replacement tubing

TcPO₂/CO₂ Sensor	
M1918A	TcPO ₂ /CO ₂ sensor

M1020A, (obsolete)
M1020B (active)
Pulse Oximetry/Plethysmography Module (see Chapt. 9 for full sensor listing)

SpO₂ Sensors:
 (See Chapter 9 for instrument compatibility.)

M1025A (obsolete)
Anesthetic Gas Analyzer

Gas Monitoring Supplies

13901A	Sample tube
13902A	Elbow airway adapter
13904A	Bacteria filter
13905A	Hybrid sample tube (Europe only)
13906A	Calibration gas cylinder
13907A	Calibration tube assembly

M1025B (obsolete)
Anesthetic Gas Analyzer

Gas Monitoring Supplies

13901A	Sample tube
13902A	Elbow airway adapter
13904A	Bacteria filter
13905A	Hybrid sample tube (Europe only)
13906A	Calibration gas cylinder
13907A	Calibration tube assembly

M1026A Opt A01 (obsolete)
Anesthetic Gas Module

Gas Monitoring Supplies

13901A	Gas Sample tube
13902A	Elbow airway adapter
13904A	Inlet Bacteria filter
13905A	Hybrid sample tube (Europe only)
M1612A	Straight airway adapter
M1655A	Reusable gas exhaust return line

M1656A	Disposable gas exhaust return filter
M1659A	Calibration bag
M1660A	Calibration gas cylinder

M1026A Opt A02 (obsolete)
M1026A Opt A05
Anesthetic Gas Module

Gas Monitoring Supplies

13902A	Airway Adapter, 15mm (right angle)
M1612A	Airway Adapter (straight)
M1655A	Gas Exhaust Return Line
M1656A	Gas Exhaust Return Filter
M1657B	Water trap
M1658A	Gas sample tubing
M1659A	Calibration bag
M1660A	Calibration gas cylinder

M1026A Anesthetic Gas Module (obsolete)

Gas Monitoring Supplies

13901A	Reusable Nafion sample tube
13902A	Disposable elbow airway adapter
13904A	Disposable bacteria filter
13905A	Disposable Hybrid Nafion/polyethylene sample tube.
13907A	Calibration tube assembly
M1612A	Disposable straight airway adapter
M1658A	Gas sample tube

M1026B Anesthetic Gas Module (active)

Gas Monitoring Supplies

13902A	Disposable elbow airway adapter
M1612A	Disposable straight airway adapter
M1658A	Gas sample tube
M1657A	Watetrap
M1655A	Gas Exhaust Return Line
M1656A	Gas Exhaust Return Filter
M1662A	Calibration Gas
M1659A	Calibration Bag

M1027A (active)
EEG Parameter Module

M2268A	EEG 2.7m Trunk Cable
M1931A	Reusable 10mm silver/silverchloride lead-wire cup electrode (adult)
M1932A	Reusable 6mm silver/silverchloride lead-wire cup electrode (ped/neonatal)
M1934A	Reusable 5-ld cables with miniclip connector
M1935A	Wet gel electrodes

M1029A (active)
Temperature Module

Disposable Temperature Probes

21082A/B	Phone plug ext. cable for disp temp probe
21090A	Disposable general purpose temp probe, 12Fr
21091A	Disposable skin surface temp probe
21093A	Disposable esophageal stethoscope temp probe, 12 Fr
21094A	Disposable esophageal stethoscope temp probe, 18 Fr
21095A	Disposable esophageal stethoscope temp probe, 24 Fr
21096A	Disposable Foley Catheter temp probe, 16 Fr
21097A	Disposable Foley Catheter temp probe, 18 Fr
M1837A	Disposable general purpose temp probe, 9 Fr
M2255A	Disposable Foley Catheter temp probe, 14 Fr

Reusable Temperature Probes

21075A	General purpose temp probe
21076A	Small temp probe, flexible
21078A	Skin surface temp probe, tape-on

M1034A (active)
BIS Module

M1997A	Aspect BIS Sensor Quatro
M1998A	Aspect BIS Sensor Pediatric

M1034AX (active)
BIS AX Module for IntelliVue C.0 or higher

M1997A	Aspect BIS Sensor Quatro
M1998A	Aspect BIS Sensor Pediatric
989803143581	BIS Sensor Pediatric
M4615A	BIS SRS Sensor

M1116A (obsolete)
Thermal Array Recorder Module
M1116B (active)
Thermal Array Recorder Module

Paper	
40477A/B	Unprinted chem/thermal array, rolls

M1117A (active)
Multi-Channel Thermal Array Recorder Module

Paper	
40469A	Multi-channel thermal array Z-fold

M1118A (obsolete)
Multi-Channel Thermal Array Recorder

Paper	
M1884A	Unprinted multi-channel, Z-fold
M1885A	A4, unprinted multi-channel Z-fold

M1122A (obsolete)
Bedside Recorder

Paper	
40477A/B	Unprinted chem/thermal array, rolls

M1165A/M1166A/M1167A/M1175A/M1177A (active)
Viridia Component Monitoring System
ECG & ECG/Respiration Modules M1001A/B and M1002A/B & Opt C01Trunk Cables

Accessories:	
3 Lead Sets	5 Lead Sets
M1501A Combiner Block	M1502A Combiner Block
M1503A Cable Org.	M1504A Cable Org. (Shld & OR)
M1509A	Bed Sheet Clip

EEG Module Accessories:

M2268A	EEG 2.7m Trunk Cable
M1931A	Reusable 10mm silver/silverchloride lead-wire cup electrode (adult)
M1932A	Reusable 6mm silver/silverchloride lead-wire cup electrode (ped/neonatal)
M1934A	Reusable 5-ld cables with miniclip
M1935A	Disposable, gel electrodes
M1937A	EEG conductive adhesive paste

Non-Invasive Pressure Module Accessories:

Pressure Cuffs & Interconnection Cables	
M1571A	Reusable pressure cuff, infant
M1572A	Reusable pressure cuff, pediatric
M1573A	Reusable pressure cuff, sm. adult
M1574A	Reusable pressure cuff, adult
M1575A	Reusable pressure cuff, lg adult
M1576A	Comfort Reusable pressure cuff, thigh
M1577A	Comfort Reusable pressure cuff kit
M1578A	Comfort Reusable pressure cuff kit
M1579A	Comfort Reusable pressure cuff kit

M4552B	Antimicrobial reusable cuff, infant
M4553B	Antimicrobial reusable, pediatric
M4554B	Antimicrobial reusable, sm adult
M4555B	Antimicrobial reusable, adult
M4557B	Antimicrobial reusable, lg adult
M4559B	Antimicrobial reusable, thigh
M1874A	Non-sterile disposable cuff, infant
M1875A	Non-sterile disposable cuff, pediatric
M1876A	Non-sterile disposable cuff, adult
M1879A	Non-sterile disposable cuff, thigh
M4572B	Soft Disposable, infant
M4573B	Soft Disposable, pediatric
M4574B	Soft Disposable, sm adult
M4575B	Soft Disposable, adult
M4576B	Soft Disposable, adult x-long
M4577B	Soft Disposable, lg adult
M4578B	Soft Disposable, lg adult x-long
M4579B	Soft Disposable, thigh

M1866A	Non-sterile Neon. disposable cuff, #1
M1868A	Non-sterile Neon. disposable cuff, #2
M1870A	Non-sterile Neon. disposable cuff, #3
M1872A	Non-sterile Neon. disposable cuff, #4
M1596B	Neonatal Interconnect Cable
M1597B	Neonatal Interconnect Cable
M1598B	Adult Interconnect Cable
M1599B	Adult Interconnect Cable

Cardiac Output Module Accessories:

Temperature Probes & Accessories	
14455A	Ice Bucket for Cardiac Output, styrofoam
15244A	Remote Start Switch
23001A	Reusable Injectate Temp Probe
23001B	Reusable Injectate Temp Probe
23002A	Ice Bath Reusable Static Temp Probe
M1642A	Cardiac Output Cable
M1643A	Enhanced Cardiac Output Interface Cable

CO₂ Module Accessories:

Gas Monitoring Accessories	
M1460A	Airway CO ₂ transducer with calstick
M1465A	Reusable Standard Airway Adapter
14363A	Reusable Pediatric Airway Adapter

Sidestream CO₂ Module Accessories:

Gas Monitoring Accessories	
13901A	Sample Tube, 2.4m Nafion
13902A	Airway Adapter, 15mm (right angle)
13904A	Bacterial Filter
13905A	Hybrid Sample Tube (Europe Only)
M1612A	Airway Adapter (straight)

Temperature Module Accessories:

Temperature Probes - Disposable	
21082A	Ext. cable for dispos. temp probes 3m
21082B	Ext. cable for dispos. temp probes 1.5m
21090A	Disp. gen. purpose temp probe
21091A	Disp. skin surface temp probe
21093A	Disp. esophageal/stethoscope temp pr. 12fr
21094A	Disp. esophageal/stethosc. temp pr. 18fr
21095A	Disp. esophageal/stethosc. temp pr. 24fr
21096A	Disp. Foley Catheter temp probe 16fr
21097A	Disp. Foley Catheter temp probe 18fr

Temperature Probes - Reusable

21075A	Gen. Purpose temp probe
21076A	Small flexible temp probe
21078A	skin surface temp probe, tape-on

tcpO₂/tcpCO₂ Module Accessories:

15209-60010	Accessory kit
15210-60010	CAL 1 gas (USA)
15210-64010	CAL 1 gas (EUR & JAP)
15210-64020	CAL 2 gas (EUR & JAP)
M1918A	tcpO ₂ /CO ₂ transducer
M2205A	Calibration Tubing

Thermal Array Recorder Module Accessories:

40477A	10 Rolls Thermal Recorder Paper
40477B	80 Rolls Thermal Recorder Paper

M1205A (obsolete) HP Viridia 24 & 26 Patient Monitor

(see CMS parameter modules M1001A/B, M1002A/B/C01, M1006A/B/C01, M1008A/B, M1012A, M1015A, M1016A, M1018A, M1020A, M1029A, M1116A/B)

M1275A (obsolete) Transport Monitor

(see CMS parameter modules M1001A - M1117A)

Other Supplies

40488A	Rechargeable sealed 12 volt battery
--------	-------------------------------------

M1280A (obsolete) Transport Monitor

(see CMS parameter modules M1001A - M1117A)

M1310A (active) HP Viridia Series 50T Telemetry System

Ultrasound Monitoring Supplies)

40483A	Aquasonic transmission gel, 12/8oz. bottles
40483B	Aquasonic transmission gel, 5 liter

Fetal Scalp Electrodes

15133E	Disposable fetal scalp electrode, single spiral
15133D	Disposable fetal scalp electrode, double spiral, for Europe only
15240A	Direct ECG cable for fetal scalp electrode
M1347A	DECG adapter
M1349A	Disposable fetal adhesive pad electrode

M1362B DECG legplate adapter cable
SEE COMPONENT SETUP IN CHAPT. 4

Fetal Belts

M1562A Reusable abdominal belt, pre-cut
M1500-0642 Reusable abdominal belt with button holes
M1500-0643A Reusable abdominal belt (bulk roll)
M1562B Grey, water resistant abdominal belt
M4602A Grey, water resistant abdominal belt
M4603A Grey, water resistant abdominal belt (bulk roll)
M1569A Fetal belt buttons
14328A Disposable foam abdominal belt
M2208A Disposable abdominal belt
M4601A Reusable, grey, water resistant leg belt (bulk roll)

Intrauterine Pressure (IUP) Products

M1333A Disposable sensor-tip IUP catheter, internal diaphragm
M1334A Reusable connector cable for M1333A
M1348A Reusable connector cable for M1333A

Transducers

CPJ840J5 Memscap pressure transducer for IUP

Pressure Domes

CPJ84022 Memscap single use sterile domes, pk of 50

Pressure Accessories

CPJ84447 Memscap IV Pole Mount
CPJ84046 Memscap Transducer Holder

M1350A (obsolete) Fetal Monitor

Ultrasound Monitoring Supplies

40483A Aquasonic transmission gel, 12/8oz. bottles
40483B Aquasonic transmission gel, 5 liter

Fetal Scalp Electrodes

SEE COMPONENT SETUP IN CHAPT. 4

Fetal Belts: See Chapter 4

Intrauterine Pressure (IUP) Products

M1333A Disposable sensor-tip IUP catheter, internal diaphragm
M1334A Reusable connector cable for M1333A
M1348A Reusable connector cable for M1333A

Paper

M1910A Fetal monitoring recording paper
M1911A Fetal monitoring recording paper
M1913A Fetal monitoring recording paper
M1913J Fetal monitoring recording paper, Japan only

M1350B (obsolete) HP Viridia Series 50 XM

Ultrasound Monitoring Supplies

40483A Aquasonic transmission gel, 12/8oz. bottles
40483B Aquasonic transmission gel, 5 liter

Fetal Scalp Electrodes

15133E Disposable fetal scalp electrode, single spiral
15133D Disposable fetal scalp electrode, double spiral, for Europe only
15240A Direct ECG cable for fetal scalp electrode
M1347A DECG adapter
M1349A Disposable fetal adhesive pad electrode
M1362B DECG legplate adapter cable
989803137631 Philips Single Spiral fetal spiral electrode
989803137641 Philips Double Spiral electrode
989803139771 Philips attachment electrode
989803137651 Philips DECG legplate adapter cable

Fetal Belts: see chapter 4

Intrauterine Pressure (IUP) Products

M1333A Disposable sensor-tip IUP catheter, internal diaphragm
M1334A Reusable connector cable for M1333A

Pressure Transducers

CPJ840J5 Memscap Pressure Transducer for IUP

Pressure Domes

CPJ84022 Memscap single use sterile dome, pk. 50

Pressure Accessories

CPJ84447 Memscap IV Pole Mount
CPJ84046 Memscap Transducer Holder

Paper

M1910A Fetal monitoring recording paper
M1911A Fetal monitoring recording paper
M1913A Fetal monitoring recording paper
M1913J Fetal monitoring recording paper, Japan only

M1350C (active) Viridia Series 50 XMO Fetal Monitor

Fetal Scalp Electrodes

15133E Disposable fetal scalp electrode, single spiral
15133D Disposable fetal scalp electrode, double spiral, for Europe only
15240A Direct ECG cable for fetal scalp electrode
M1347A DECG adapter
M1349A Disposable fetal adhesive pad electrode

M1362B	DECG legplate adapter cable
989803137631	Philips Single Spiral fetal spiral electrode
989803137641	Philips Double Spiral electrode
989803139771	Philips attachment electrode
989803137651	Philips DECG legplate adapter cable

Fetal Belts: see chapter 4

Intrauterine Pressure (IUP) Products

M1333A	Koala Disposable IUP catheter, internal diaphragm
M1334A	Reusable connector cable for M1333A
CPJ840J5	Memscap Pressure Transducer
CPJ84022	Memscap Single Use Sterile Dome, pk. 50
CPJ84447	Memscap IV Pole Mount
CPJ84046	Memscap Transducer Holder

NIBP Accessories:
(See Chapter 6 for instrument compatibility.)

Maternal SpO₂ Accessories:
(See Chapter 9 for instrument compatibility.)

M1351A (active) HP Viridia Series 50 A Antepartum

Ultrasound Monitoring Supplies

40483A	Aquasonic transmission gel, 12/8oz. bottles
40483B	Aquasonic transmission gel, 5 liter
M1355-60011	Toco transducer for external monitoring of uterine activity.
M1356-60011	Doppler ultrasound FHR transducer
M1356-43203	Fetal monitor transducer knob adapter

Fetal Belts: see chapter 4

Fetal Scalp Electrodes

15133E	Disposable fetal scalp electrode, single spiral
15133D	Disposable fetal scalp electrode, double spiral, for Europe only
15240A	Direct ECG cable for fetal scalp electrode
M1347A	DECG adapter
M1349A	Disposable fetal adhesive pad electrode
M1362B	DECG legplate adapter cable
989803137631	Philips Single Spiral fetal spiral electrode
989803137641	Philips Double Spiral electrode
989803139771	Philips attachment electrode
989803137651	Philips DECG legplate adapter cable

Paper

M1910A	Fetal monitoring recording paper, orange grid
M1911A	Fetal monitoring recording paper, kPa scale, green grid
M1913A	Fetal monitoring recording paper, 1 min

M1913J	highlights, green grid Fetal monitoring recording paper, 1 min highlights, green grid, Japan only
--------	--

M1353A (active) HP Viridia Series 50 IP Intrapartum

Ultrasound Monitoring Supplies

40483A	Aquasonic transmission gel, 12/8oz. bottles
40483B	Aquasonic transmission gel, 5 liter
M1355-60011	Toco transducer for external monitoring of uterine activity.
M1356-60011	Doppler ultrasound FHR transducer
M1356-43203	Fetal monitor transducer knob adapter

Fetal Scalp Electrodes

15133E	Disposable fetal scalp electrode, single spiral
15133D	Disposable fetal scalp electrode, double spiral, for Europe only
15240A	Direct ECG cable for fetal scalp electrode
M1347A	DECG adapter
M1349A	Disposable fetal adhesive pad electrode
M1362B	DECG legplate adapter cable

989803137631	Philips Single Spiral fetal spiral electrode
989803137641	Philips Double Spiral electrode
989803139771	Philips attachment electrode
989803137651	Philips DECG legplate adapter cable

Fetal Belts: see Chapter 4

Intrauterine Pressure (IUP) Products

M1333A	Disposable sensor-tip IUP catheter, internal diaphragm
M1334A	Reusable connector cable for M1333A
CPJ840J5	Memscap Pressure Transducer
CPJ84022	Memscap Single Use Sterile Dome, pk. 50
CPJ84447	Memscap IV Pole Mount
CPJ84046	Memscap Transducer Holder

SpO₂ Sensor Supplies:
(See Chapter 9 for instrument compatibility.)

NIPB Supplies:
(See Chapter 6 for instrument compatibility.)

Electrodes:

40493E	Pre-gelled (wet) Adult ECG foam electrodes
40489E	Pre-gelled (wet) adult ECG tape electrodes

Paper

M1910A	Fetal monitoring recording paper, orange grid
M1911A	Fetal monitoring recording paper, kPa scale, green grid
M1913A	Fetal monitoring recording paper, 1 min highlights, green grid
M1913J	Fetal monitoring recording paper, 1 min

highlights, green grid, Japan only

M1400A (obsolete) **Telemetry Transmitter**

Telemetry Supplies

40455A	Zinc-air battery
9300-0768-050	Disposable telemetry pouches
9300-0768-200	Disposable telemetry pouches

M1403A (obsolete) **Digital UHF Telemetry** **Monitoring System**

Monitoring/Ultrasound Imaging Lead Sets

M1420A	3-lead set, snap for M1403A, AAMI
M1421A	3-lead set, grabber for M1403A, AAMI
M1422A	4-lead set, snap for M1403A, AAMI
M1423A	4-lead set, grabber for M1403A, AAMI
M1424A	5-lead set, snap for M1403A, AAMI
M1425A	5-lead set, grabber for M1403A, AAMI
M1430A	3-lead set, snap for M1403A, IEC
M1431A	3-lead set, grabber for M1403A, IEC
M1432A	4-lead set, snap for M1403A, IEC
M1433A	4-lead set, grabber for M1403A, IEC
M1434A	5-lead set, snap for M1403A, IEC
M1435A	5-lead set, grabber for M1403A, IEC

Electrodes

(See Electrode section of the Medical Supplies Reference Guide for detailed listing.)

M1700A (obsolete) **PageWriter XLi Cardiograph**

M1701A (obsolete) **PageWriter XLs Cardiograph**

M1702A (obsolete) **PageWriter XLe Cardiograph**

Cardiography Trunk Cables

M1719A	Patient data cable, 8' (2.5m)
M1720A	Patient data cable, 30' (9m)

Cardiography Lead Sets

M1713B	Complete lead set, AAMI
M1716B	Complete lead set, IEC

Cardiography Replacement Leads and Accessories

40431B	Alligator clip lead adapter, AAMI
40432B	Alligator clip lead adapter, IEC
40475A	Lead adapter - post to snap
40498E	Lead adapter - post to grabber, IEC
M1711A	Limb leads, AAMI
M1712B	Chest leads, AAMI
M1714A	Limb leads, IEC
M1715B	Chest leads, IEC

M1717B	Pediatric and Frank leads, AAMI & IEC
M1718A	Shorting plug set
M2254A	Electrode adapter, tab to cardiograph lead wire, 1/8" and 4mm banana plug leads

Other Supplies

M1721A	Battery assembly
--------	------------------

Paper

M1707A	PageWriter paper with header, 8-1/2" x 11" red grid
M1708A	PageWriter paper without header, 8-1/2" x 11" warm red grid
M1709A	PageWriter paper with header, A4 red grid
M1710A	PageWriter paper without header, A4 red grid
M2206A	Anti-fade PageWriter paper, 8-1/2" x 11", red grid
M2207A	Anti-fade PageWriter paper, A4 red grid
M2242B	PageWriter, A4, light red grid (Asia-Pacific only)
M2481A	PageWriter thermal paper z-fold, w/header 8-1/2" x 11" light red grid
M2483A	PageWriter paper with header, A4, light red grid
M2485A	Anti-fade PageWriter paper, 8-1/2" x 11", light red grid
M2486A	Anti-fade PageWriter paper, A4 light red grid

Electrodes

(See Electrode section of the Medical Supplies Reference Guide for detailed listing.)

M1722A (obsolete) **CodeMaster XL+ Defibrillator**

M1722B (obsolete) **CodeMaster XL+ Defibrillator (yellow)**

M1723A (obsolete) **CodeMaster XL Defibrillator**

M1723B (obsolete) **CodeMaster XL Defibrillator (yellow)**

ECG Safety Trunk Cables

M1500A	3-lead safety trunk cable, AAMI, 12-pin connector
M1510A	3-lead safety trunk cable, IEC 12-pin connector
M1520A	5-lead safety trunk cable, AAMI 12-pin connector (M1722A/B only)
M1530A	5-lead safety trunk cable, IEC 12-pin connector (M1722A/B only)
M1580A	3-lead safety trunk cable, AAMI 8-pin connector
M1590A	3-lead safety trunk cable, IEC 8-pin connector

M1600A	5-lead safety trunk cable, AAMI 8-pin connector (M1722A/B only)
M1610A	5-lead safety trunk cable, IEC 8-pin connector (M1722A/B only)

ECG Safety Cable Lead Sets

M1605A	3-lead safety lead set, snap, AAMI
M1615A	3-lead safety lead set, snap, IEC
M1625A	5-lead safety lead set, snap, AAMI
M1635A	5-lead safety lead set, snap, IEC

ECG Safety Cable Accessories

M1501A	Combiner for 3-lead sets, 3/pack
M1502A	Combiner for 5-lead sets, 3/pack
M1503A	Organizer for shielded 3-lead sets,
M1504A	Organizer for shielded 5-lead sets
M1509A	Bedsheet clip, repositionable, 3/pack
M2281A	Patient cable organizer, 8/pack

Cardiology Cable Accessories

M1783A	Sync interface cable (12 pin), 8' (2.5m)
--------	--

Defibrillator Supplies

(See Defibrillator section of the Medical Supplies Reference Guide for detailed listing.)

Paper

40457C	1-ch chem/therm paper, 10 rolls/case
40457D	1-ch chem/therm paper, 80 rolls/case

SpO₂ Sensors:

(See Chapter 9 for instrument compatibility.)

M1724A (obsolete) CodeMaster XE Defibrillator

Defibrillator Supplies

(See Defibrillator section of the Medical Supplies Reference Guide for detailed listing.)

M1730A (obsolete) ECG Management System

Paper

M1737A	Red grid LaserJet paper, 8-1/2" x 11"
M1738A	Red grid LaserJet paper, A4

M1770A (obsolete) PageWriter 300pi Cardiograph

M1771A (obsolete) PageWriter 200 Cardiograph

M1772A (obsolete)

PageWriter 100 Cardiograph

Cardiology Trunk Cables

M3702C	ECG patient cable, 10 leads, AHA
M3703C	ECG patient cable, 10 leads, IEC (Europe)

Cardiology Replacement Leads and Accessories

40431B	Alligator clip lead adapter
40432B	Alligator clip lead adapter
40475A	Lead adapter - post to snap
40498E	Lead adapter - post to grabber, IEC
M2254A	Electrode adapter, tab to cardiograph leadwire, 1/8" post and 4mm banana plug

Other Supplies

M2460A	Battery assembly
M2463A	Carrying case

Paper

M2481A	PageWriter thermal paper, Z-fold w/header 8-1/2" x 11"
M2483A	PageWriter paper with header, A4, light red grid
M2485A	Anti-fade PageWriter paper, 8-1/2" x 11", light red grid
M2486A	Anti-fade PageWriter paper, A4 light red grid

Electrodes:

40494E	Limb clamp electrode
M2253A	Disposable Tab style solid gel electrode
13943B	High performance tab style solid gel electr.

M1918A (active) Transcutaneous Transducer

Gas Monitoring Supplies

15209-60010	Accessory kit for M1918A transducer
15209-60020	Fixation kit for M1918A transducers
15210-60010	CAL 1 gas cylinder for TcPO ₂
15210-64010	CAL 1 gas cylinder
M2205A	Cal tubes

M2040A/M2045A (obsolete) with Opt. K01 or K02 MIDA System

MIDA Cables and Leads

M1950A	10-lead patient trunk cable, IEC
M1951A	8-lead patient trunk cable, IEC
M1952A	5-lead safety lead set, grabber, IEC
M1953A	3/5-lead safety lead set, grabber, IEC
M1954A	0.5m adapter cable, IEC
M1955A	2.0m adapter cable, IEC
M1530A	5-lead ECG Trunk Cable, IEC
M1633A	ECG 5-lead - Grabbers, IEC
40489E	Adult ECG Electrodes - Paper Tape
40493E	Adult ECG Electrodes - Foam Pad

M2340A (obsolete)
Central Station
Monitoring System

M2350A (obsolete)
Central Station
Monitoring System

M2360A (obsolete)
Central Station
Monitoring System

Paper for use with M1116A/B recorders
 40477A/B Unprinted chem/thermal array, rolls

Paper for use with M1117A recorder
 40469A Multi-channel thermal array Z-fold

M2400A (obsolete)
Sonos Intravascular Imaging
System

Ultrasound Monitoring Supplies

40483A Aquasonic transmission gel, 12/8oz. bottles
 40483B Aquasonic transmission gel, 5 liter

ECG Safety Trunk Cables

M1580A ECG 3-ld safety connector trunk cable, AAMI
 M1590A ECG 3-ld safety connector trunk cable, IEC

ECG Safety Cable Lead Sets

M1603A Shielded 3-lead set, grabber, safety, AAMI
 M1609A Pediatric, non-shielded 3-lead set, AAMI
 M1613A Shielded 3-lead set, grabber, safety, IEC
 M1619A Pediatric, non-shielded 3-lead set, IEC

ECG Safety Replacement Leads

(See Cable section of the Medical Supplies Reference Guide for detailed listing.)

ECG Safety Cable Accessories

M1501A Combiner for 3-lead sets, 3/pack
 M1503A Organizer for shielded 3-lead sets,
 M1509A Bedsheet clip, repositionable, 3/pack
 M2281A Patient cable organizer, 8/pack

M2406A (obsolete)
Sonos 2000 and 2500 Imaging Systems

Ultrasound Monitoring Supplies

13920B 1/2" VHS cassette tape
 13921B 1/2" Super VHS cassette tape

40483A Aquasonic transmission gel, 12/8oz. bottles
 40483B Aquasonic transmission gel, 5 liter
 40487A Transesophageal transducer sheath kit
 M1828A Disposable TEE bite guard, adult
 M2203A MiniTEE bite guard

ECG Safety Trunk Cables

M1580A ECG 3-ld safety connector trunk cable, AAMI
 M1590A ECG 3-ld safety connector trunk cable, IEC

ECG Safety Cable Lead Sets

M1603A Shielded 3-lead set, grabber, safety, AAMI
 M1609A Pediatric, non-shielded 3-lead set, AAMI
 M1613A Shielded 3-lead set, grabber, safety, IEC
 M1619A Pediatric, non-shielded 3-lead set, IEC

ECG Safety Replacement Leads

(See Cable section of the Medical Supplies Reference Guide for detailed listing.)

ECG Safety Cable Accessories

M1501A Combiner for 3-lead sets, 3/pack
 M1503A Organizer for shielded 3-lead sets
 M1509A Bedsheet clip, repositionable, 3/pack
 M2281A Patient cable organizer, 8/pack

Paper

40479A Ultrasound strip chart recorder paper

Electrodes

(See Electrode section of the Medical Supplies Reference Guide for detailed listing.)

M2424A Opt A06/M2425A
Sonos 4500 Fusion Imaging System (active)
M2424A-A05/M2425A-K25
Sonos 5500 Fusion Imaging System (active)

Paper

40479A Kowa Thermal Paper

Ultrasound Monitoring Supplies

40483A/B Aquasonic Gel
 M1828A Bite Guard (adult)
 13921B VHS tape, 1/2" super VHS
 40487A/E TEE Sheath Kits
 M2243A Omni II Tip Protectors

ECG Safety Trunk Cables

M1580A ECG 3-ld safety connector trunk cable, AAMI
 M1590A ECG 3-ld safety connector trunk cable, IEC

ECG Safety Cable Lead Sets

M1603A Shielded 3-lead set, grabber, safety, AAMI

M1605A	Shielded 3-lead set, Snap, safety, AAMI
M1609A	Pediatric, non-shielded 3-lead set, AAMI
M1613A	Shielded 3-lead set, grabber, safety, IEC
M1615A	Shielded 3-lead set, snap, safety, IEC
M1619A	Pediatric, non-shielded 3-lead set, IEC

M2430A (active) OptiGo Point of Care Ultrasound

Ultrasound Imaging Supplies

40483A	Water soluble transmission gel
40483B	Water soluble transmission gel refill

M2475B (obsolete) CodeMaster 100 Portable Defibrillator

Cardiography Cable Accessories

M1783A	Sync interface cable (12 pin), 8' (2.5m)
--------	--

ECG Safety Cable Accessories

M1501A	Combiner for 3-lead sets, 3/pack
M1502A	Combiner for 5-lead sets, 3/pack
M1503A	Organizer for shielded 3-lead sets
M1504A	Organizer for shielded 5-lead sets
M1509A	Bedsheet clip, repositionable, 3/pack
M2281A	Patient cable organizer, 8/pack

Defibrillator Supplies

(See Defibrillator section of the Medical Supplies Reference Guide for detailed listing.)

Paper

40457C	1-ch chem/therm paper, 10 rolls/case
40457D	1-ch chem/therm paper, 80 rolls/case

SpO₂ Sensors and Accessories

SEE CHAPTER 9 FOR INSTRUMENT COMPATIBILITY.

Other Supplies

M2473A	Accessory pouch
M2474A	Carrying case and accessory pouch
M2476B	2.5 amp-hr Nicad battery
M2477B	4.0 amp-hr Nicad battery
M3711A	Carrying case/accessory pouch
M3712A	Accessory pouch

M2600A (obsolete) HP Viridia Telemetry System

Telemetry Lead Sets

M2590A	3-lead telemetry set, snap, AAMI
M2591A	3-lead telemetry set, grabber, AAMI

M2592A	5-lead telemetry set, snap, AAMI
M2593A	5-lead telemetry set, grabber, AAMI
M2594A	3-lead telemetry set, snap, IEC
M2595A	3-lead telemetry set, grabber, IEC
M2596A	5-lead telemetry set, snap, IEC
M2597A	5-lead telemetry set, grabber, IEC

Telemetry Supplies

M2598A	3-lead combiner shield (US only)
M2599A	5-lead combiner shield (US only)
ULBU9VLJ	Lithium 9-volt battery

M2601A (obsolete) TeleMon Monitor

Telemetry Lead Sets

M2590A	3-lead telemetry set, snap, AAMI
M2591A	3-lead telemetry set, grabber, AAMI
M2592A	5-lead telemetry set, snap, AAMI
M2593A	5-lead telemetry set, grabber, AAMI
M2594A	3-lead telemetry set, snap, IEC
M2595A	3-lead telemetry set, grabber, IEC
M2596A	5-lead telemetry set, snap, IEC
M2597A	5-lead telemetry set, grabber, IEC
M1509A	Bedsheet Clip

Telemetry Supplies

M2598A	3-lead combiner shield
M2599A	5-lead combiner shield

Electrodes

M2202A	Disposable Radiolucent foam electrode
40489E	Disposable pre-gelled electrode
40493D/E	Disposable adult ECG foam electrode

SpO₂ Sensors and Accessories

(See Chapter 9 for instrument compatibility.)

Non-Invasive Blood Pressure Cuffs & Accessories

(See Chapter 9 for instrument compatibility.)

Miscellaneous

M4790A	Spare battery pack
--------	--------------------

M2636A (obsolete) Telemon B

ECG Transmitter Trunk Cable

M4793A	5-lead AAMI
M4794A	5-lead IEC
M4795A	3-lead AAMI
M4796A	3-lead IEC

Miscellaneous

M4790A	Rechargeable battery
--------	----------------------

Lead Sets, NIBP, SpO₂ & Electrodes:

See supplies for M2601A

(See Chapter 6 for instrument compatibility.)

M2636C (active)**Philips TeleMon Monitor**

M1598B	NIBP tube
M1599B	NIBP tube
M1572A	Pediatric NIBP cuff
M1573A	Small adult NIBP cuff
M1574A	Adult NIBP cuff
989803143491	TeleMon tether cable

M2662A (active)**PageWriter 10/10
Electrocardiograph****Cardiograph Trunk Cables**

M3703A	Color coded shielded trunk cable (IEC)
M3702A	Color coded shielded trunk cable (AHA)

Cardiography Replacement Leads and Accessories

40431B	Alligator clip lead adapter
40432B	Alligator clip lead adapter
40475A	Lead adapter - post to snap
40498E	Lead adapter - post to grabber, IEC
M2254A	Electrode adapter, tab to cardiograph lead wire, 1/8" post and 4mm banana plug

Electrode

40494E	Limb plate electrode
--------	----------------------

Battery

M3941A	Ni-MH Battery Pack
--------	--------------------

M2702A/ M2703A (active)**Avalon FM20/FM30 Fetal Monitor**

M2738A	Fetal/Maternal ECG patient module
989803137631	Single Fetal Spiral Electrode
989803137641	Double Fetal Spiral Electrode
989803137651	Legplate adapter cable
989803139771	Attachment electrode
M2208A	Disposable belt
M4602A	Reusable belt
M4603A	Reusable belt
989803143401	Belt clip
M1333A	Koala IUP catheter
989803143941	Koala adapter cable
M1910A	paper
M1911A	paper
M1913A	paper
M1913J	paper
989803143471	Event marker
40483A	Aquasonic transmission gel, 12/8oz. bottles

SpO₂ Sensor Supplies

(See Chapter 9 for instrument compatibility.)

NIBP Supplies**M3000A (active)****Multi-Measurement
Server (with Opt's. ECG, NIBP, SpO₂)****ECG Safety Trunk Cables**

M1669A	ECG 3-ld safety connector trunk cable, AAMI/IEC
M1668A	ECG 5-ld safety connector trunk cable, AAMI/IEC

ECG Safety Cable Lead Sets

M1675A	OR 3-lead set, grabber, AAMI
M1671A	Shielded 3-lead set, grabber, safety, AAMI
M1673A	Shielded 3-lead set, snap, safety, AAMI
M1622A	Unshielded 3-lead set, safety, AAMI
M1624A	Unshielded 3-lead set, safety, AAMI
M1678A	OR 3-lead set, grabber, safety, IEC
M1672A	Shielded 3-lead set, grabber, safety, IEC
M1674A	Shielded 3-lead set, snap, safety, IEC
M1626A	Unshielded 3-lead set, safety, IEC
M1621A	Shielded OR 5-lead grabber, safety, AAMI
M1968A	Shielded 5-lead set, grabber, safety, AAMI
M1644A	Shielded 5-lead set snap, safety, AAMI
M1647A	Unshielded 5-lead set, safety, AAMI
M1974A	Shielded OR 5-lead set, grabber, safety, IEC
M1971A	Shielded 5-lead set, grabber, safety, IEC
M1645A	Shielded 5-lead set snap, safety, IEC
M1648A	Unshielded 5-lead set, safety, IEC

ECG Safety Cable Accessories

M1503A	Organizer for shielded 3-lead sets
M1504A	Organizer for shielded 5-lead sets
M1509A	Bedsheet clip, repositionable, 3/pack
M2281A	Patient cable organizer, 8/pack

Reusable Pressure Cuffs

M1571A	Reusable pressure cuff, infant
M1572A	Reusable pressure cuff, pediatric
M1573A	Reusable pressure cuff, small adult
M1574A	Reusable pressure cuff, adult
M1575A	Reusable pressure cuff, large adult
M1576A	Reusable pressure cuff, thigh
M4552B	Antimicrobial reusable cuff, infant
M4553B	Antimicrobial reusable, pediatric
M4554B	Antimicrobial reusable, sm adult
M4555B	Antimicrobial reusable, adult
M4556B	Antimicrobial reusable, adult x-long
M4557B	Antimicrobial reusable, lg adult
M4558B	Antimicrobial reusable, lg adult, x-long
M4559B	Antimicrobial reusable, thigh

Disposable Pressure Cuffs (non-sterile)

M1874A	Disposable cuff, infant size
M1875A	Disposable cuff, pediatric size
M1876A	Disposable cuff, small adult size
M1877A	Disposable cuff, adult size, non-sterile
M1878A	Disposable cuff, large adult size
M1879A	Disposable cuff, thigh size
M4572B	Soft Disposable, infant
M4573B	Soft Disposable, pediatric
M4574B	Soft Disposable, sm adult
M4575B	Soft Disposable, adult

M4576B	Soft Disposable, adult x-long
M4577B	Soft Disposable, lg adult
M4578B	Soft Disposable, lg adult x-long
M4579B	Soft Disposable, thigh

Neonatal Pressure Cuffs

M1866A	Disposable neonatal cuff, sz 1
M1868A	Disposable neonatal cuff, sz 2
M1870A	Disposable neonatal cuff, sz 3
M1872A	Disposable neonatal cuff, sz 4

Pressure Cuff Interconnect Tubing

M1596B	Interconnect tubing for neonatal cuffs, 4.92' (1.5m) length
M1597B	Interconnect tubing for neonatal cuffs,
M1598B	Interconnect tubing for all adult & pediatric cuffs, 4.92' (1.5m) length
M1599B	Interconnect tubing for all adult & pediatric cuffs, 9.84' (3.0m) length

SpO₂ Sensors and Accessories

(See Chapter 9 for instrument compatibility.)

M3001A (active) **IntelliView Multi-Measurement Server (with Opt's. ECG, NIBP, SpO₂)**

ECG Safety Trunk Cables (12 pin input connector)

M1669A	ECG 3-ld safety connector trunk cable, AAMI/IEC
M1668A	ECG 5-ld safety connector trunk cable, AAMI/IEC
M1667A	ECG 6-ld safety connector trunk cable, AAMI/IEC
M1663A	ECG 10-ld (5+5) safety connector trunk cable, AAMI/IEC
M1665A	ECG 10-ld (6+4) safety connector trunk cable.

ECG Safety Cable Lead Sets

M1675A	OR 3-lead set, grabber, AAMI
M1671A	Shielded 3-lead set, grabber, safety, AAMI
M1673A	Shielded 3-lead set, snap, safety, AAMI
M1622A	Unshielded 3-lead set, safety, AAMI
M1624A	Unshielded 3-lead set, safety, AAMI
M1678A	OR 3-lead set, grabber, safety, IEC
M1672A	Shielded 3-lead set, grabber, safety, IEC
M1674A	Shielded 3-lead set, snap, safety, IEC
M1626A	Unshielded 3-lead set, safety, IEC
M1621A	Shielded OR 5-lead grabber, safety, AAMI
M1968A	Shielded 5-lead set, grabber, safety, AAMI
M1644A	Shielded 5-lead set snap, safety, AAMI
M1647A	Unshielded 5-lead set, safety, AAMI
M1974A	Shielded OR 5-lead set, grabber, safety, IEC
M1971A	Shielded 5-lead set, grabber, safety, IEC
M1645A	Shielded 5-lead set snap, safety, IEC
M1648A	Unshielded 5-lead set, safety, IEC
M1680A	Shielded 6-lead grabber, safety, AAMI
M1682A	Shielded 6-lead snap, safety, AAMI
M1684A	Shielded OR 6-lead grabber, safety, AAMI
M1532A	Shielded 4-lead, snap, AAMI
M1537A	Shielded 4-lead, grabber, AAMI
M1557A	Shielded OR 4-lead, grabber, AAMI
M1681A	Shielded 6-lead grabber, IEC

M1683A	Shielded 6-lead snap, IEC
M1685A	Shielded OR 6-lead grabber, IEC
M1533A	Shielded 4-lead grabber, IEC
M1538A	Shielded 4-lead snap, IEC
M1558A	Shielded OR 4-lead grabber, IEC

ECG Safety Cable Accessories

M1503A	Organizer for shielded 3-lead sets
M1504A	Organizer for shielded 5-lead sets
M1664A	Organizer for shielded 4-lead sets
M1679A	Organizer for shielded 6-lead sets
M1636A	Organizer for unshielded 3-lead sets
M1638A	Organizer for unshielded 5-lead sets
M1509A	Bedsheet clip, repositionable, 3/pack
M2598A	3-lead combiner shield
M2599A	5-lead combiner shield
M2281A	Patient cable organizer, 8/pack

Reusable Pressure Cuffs

M1571A	Reusable pressure cuff, infant
M1572A	Reusable pressure cuff, pediatric
M1573A	Reusable pressure cuff, small adult
M1574A	Reusable pressure cuff, adult
M1575A	Reusable pressure cuff, large adult
M1576A	Reusable (long life) pressure cuff, thigh
M1577A	Reusable pressure cuff kit, 4 smaller cuffs (M1571A, 72A, 73A, 74A)
M1578A	Reusable pressure cuff kit, 4 larger cuffs
M1579A	Reusable pressure cuff kit, (M1571A, 72A, 73A, 74A, 75A, 76A)
M4552B	Antimicrobial reusable cuff, infant
M4553B	Antimicrobial reusable, pediatric
M4554B	Antimicrobial reusable, sm adult
M4555B	Antimicrobial reusable, adult
M4556B	Antimicrobial reusable, adult x-long
M4557B	Antimicrobial reusable, lg adult
M4558B	Antimicrobial reusable, lg adult, x-long
M4559B	Antimicrobial reusable, thigh

Disposable Pressure Cuffs (non-sterile)

M1874A	Disposable cuff, infant size
M1875A	Disposable cuff, pediatric size
M1876A	Disposable cuff, small adult size
M1877A	Disposable cuff, adult size, non-sterile
M1878A	Disposable cuff, large adult size
M1879A	Disposable cuff, thigh size
M4572B	Soft Disposable, infant
M4573B	Soft Disposable, pediatric
M4574B	Soft Disposable, sm adult
M4575B	Soft Disposable, adult
M4576B	Soft Disposable, adult x-long
M4577B	Soft Disposable, lg adult
M4578B	Soft Disposable, lg adult x-long
M4579B	Soft Disposable, thigh

Neonatal Pressure Cuffs

M1866A	Disposable neonatal cuff, sz 1
M1868A	Disposable neonatal cuff, sz 2
M1870A	Disposable neonatal cuff, sz 3
M1872A	Disposable neonatal cuff, sz 4

Pressure Cuff Interconnect Tubing

M1596B	Interconnect tubing for neonatal cuffs, 4.92' (1.5m) length
M1597B	Interconnect tubing for neonatal cuffs, 9.84' (3.0m) length

M1598B	Interconnect tubing for all adult, infant, pediatric cuffs, 4.92' (1.5m) length
M1599B	Interconnect tubing for all adult/infant, pediatric cuffs, 9.84' (3.0m) length

M2533A	Disposable airway adapter, adult
M2536A	Disposable airway adapter, infant
M2505A	Gas regulator
M2506A	Verification

SpO₂ Sensors and Accessories

(See Chapter 9 for instrument compatibility with SpO₂ sensors.)

M3012A (active) Hemodynamic Extension Server

Temperature Accessories

Reusable Temperature Probes

21075A	General purpose probe
21076A	Small flexible vinyl probe (infant/pedi)
21078A	Tape-on surface temp probe

Disposable Temperature Probes

M1837A	Esophageal/rectal temp probes
21091A	Skin surface temp probe
21093A	Esophageal/stethoscope probe
21094A	Esophageal/stethoscope probe
21095A	Esophageal/stethoscope probe
M2255A	Foley catheter probe
21096A	Foley catheter probe
21097A	Foley catheter probe
21082A	Temp probe adapter cable
21082A	Temp probe adapter cable

Pressure Accessories

Pressure Transducers, Reusable

CPJ840J6	Reusable pressure transducer
CPJ84022	Sterile disposable domes for transducer
CPJ84046	Transducer holder
CPJ84447	IV pole mount

Disposable:

M1567A	Single channel sensor kit
M1568A	Dual channel sensor kit
M2271A	Transducer holder
M2272C	IV pole mount
M1634A	adapter cable for disposable kit

Cardiac Output Accessories

M1642A	CO interface cable
M1643A	CO interface cable
M1646A	PiCCO temp probe
23001A	Reusable injectate temp probe
23001B	Reusable injectate temp probe
23002A	Ice bath temp probe
14455A	set of ice buckets
15244A	Remote start handswitch & cable

PiCCO Pressure Transducer Kits not available through Philips.

M3014A IntelliVue Mainstream CO₂ Extension (active)

Supplies and Accessories:

M2501A	Mainstream CO ₂ Sensor
M2513A	Reusable airway adapter, adult/pediatric
M2516A	Reusable airway adapter, infant

M3015A (active) Microstream CO₂ Measurement Extension Server

Microstream CO₂ Monitoring Supplies

M1920A	Adult/pediatric FilterLine set
M1921A	Adult/pediatric FilterLine H set
M1923A	Infant/Neonatal Filterline H set
M2520A	Pediatric Smart CapnoLine O ₂
M2522A	Adult Smart CapnoLine Plus O ₂
M2524A	Pediatric Smart CapnoLine
M2526A	Adult Smart CapnoLine Plus
M4680A	Adult CapnoLine H O ₂
M4681A	Pediatric CapnoLine H O ₂
M4686A	Adult NIV Line
M4687A	Pediatric NIV Line
M4689A	Adult CapnoLine H
M4690A	Pediatric CapnoLine H
M4691A	Infant/neonatal CapnoLine H

M3016A Mainstream CO₂ Measurement Server Extension (active)

Mainstream CO₂ Accessories

M1460A	CO ₂ Transducer including Calstick
M1465A	Reusable Adult Airway Adapter
14363A	Reusable Neonatal Airway Adapter

Pressure Accessories

1295CK-020	Disposable domes (20 pack)
1295CK	Disposable domes (60 pack)
M1551B	Disposable dome kit
1292C	Holder for 2 transducers

Disposable Pressure Transducers (Not avail. in U.S.)

M1567A	Single Channel Kit
M1568A	Dual Channel Kit
M2271A	Transducer Holder
M2272C	IV Pole Mount
M1634A	Adapter Cable (3.0m)

Reusable Temperature Accessories

21075A	General Purpose Probe
21076A	Small Flexible Vinyl Probe (Infant/Ped)
21078A	Attachable Surface Probe

Disposable Temperature Accessories

21090A	General Purpose Probe, 12 FR
M1837A	General Purpose Probe, 9 FR
21091A	Skin Probe
21093A	Esophageal/Stethoscope Probe, 12 FR
21094A	Esophageal/Stethoscope Probe, 18 FR
21095A	Esophageal/Stethoscope Probe, 24 FR
21082A	2-pin plug extension cable
21082B	2-pin plug extension cable

M2741A IntelliVue Sidestream CO₂ Sensor

Supplies and Accessories:

M2744A	CO ₂ Nasal Cannula, adult
M2745A	CO ₂ Nasal Cannula, pediatric
M2746A	CO ₂ Nasal Cannula, infant
M2750A	CO ₂ /O ₂ Nasal Cannula, adult
M2751A	CO ₂ /O ₂ Nasal Cannula, pediatric
M2756A	CO ₂ Oral-Nasal Cannula, adult
M2757A	CO ₂ Oral-Nasal Cannula, pediatric
M2760A	CO ₂ /O ₂ Oral-Nasal Cannula, adult
M2761A	CO ₂ /O ₂ Oral-Nasal Cannula, pediatric
M2768A	Airway Adapter Set
M2772A	Airway Adapter Set H
M2773A	Airway Adapter Set H
M2776A	Straight Sample Line
M2777A	Straight Sample Line H

M3160A (active) 4-channel recorder

PSE11268	Thermal paper
----------	---------------

M3500B (active) Heartstream/HeartStart XLT Defibrillator/Monitor

Defibrillator Supplies

(See Defibrillator section of the Medical Supplies Reference Guide for detailed listing.)

ECG Monitoring Electrodes

M2202A	Disposable Radiolucent foam electrodes
--------	--

ECG Cables

M1733A	8-pin 3-lead ECG Patient Cable w/Snap (AAMI)
M1734A	8-pin 5-lead one piece Cable & Leads, (AAMI)
M1735A	8-pin 3-lead Patient Cable w/Snap (IEC)
M1736A	8-pin 5-lead one piece Cable & Leads (IEC)

SpO₂ Sensors/Cables

(See Chapter 9 for instrument compatibility.)

Miscellaneous

M1781A	Test load for barrel style connector.
M3725A	Test Load for cables/adapters with Heartstream plug connector
M3510A	Defibrillator data card
M3509A	Carrying Case
M3506A	Battery Charger Adapter
M3516A	Sealed Lead Acid (SLA) battery

Paper

40457C	Chemical/Thermal Paper, 10 rolls/case
40457D	Chemical/Thermal Paper, 80 rolls/case

M3535A/M3536A (active) HeartStart MRx Defibrillator/Monitor

Defibrillator Supplies

(See Defibrillator section of the Medical Supplies Reference Guide for detailed listing.)

ECG Monitoring Electrodes

M2202A	Disposable Radiolucent foam electrodes
--------	--

ECG Cables

M3525A	10-Lead ECG Trunk Cable (AAMI/IEC)
989803147691	10-Lead short ECG Trunk Cable (AAMI/IEC)
M3526A	12-pin 3-wire Combination Patient Cable w/Snap (AAMI)
M3528A	12-pin 3-wire Combination Patient Cable w/Snap (IEC)
M3527A	12-pin 7-wire Combination Patient Cable w/Snap (AAMI)
M3529A	12-pin 7-wire Combination Patient Cable w/Snap (IEC)
M5530A	Combiner Plug for 3-wire lead set
M1783A	Sync Cable
M5526A	Sync Cable

SpO₂ Sensors/Cables

(See Chapter 9 for instrument compatibility.)

Microstream CO₂ Monitoring Supplies

M1920A	Adult/pediatric FilterLine set
M1921A	Adult/pediatric FilterLine set
M1923A	Infant/Neonatal CO ₂ Filterline H set
M2520A	Pediatric Smart CapnoLine O ₂
M2522A	Adult Smart CapnoLinePlus O ₂
M2524A	Pediatric Smart CapnoLine CO ₂
M2526A	Adult Smart CapnoLine CO ₂

Disposable Pressure Cuffs (non-sterile)

M4572B	Soft Disposable, infant
M4573B	Soft Disposable, pediatric
M4574B	Soft Disposable, sm adult
M4575B	Soft Disposable, adult
M4576B	Soft Disposable, adult x-long
M4577B	Soft Disposable, lg adult
M4578B	Soft Disposable, lg adult x-long

Reusable Pressure Cuffs

M1571A	Reusable pressure cuff, infant
M1572A	Reusable pressure cuff, pediatric
M1573A	Reusable pressure cuff, small adult
M1574A	Reusable pressure cuff, adult
M1575A	Reusable pressure cuff, large adult
M1576A	Reusable pressure cuff, thigh
M1577A	Reusable pressure cuff kit, 4 smaller cuffs (M1571A, 72A, 73A, 74A)
M1578A	Reusable pressure cuff kit, 4 larger cuffs (M1573A, 74A, 75A, 76A)
M1579A	Reusable pressure cuff kit, (M1571A, 72A, 73A, 74A, 75A, 76A)
M4552A	Antimicrobial reusable cuff, infant
M4553A	Antimicrobial reusable, pediatric

M4554A Antimicrobial reusable, sm adult
 M4555A Antimicrobial reusable, adult
 M4557A Antimicrobial reusable, lg adult

M1598A NIBP Tubing, Adult
 M1599A NIBP Tubing, 3m

Miscellaneous

M1781A Test load for barrel style connector.
 M3725A Test Load for cables/adapters with Heartstream plug connector
 M3510A Defibrillator data card
 M3509A Carrying Case
 M3506A Battery Charger Adapter
 M3516A Sealed Lead Acid (SLA) battery

Paper

40457C Chemical/Thermal Paper, 10 rolls/case
 40457D Chemical/Thermal Paper, 80 rolls/case

M3921A/M3922A/M3923A/M3924A/ M3925A (Obsolete) M3926A/M3927A/M3928A/M3929A (Obsolete) A3 Patient Monitor

ECG Accessories

M3913A ECG Trunk Cable, 3-Lead
 M3914A Snap ECG safety 3-Lead set, IEC
 M3915A Snap ECG safety 3-Lead set, AAMI
 40493E Disposable adult foam ECG electrodes

NIBP Accessories:
 (See Chapter 6 for instrument compatibility.)

SpO₂ Accessories:
 (See Chapter 9 for instrument compatibility.)

Recorder Accessories

M4816A Thermal array paper (10 rolls)
 M4817A Thermal array paper (80 rolls)

Temperature Probes

M3916A Reusable surface skin probe
 M3917A Reusable esophageal/rectal probe

Miscellaneous Accessories

M3919A Canvas bag
 M3920A Snap-on accessory bag

M4504A/M4513A (obsolete) HP Stethos Electronic Stethoscope - 28 inch hose - 40 inch hose

HP Stethos Electronic Stethoscope Replacement Parts

M4504A-60000 Eartips, soft, 12.7mm

M4504A-60010 Eartips, firm, 13.3mm
 M4504A-60020 Diaphragm
 M4504A-60030 Non-chill ring
 M4504A-60040 Battery cover
 M4504A-60050 Replacement 357 batteries
 M4504A-91000 User manual

M4529A (obsolete) Digital Hand-Held Pulse Oximeter

Oximeter Accessories

M4531A Reusable SpO₂ adult finger glove sensor
 M4538A Battery Bypass (105-125 VAC 60Hz)
 M4539A Battery Bypass (208-252 VAC 50/60Hz)
 M4542A Data Cable
 M4541A Protective Boot
 M4529-90000 Operation Manual
 M4529-90004 Home Use Manual

M4530A/M4534A (obsolete) Philips Electronic Stethoscope 20 inch hose 40 inch hose

Philips Electronic Stethoscope Replacement Parts

M4504A-60000 Eartips soft, 12.7mm
 M4504A-60010 Eartips firm, 13.3mm
 M4530A-60020 Diaphragm
 M4530A-60030 Non-chill ring
 M4530A-60040 Battery cover
 M4530A-60050 3V Lithium battery
 M4530A-91000 User's manual

M4735A (active) Heartstream/HeartStart XL Defibrillator/Monitor

Defibrillator Supplies

(See Defibrillator section of the Medical Supplies Reference Guide for detailed listing.)

ECG Monitoring Electrodes

M2202A Disposable Radiolucent foam electrodes

ECG Cables

M1500A 3-lead ECG Trunk Cable (AAMI)
 M1605A 3-lead ECG Patient Cable w/Snaps (AAMI)
 M1510A 3-lead ECG Trunk Cable (IEC)
 M1615A 3-lead ECG Patient Cable w/Snaps (IEC)
 M1520A 5-lead ECG Trunk Cable (AAMI)
 M1625A 5-lead ECG Patient Cable w/Snaps (AAMI)
 M1530A 5-lead ECG Trunk Cable (IEC)
 M1635A 5-lead ECG Patient Cable w/Snaps

M1783A (IEC)
12-pin Sync Cable

SpO₂ Sensors/Cables:
(See Chapter 9 for instrument compatibility.)

Miscellaneous

M1781A Test load for barrel style connector.
M3725A Test Load for cables/adapters with Heartstream plug connector
M3510A Defibrillator data card
M3516A Sealed Lead Acid (SLA) battery
40457C Strip Chart Thermal Paper
40457D Strip Chart Thermal Paper
M4751A Accessory pouch

M1981A 3-lead, one piece cable set,(gr) IEC, ICU
M1510A 3-lead trunk cable, IEC, ICU
M1540A 3-lead trunk cable, AAMI, ICU
M1550C 3-lead trunk cable, IEC, ICU
M1601A 3-lead patient cable, (gr) AAMI
M1603A 3-lead patient cable, (gr) AAMI ICU
M1605A 3-lead patient cable, (sn) AAMI ICU
M1611A 3-lead patient cable, (gr) IEC, OR
M1613A 3-lead patent cable, (gr) IEC ICU
M1615A 3-lead patient cable, (sn) IEC ICU

NIBP Cuffs:
(See Chapter 6 for instrument compatibility.)

Pressure Cuff Interconnect Tubing

M1598B Interconnect tubing for all adult, infant, pediatric cuffs ,4.92' (1.5m) length
M1599B Interconnect tubing for all adult/infant,

860284 (active)
Pagewriter Touch Cardiograph

Cardiography Cables

989803145401 USB Patient Data Cable - standard

Cardiography Patient Cables

989803129161 Complete lead set, AAMI
989803129191 Complete lead set, IEC
989803129221 Long complete lead set, IEC

Cardiography Replacement Leads & Access.

989803129141 Limb lead set, AAMI
989803129151 Chest lead set, AAMI
989803129171 Limb lead set, IEC
989803129181 Chest lead set, IEC
989803129201 Long limb lead set, IEC
989803129211 Long limb lead set, IEC

Other Supplies

989803129131 Battery
989803129231 Alligator clip adapters, AAMI
989803129241 Alligator clip adapters, IEC

Paper

M2481A PageWriter thermal paper, 8.5x11
M2483A PageWriter paper with header, A4
M2485A Anti-fade PageWriter paper, 8.5x11
M2486A Anti-fade PageWriter paper, A4

Electrodes

(See Electrode section of the Medical Supplies Reference Guide for detailed listing.)

862474, 862475, 862478, 862479, 862482, 862483 (obsolete)
C3 Monitor

ECG Accessories

40493D/E Disposable adult ECG foam electrode
M1970A 3-lead, one piece cable set, (gr) AAMI
M1972A 3-lead, one piece cable set, (snap)IEC
M1980A 3-lead, one piece cable set, (gr)IEC, OR

SpO₂ Sensors:
(See Chapter 9 for instrument compatibility.)

Temperature Probes

Reusable Temperature Probes

21075A General purpose probe
21076A Small flexible vinyl probe (infant/pedi)
21078A Tape-on surface temp probe

Disposable Temperature Probes

M1837A Esophageal/rectal temp probes
21090A Esophageal/rectal temp probes
21091A Skin surface temp probe
21082A Temp probe adapter cable
21082A Temp probe adapter cable

CO₂ Accessories

Non-Intubated FilterLines

M2526A Smart CapnoLine Plus, Adult
M2524A Smart CapnoLine, Pediatric
M2522A Smart CapnoLine Plus O₂, Adult
M2520A Smart CapnoLine O₂, Pediatric
M4680A CapnoLine H O₂, Adult
M4681A CapnoLine H O₂, Pediatric
M4686A NIV Line, Adult
M4687A NIV Line, Pediatric
M4689A CapnoLine H, Adult
M4690A CapnoLine H, Pediatric
M4691A CapnoLine H, Infant/Neonatal

Exhaust Tubing

M1015-40001 Tubing

Intubated FilterLine Sets (includes FilterLine & Airway Adapter)

M1920A Adult/Pedi FilterLine Set
M1921A Adult/Pedi FilterLine H set
M1923A Infant FilterLine H set

Recorder Accessories

M4816A 10 rolls paper
M4817A 80 rolls paper

Miscellaneous Accessories

M3919A Canvas bag
M3920A Snap-on Accessory Bag

**860286, 860287, 860288, 860290 (active)
PageWriter Trim I, II, III, Rx****Cardiography Patient Cables**

989803129161	Complete lead set, AAMI
989803129191	Complete lead set, IEC
989803129221	Long complete lead set, IEC

Cardiography Replacement Leads & Access.

989803129141	Limb lead set, AAMI
989803129151	Chest lead set, AAMI
989803129171	Limb lead set, IEC
989803129181	Chest lead set, IEC
989803129201	Long limb lead set, IEC
989803129211	Long limb lead set, IEC
989803129221	Long Complete lead set, IEC

Other Supplies

989803130151	Battery
989803129231	Alligator clip adapters, AAMI
989803129241	Alligator clip adapters, IEC

Paper

M3707A	PageWriter thermal paper, 8.5x11
M3708A	PageWriter paper with header, A4

Electrodes

40490E	Reusable Welsh electrodes
40421A	Welsh electrode w/push-in connector
40494E	Limb clamp electrode, clothespin type
14030A	rubber strap for 40494E
40420A	Snap foam electrode
13943B	Tab-style solid gel electrode
M2253A	Tab-style solid gel electrode
13944B	Snap-style wet gel foam electrode
M2254A	Tab electrode adapter, 1/8", 4mm leads
40431B	Alligator clip adapter
40498E	Snap lead adapter, IEC
40475A	Snap lead adapter

860295 StressVue Stress System (active)**Patient Cables and Accessories**

989803136951	Standard patient 10-lead set, AAMI
989803136961	Standard patient 10-lead set, IEC
989803137661	Large patient 10-lead set, AAMI
989803137671	Large patient 10-lead set, IEC
989803137961	StressVue pouch, wireless
989803137971	StressVue pouch, wired
989803137011	Paper, U.S. format
989803143031	Paper, A4
13942E	Stress testing electrodes

862146 ICG Hemodynamic Measurement (active)**Reusable Pressure Cuffs**

M4555A	Antimicrobial reusable, adult
M4556A	Antimicrobial reusable, adult x-long
M4557A	Antimicrobial reusable, lg adult
M4558A	Antimicrobial lg adult, x-long
NIBP Tubing	M3918A

ICG Supplies

M4620A	ICG/vECG cable
989803129801	ICG sensors
989803138131	Recorder paper

**863051, 863052, 863053, 863054 (Obsolete)
C1 Patient Monitor (SureSigns)****NIBP :**

(See Chapter 6 for instrument compatibility.)

M3918A	NIBP Tubing
--------	-------------

ECG Accessories

M3913A	Trunk cable, 3-lead
M3914A	3-lead set, IEC
M3915A	3-lead set, AAMI
40493E	Electrodes, foam adult

SpO₂:

(See Chapter 9 for instrument compatibility.)

Temperature

M4821A	Oral temp probe
M4822A	Rectal temp probe
M4823A	Temp probe covers

Recorder

M4816A/M4817A	Recording paper
---------------	-----------------

**863055, 863056, 863057, 863058 (obsolete)
863059, 863060, 863061, 863062
VS1 Vital Signs Monitor (SureSigns)****NIBP :**

(See Chapter 6 for instrument compatibility.)

989803136931	NIBP Tubing, adult/pediatric
989803136941	NIBP Tubing, neonatal

SpO₂:

(See Chapter 9 for instrument compatibility.)

Temperature

989803136901	Oral temp probe
989803136921	Rectal temp probe
989803136911	Temp probe covers

Recorder

989803136981 Recording paper

**863063, 863064, 863065, 863066,
863068 (active)
VM3, VM4, VM6, VM8 Vital Signs Monitor**

SpO₂ :
(See Chapter 9 for instrument compatibility.)

NIBP:
(See Chapter 6 for instrument compatibility.)

40493D/E Electrodes

Cable Sets:

989803143181 3-Lead AAMI
989803143201 5-Lead AAMI
989803143171 3-Lead IEC
989803143191 5-Lead IEC

Predictive Temp (VM4):
989803143381 Oral
989803143391 Rectal
M4823A Cover

Continuous Temp (VM6-VM8):

M1837A Esoph/Rectal Disposable
21091A Skin Surface Disposable
21093A Esoph/Steth Disposable
M21082A/B Cable
21075A Esoph/Rectal Reus.
21076A Esoph/Rectal Reus.
21078A Skin Surface
989803136891 Paper
989803144631 Battery

Microstream CO₂ (VM8):

M1920A Adult/Pedi FilterLine set
M1921A Adult/Pedi FilterLine H
M1923A Inf/Neo FilterLine H
M2520A Pedi Smart CapnoLine O2
M2522A Adult Smart CapnoLine+ O2
M2524A Pedi Smart CapnoLine
M2526A Adult Smart CapnoLine+

**862108 Philips Telemetry System
M2601B Transmitter (active)**

Cables and Lead Sets

989803151991 3-lead, gray wire, snap, AAMI
989803151971 3-lead, gray wire, grabber, AAMI
989803152071 5-lead, multi-color wire, snap, AAMI
989803152051 5-lead, multi-color, grabber, AAMI
989803152001 3-lead, gray wire, snap, IEC
989803151981 3-lead, gray wire, grabber, IEC
989803152081 5-lead, multi-color wire, snap, IEC
989803152061 5-lead, multi-color, grabber, IEC
M1949A Trunk Cable, AAMI/IEC

989803143481 PWD Tether cable
989803143491 TeleMon Tether cable
989803146911 MP5 Tether cable

SpO₂ Sensors:
(See Chapter 9 for instrument compatibility.)

Miscellaneous M2601B Supplies

989803137831 Transmitter pouch, (50)
989803140371 Transmitter pouch, (200)
989803140401 Single ECG alignment guide, untethered
989803140411 Single ECG alignment guide, tethered
989803140421 Double ECG alignment guide, untethered
989803140431 TeleMon/Svc Port Cover, ECG only
989803140451 TeleMon/Svc Port Cover, ECG/SpO₂ only
989803140441 SpO₂ Connector Cover
989803153031 3-lead shower shields
989803153041 5-lead shower shields
989803153051 6-lead shower shields

**862439, 862231 Philips IntelliVue TRx and
TRx+ Transceivers: M4841A and M4851A**

ECG Leadsets

989803151991 3-lead, gray wire, snap, AAMI
989803151971 3-lead, gray wire, grabber, AAMI
989803152071 5-lead, multi-color wire, snap, AAMI
989803152051 5-lead, multi-color, grabber, AAMI
989803152151 6-lead, multi-color, snap, AAMI
989803152131 6-lead, multi-color, grabber, AAMI
989803152001 3-lead, gray wire, snap, IEC
989803151981 3-lead, gray wire, grabber, IEC
989803152081 5-lead, multi-color wire, snap, IEC
989803152061 5-lead, multi-color, grabber, IEC
989803152161 6-lead, multi-color, snap, IEC
989803152141 6-lead, multi-color, grabber, IEC
M1949A Trunk cable, AAMI/IEC
989803143481 PWD tether cable
989803143491 TeleMon Tether cable
989803146911 MP5 Tether cable
989803140441 SpO₂ Connector Cover

SpO₂ Sensors:
(See Chapter 9 for Instrument Compatibility.)

Miscellaneous Supplies

989803137831 Transmitter pouch, (50)
989803140371 Transmitter pouch, (200)
989803140401 Single ECG alignment guide, untethered
989803140411 Single ECG alignment guide, tethered
989803140421 Double ECG alignment guide, untethered
989803140431 TeleMon/Svc Port Cover, ECG only
989803140451 TeleMon/Svc Port Cover, ECG/SpO₂
989803140441 SpO₂ Connector Cover
989803153031 3-lead shower shields
989803153041 5-lead shower shields
989803153051 6-lead shower shields

M8105A IntelliVue MP5 Monitor (active)**Electrodes:**

40493D/E Adult monitoring electrodes (300)

Cables and Leads

989803143181 3-Lead AAMI
 989803143201 5-Lead AAMI
 989803143171 3-Lead IEC
 989803143191 5-Lead IEC

M1669A ECG 3-ld safety connector trunk cable, AAMI/IEC
 M1668A ECG 5-ld safety connector trunk cable, AAMI/IEC
 M1663A ECG 10-ld (5+5) safety connector trunk cable, AAMI/IEC
 M1665A ECG 10-ld (6+4) safety connector trunk cable.
 M1675A OR 3-lead set, grabber, AAMI
 M1671A Shielded 3-lead set, grabber, safety, AAMI
 M1673A Shielded 3-lead set, snap, safety, AAMI
 M1622A Unshielded 3-lead set, safety, AAMI
 M1624A Unshielded 3-lead set, safety, AAMI
 M1678A OR 3-lead set, grabber, safety, IEC
 M1672A Shielded 3-lead set, grabber, safety, IEC
 M1674A Shielded 3-lead set, snap, safety, IEC
 M1626A Unshielded 3-lead set, safety, IEC
 M1621A Shielded OR 5-lead grabber, safety, AAMI
 M1968A Shielded 5-lead set, grabber, safety, AAMI
 M1644A Shielded 5-lead set snap, safety, AAMI
 M1647A Unshielded 5-lead set, safety, AAMI
 M1974A Shielded OR 5-lead set, grabber, safety, IEC
 M1971A Shielded 5-lead set, grabber, safety, IEC
 M1645A Shielded 5-lead set snap, safety, IEC
 M1648A Unshielded 5-lead set, safety, IEC
 M1680A Shielded 6-lead grabber, safety, AAMI
 M1682A Shielded 6-lead snap, safety, AAMI
 M1684A Shielded OR 6-lead grabber, safety, AAMI
 M1532A Shielded 4-lead, snap, AAMI
 M1537A Shielded 4-lead, grabber, AAMI
 M1557A Shielded OR 4-lead, grabber, AAMI
 M1681A Shielded 6-lead grabber, IEC
 M1683A Shielded 6-lead snap, IEC
 M1685A Shielded OR 6-lead grabber, IEC
 M1533A Shielded 4-lead grabber, IEC
 M1538A Shielded 4-lead snap, IEC
 M1558A Shielded OR 4-lead grabber, IEC

ECG Safety Cable Accessories

M1503A Organizer for shielded 3-lead sets
 M1504A Organizer for shielded 5-lead sets
 M1664A Organizer for shielded 4-lead sets
 M1679A Organizer for shielded 6-lead sets
 M1636A Organizer for unshielded 3-lead sets
 M1638A Organizer for unshielded 5-lead sets
 M1509A Bedsheet clip, repositionable, 3/pack
 M2598A 3-lead combiner shield
 M2599A 5-lead combiner shield
 M2281A Patient cable organizer, 8/pack

989803143481 PWD tether cable
 989803146911 MP5 tether cable

Predictive Temperature

989803143381 Oral Temp Probes with covers
 989803143391 Rectal Temp Probes with covers

**CO2 Monitoring:
Mainstream**

M2501A Mainstream CO2 Sensor
 M2513A Reusable adult airway adapter
 M2516A Reusable infant airway adapter
 M2533A Disposable adult airway adapter
 M2536A Disposable infant airway adapter

Sidestream

M2741A CO2 Sidestream Sensor
 M2756A CO2 oral-nasal cannula, adult
 M2757A CO2 oral-nasal cannula, pediatric
 M2772A Airway adapter set H ET >4.0mm
 M2773A Airway adapter set H ET <4.0mm
 M2744A CO₂ nasal, adult
 M2745A CO₂ nasal, pediatric
 M2746A CO₂ nasal, infant
 M2750A CO₂/O₂ nasal, adult
 M2751A CO₂/O₂ nasal, pediatric
 M2760A CO₂/O₂ oral-nasal, adult
 M2761A CO₂/O₂ oral-nasal, pediatric

Invasive Pressure

CPJ840J6 Memscap reusable pressure transducer
 CPJ84022 Disposable dome
 CPJ84046 Transducer holder
 CPJ84447 IV pole mount
 M1567A Disposable pressure kit, single ch. (non-US)
 M1568A Disposable pressure kit, dual ch. (non-US)
 M1634A Cable
 M2271A Transducer holder
 M2272A IV pole mount

Non-Invasive Blood Pressure

(See Chapter 6 for instrument compatibility)

SpO₂ Sensors

(See Chapter 9 for instrument compatibility)

M8102A IntelliVue MP2 Monitor (active)**Electrodes:**

40493D/E Adult monitoring electrodes (300)

Cables and Leads

989803143181 3-Lead AAMI
 989803143201 5-Lead AAMI
 989803143171 3-Lead IEC
 989803143191 5-Lead IEC

M1669A ECG 3-ld safety connector trunk cable, AAMI/IEC
 M1668A ECG 5-ld safety connector trunk cable, AAMI/IEC

M1663A	ECG 10-ld (5+5) safety connector trunk cable, AAMI/IEC
M1665A	ECG 10-ld (6+4) safety connector trunk cable.
M1675A	OR 3-lead set, grabber, AAMI
M1671A	Shielded 3-lead set, grabber, safety, AAMI
M1673A	Shielded 3-lead set, snap, safety, AAMI
M1622A	Unshielded 3-lead set, safety, AAMI
M1624A	Unshielded 3-lead set, safety, AAMI
M1678A	OR 3-lead set, grabber, safety, IEC
M1672A	Shielded 3-lead set, grabber, safety, IEC
M1674A	Shielded 3-lead set, snap, safety, IEC
M1626A	Unshielded 3-lead set, safety, IEC
M1621A	Shielded OR 5-lead grabber, safety, AAMI
M1968A	Shielded 5-lead set, grabber, safety, AAMI
M1644A	Shielded 5-lead set snap, safety, AAMI
M1647A	Unshielded 5-lead set, safety, AAMI
M1974A	Shielded OR 5-lead set, grabber, safety, IEC
M1971A	Shielded 5-lead set, grabber, safety, IEC
M1645A	Shielded 5-lead set snap, safety, IEC
M1648A	Unshielded 5-lead set, safety, IEC
M1680A	Shielded 6-lead grabber, safety, AAMI
M1682A	Shielded 6-lead snap, safety, AAMI
M1684A	Shielded OR 6-lead grabber, safety, AAMI
M1532A	Shielded 4-lead, snap, AAMI
M1537A	Shielded 4-lead, grabber, AAMI
M1557A	Shielded OR 4-lead, grabber, AAMI
M1681A	Shielded 6-lead grabber, IEC
M1683A	Shielded 6-lead snap, IEC
M1685A	Shielded OR 6-lead grabber, IEC
M1533A	Shielded 4-lead grabber, IEC
M1538A	Shielded 4-lead snap, IEC
M1558A	Shielded OR 4-lead grabber, IEC

ECG Safety Cable Accessories

M1503A	Organizer for shielded 3-lead sets
M1504A	Organizer for shielded 5-lead sets
M1664A	Organizer for shielded 4-lead sets
M1679A	Organizer for shielded 6-lead sets
M1636A	Organizer for unshielded 3-lead sets
M1638A	Organizer for unshielded 5-lead sets
M1509A	Bedsheet clip, repositionable, 3/pack
M2598A	3-lead combiner shield
M2599A	5-lead combiner shield
M2281A	Patient cable organizer, 8/pack

CO₂ Monitoring: Mainstream

M2501A	Mainstream CO ₂ Sensor
M2513A	Reusable adult airway adapter
M2516A	Reusable infant airway adapter
M2533A	Disposable adult airway adapter
M2536A	Disposable infant airway adapter

Sidestream

M2741A	CO ₂ Sidestream Sensor
M2756A	CO ₂ oral-nasal cannula, adult
M2757A	CO ₂ oral-nasal cannula, pediatric
M2772A	Airway adapter set H ET >4.0mm
M2773A	Airway adapter set H ET <4.0mm
M2744A	CO ₂ nasal, adult
M2745A	CO ₂ nasal, pediatric
M2746A	CO ₂ nasal, infant
M2750A	CO ₂ /O ₂ nasal, adult
M2751A	CO ₂ /O ₂ nasal, pediatric

M2760A	CO ₂ /O ₂ oral-nasal, adult
M2761A	CO ₂ /O ₂ oral-nasal, pediatric
M2776A	Intubated, straight sample line, 12 hrs.
M2777A	Intubated, straight sample line H, 120 hrs.
M2768A	Airway adapter non-humidified ET >4mm

Invasive Pressure

CPJ840J6	Memscap reusable pressure transducer
CPJ84022	Disposable dome
CPJ84046	Transducer holder
CPJ84447	IV pole mount
M1567A	Disposable pressure kit, single ch. (non-US)
M1568A	Disposable pressure kit, dual ch. (non-US)
M1634A	Cable
M2271A	Transducer holder
M2272A	IV pole mount

Temperature Accessories

Reusable Temperature Probes

21075A	General purpose probe
21076A	Small flexible vinyl probe (infant/pedi)
21078A	Tape-on surface temp probe

Disposable Temperature Probes

M1837A	Esophageal/rectal temp probes
21091A	Skin surface temp probe
21093A	Esophageal/stethoscope probe
21094A	Esophageal/stethoscope probe
21095A	Esophageal/stethoscope probe
M2255A	Foley catheter probe
21096A	Foley catheter probe
21097A	Foley catheter probe
21082A	Temp probe adapter cable
21082A	Temp probe adapter cable

Non-Invasive Blood Pressure

(See Chapter 6 for instrument compatibility)

SpO₂ Sensors

(See Chapter 9 for instrument compatibility)

Miscellaneous

M4607A	Battery
989803153441	Carrying Strap
989803157171	Anti-Slip Pad

M3002A MMS X2

Electrodes:

40493D/E Adult monitoring electrodes (300)

Cables and Leads

M1669A	ECG 3-ld safety connector trunk cable, AAMI/IEC
M1668A	ECG 5-ld safety connector trunk cable, AAMI/IEC
M1663A	ECG 10-ld (5+5) safety connector trunk cable, AAMI/IEC
M1665A	ECG 10-ld (6+4) safety connector trunk cable.
M1675A	OR 3-lead set, grabber, AAMI

M1671A	Shielded 3-lead set, grabber, safety, AAMI
M1673A	Shielded 3-lead set, snap, safety, AAMI
M1622A	Unshielded 3-lead set, safety, AAMI
M1624A	Unshielded 3-lead set, safety, AAMI
M1678A	OR 3-lead set, grabber, safety, IEC
M1672A	Shielded 3-lead set, grabber, safety, IEC
M1674A	Shielded 3-lead set, snap, safety, IEC
M1626A	Unshielded 3-lead set, safety, IEC
M1621A	Shielded OR 5-lead grabber, safety, AAMI
M1968A	Shielded 5-lead set, grabber, safety, AAMI
M1644A	Shielded 5-lead set snap, safety, AAMI
M1647A	Unshielded 5-lead set, safety, AAMI
M1974A	Shielded OR 5-lead set, grabber, safety, IEC
M1971A	Shielded 5-lead set, grabber, safety, IEC
M1645A	Shielded 5-lead set snap, safety, IEC
M1648A	Unshielded 5-lead set, safety, IEC
M1680A	Shielded 6-lead grabber, safety, AAMI
M1682A	Shielded 6-lead snap, safety, AAMI
M1684A	Shielded OR 6-lead grabber, safety, AAMI
M1532A	Shielded 4-lead, snap, AAMI
M1537A	Shielded 4-lead, grabber, AAMI
M1557A	Shielded OR 4-lead, grabber, AAMI
M1681A	Shielded 6-lead grabber, IEC
M1683A	Shielded 6-lead snap, IEC
M1685A	Shielded OR 6-lead grabber, IEC
M1533A	Shielded 4-lead grabber, IEC
M1538A	Shielded 4-lead snap, IEC
M1558A	Shielded OR 4-lead grabber, IEC

CO₂ Monitoring: Mainstream

M2501A	Mainstream CO ₂ Sensor
M2513A	Reusable adult airway adapter
M2516A	Reusable infant airway adapter
M2533A	Disposable adult airway adapter
M2536A	Disposable infant airway adapter

Sidestream

M2741A	CO ₂ Sidestream Sensor
M2756A	CO ₂ oral-nasal cannula, adult
M2757A	CO ₂ oral-nasal cannula, pediatric
M2772A	Airway adapter set H ET >4.0mm
M2773A	Airway adapter set H ET <4.0mm
M2744A	CO ₂ nasal, adult
M2745A	CO ₂ nasal, pediatric
M2746A	CO ₂ nasal, infant
M2750A	CO ₂ /O ₂ nasal, adult
M2751A	CO ₂ /O ₂ nasal, pediatric
M2760A	CO ₂ /O ₂ oral-nasal, adult
M2761A	CO ₂ /O ₂ oral-nasal, pediatric
M2776A	Intubated, straight sample line, 12 hrs.
M2777A	Intubated, straight sample line H, 120 hrs.
M2768A	Airway adapter non-humidified ET >4mm

Invasive Pressure

CPJ840J6	Memscap reusable pressure transducer
CPJ84022	Disposable dome
CPJ84046	Transducer holder
CPJ84447	IV pole mount
M1567A	Disposable pressure kit, single ch. (non-US)
M1568A	Disposable pressure kit, dual ch. (non-US)
M1634A	Cable
M2271A	Transducer holder
M2272A	IV pole mount

Temperature Accessories

Reusable Temperature Probes

21075A	General purpose probe
21076A	Small flexible vinyl probe (infant/pedi)
21078A	Tape-on surface temp probe

Disposable Temperature Probes

M1837A	Esophageal/rectal temp probes
21091A	Skin surface temp probe
21093A	Esophageal/stethoscope probe
21094A	Esophageal/stethoscope probe
21095A	Esophageal/stethoscope probe
M2255A	Foley catheter probe
21096A	Foley catheter probe
21097A	Foley catheter probe
21082A	Temp probe adapter cable
21082A	Temp probe adapter cable

Non-Invasive Blood Pressure

(See Chapter 6 for instrument compatibility)

SpO₂ Sensors

(See Chapter 9 for instrument compatibility)

Miscellaneous

M4607A	Battery
989803153441	Carrying Strap
989803157171	Anti-Slip Pad

Index by Product Number

- 05-10000 Pad adapter (Medtronic Physio Control), 12-4, 12-14
05-10100 Pad adapter (Zoll), 12-4, 12-14
05-10200 adapter (HP, Agilent, Philips, Laerdal), 12-4, 12-14
07-10900 Reusable AED adult training electrode pads, 12-20
07-11000 AED Trainer 2 carrying case, 12-20
13901A Nafion sample tube, 8-10
13901A Reusable Nafion sample tube, 8-6
13902A Elbow airway adapter, 8-6, 8-10
13904A Bacteria filter, 8-6, 8-10
13905A Hybrid Nafion/polyethylene sample tube, 8-6
13905A Nafion/polyethylene sample tube, 8-10
13906A Calibration gas, 8-10
13907A Calibration tube, 8-10
13941E Pre-gel electrode, 1-3
13942E Pre-gel electrode, 1-3
13943B Tab electrode, 1-7
13944B Foam electrode, 1-7
13950B Wet-gel electrode, 1-6
13951C Cloth electrode, 1-6
13952A Neonatal electrode, 1-4
13952B Neonatal electrode, 1-5
13952D Neonatal electrode, 1-4
13952E Neonatal electrode, 1-5
13953A Neonatal electrode, 1-4
13953B Neonatal electrode, 1-5
13953D Neonatal electrode, 1-4
13953E Neonatal electrode, 1-5
13955C Cloth electrode, 1-6
14030A Limb electrode strap, 1-10
14328A Fetal monitoring belt, 4-7
14363A Reusable pediatric airway adapter, 8-3
14455A Ice bucket, 13-2
1500-0628 Fetal monitoring belt, 4-9
1500-0642 Fetal monitoring belt, 4-8
150643 Fetal monitoring belt, 4-9
15133D Fetal scalp electrode, 4-4
15133E Fetal scalp electrode, 4-4
15155-43101 Belt guide, 4-10
15209-60010 TcPO₂/CO₂ accessory kit, 8-2
15209-60020 TcPO₂/CO₂ fixation kit, 8-2
15210-60010 CAL 1 gas cylinders, 8-2
15210-60020 CAL 2 gas cylinders, 8-2
15210-64010 CAL 1 gas cylinders, 8-2
15210-64020 CAL 2 gas cylinders, 8-2
15244A Remote start and cable, 13-2
21075A Reusable temp probe, 7-6
21076A Reusable temp probe, 7-6
21078A Reusable temp probe, 7-6
21082A Temp probe cable, 7-5
21082B Temp probe cable, 7-5
21090A Disposable temp probe, 7-2
21091A Disposable temp probe, 7-3
21093A Disposable temp probe, 7-3
21094A Disposable temp probe, 7-3
21095A Disposable temp probe, 7-3
21096A Disposable temp probe, 7-5
21097A Disposable temp probe, 7-5
21110A TEE transducer basin, 10-3
23001A Injectate temp probe, 13-2
23001B Injectate temp probe, 13-2
23002A Ice bath temp probe, 13-2
280-100-C25 Stethoscope small eartips, 11-7
280-100-C26 Stethoscope large eartips, 11-7
280-100-C27 Stethoscope adult chest kit, 11-7
280-100-C30 Stethoscope reconditioning kit, 11-7
280-100-C31 Stethoscope reconditioning kit, 11-7
40400A NIBP cuff kit, 6-12
40400B NIBP cuff kit, 6-12
40401A NIBP cuff, infant, 6-11
40401B NIBP cuff, pedi, 6-11
40401C NIBP cuff, adult, 6-11
40401D NIBP cuff, lg adult, 6-11
40401E NIBP cuff, thigh, 6-11
40418A Welsh electrode, 1-8
40419A Replacement Welsh bulbs, 1-8
40420A Foam electrode, 1-7
40421A Welsh electrode, 1-8
40422A Replacement Welsh bulbs, 1-8
40424A Limb plate electrode, 1-9
40431B Alligator clip adapters, 3-43
40432B Alligator clip adapters, 3-43
40453A Chemical/thermal paper, 2-9
40455A Telemetry battery, 11-3
40457C Chemical/thermal paper, 2-9
40457D Chemical/thermal paper, 2-9
40458A Thermal imaging paper, 2-12
40469A Thermal array Z-fold paper, 2-6
40470A Fetal paper, 2-7
40475A Lead adapter, 3-44
40477B Thermal array paper, 2-6
40479A Strip chart paper, 2-12
40483A US transmission gel, 4-15
40483B US transmission gel, 4-15
40488A V24/V26 battery, 11-2
40489E Pre-gel electrode, 1-3
40490E Welsh electrode, 1-8
40491E Limb plate electrode, 1-9
40493D Foam electrode, 1-2
40493E Foam electrode, 1-2
40494E Limb clamp electrode, 1-9
40498E Lead adapter, 3-44
68-PCHAT AED Fast Response Kit, 12-14
861276 HeartStart Event Review Pro, 12-11
861276 HS Event Review Pro Software, 12-16
861306 HeartStart FRx Trainer, 12-22
861311 A01 HeartStart Review Express Software, 12-16
9270-0484 Fetal paper, 2-7
9270-0485 Fetal paper, 2-7
9270-0630-050 Fetal paper, 2-7
9300-0768-050 Telemetry pouch, 11-4
9300-0768-200 Telemetry pouch, 11-4
9898031 03861 bedsheet clip, 3-23
9898031 29141 PW Touch/Trim replacement leads, 3-40
9898031 29151 PW Touch/Trim replacement leads, 3-40
9898031 29161 PW Touch/Trim replacement leads, 3-40
9898031 36891 Thermal array paper, 2-6
9898031 36931 NIBP tubing, 6-17
9898031 36951 StressVue lead set, 3-39
9898031 36961 StressVue lead set, 3-39
9898031 37661 StressVue lead set, 3-39
9898031 37671 StressVue lead set, 3-39
9898031 38171 Chemical/thermal paper, 2-9
9898031 38181 Chemical/thermal paper, 2-9
9898031 43391 Rectal temp probe, 7-8
9898031 45401 PW Touch USB cable, 3-38
9898031 47711 HeartStart data card, 12-11
9898031 48811 Solid gel electrode, 1-2
9898031 48841 cable management kit, 3-23
9898031 48861 trunk cable covers, 3-23
9898031 48931 PW Touch Upgrade Kit, AAMI, 3-40
9898031 49901 Pediatric tab electrode, 1-7
989803129131 PageWriter Touch battery, 11-2
989803129171 PW Touch/Trim replacement leads, 3-40
989803129181 PageWriter Touch/Trim replacement leads, 3-40
989803129191 PageWriter Touch/Trim replacement leads, 3-40
989803129201 PW Touch/Trim long replacement leads, 3-41
989803129211 PW Touch/Trim long replacement leads, 3-41
989803129221 PW Touch/Trim long replacement leads, 3-41
989803129231 Alligator clip adapter, 3-43
989803129241 Alligator clip adapter, 3-43
989803130151 PageWriter Trim battery, 11-2
989803133171 Temp. Control Case, 12-18
989803136291 Battery-Aviation-LiMnO₂, 12-13
989803136301 Battery-Aviation-LiMnO₂, 12-13
989803136531 Defib Cabinet-Basic, 12-18
989803136651 Digitrak Plus pouch, 11-5
989803136901 Oral temp probe, 7-7

- 989803136911 Rectal temp probe, 7-7
 989803136921 Temp probe covers, 7-7
 989803136941 NIBP tubing, 6-22
 989803137011 StressVue paper, 2-11
 989803137631 Fetal spiral electrode, 4-2
 989803137641 Fetal double spiral electrode, 4-2
 989803137651 DECG legplate adapter cable, 4-3
 989803137791 DECG legplate adapter cable, 4-3
 989803137811 DECG legplate adapter cable, 4-3
 989803137831 Telemetry transceiver pouch, 11-4
 989803137961 StressVue pouch, 11-5
 989803137971 StressVue pouch with belt, 11-5
 989803138131 Thermal array paper, ICG, 2-6
 989803139251 FRx Case, 12-18
 989803139261 SMART Pads II, 12-12
 989803139271 Training Pads II, 12-21
 989803139311 Infant/Child Key, 12-14
 989803139771 Attachment electrode, 4-3
 989803140231 LNOP Adt sensor, 9-8
 989803140261 LNOP Pdt sensor, 9-8
 989803140271 LNOP Neo sensor, 9-8
 989803140281 LNOP SofTouch NeoPt sensor, 9-8
 989803140291 LNOP Neo-L sensor, 9-8
 989803140301 LNOP SofTouch Neo Pt-L sensor, 9-8
 989803140311 LNOP Inf-L sensor, 9-8
 989803140321 Reusable SpO₂ LNOP sensor, 9-5
 989803140331 Reusable SpO₂ LNOP DCIP sensor, 9-5
 989803140341 Reusable SpO₂ LNOP TC-I sensor, 9-5
 989803140351 Poseys for LNOP SofTouch NeoPt sensors, 9-8
 989803140361 Replacement tapes, 9-8
 989803140371 Transceiver pouch, 11-4
 989803140431 TeleMon service port protective cover, 11-4
 989803140441 SpO₂ connector protective cover, 11-4
 989803140451 TeleMon service port protective cover, 11-4
 989803141811 HS Event Review Software, 12-16
 989803142521 HeartStart transfer station, 12-11
 989803143031 StressVue paper, 2-11
 989803143041 HeartStart PDA Software, 12-16
 989803143051 HeartStart Capture-PDA Software, 12-16
 989803143171 SureSigns low cost 3-lead set, 3-26
 989803143181 SureSigns low cost 3-lead set, 3-26
 989803143191 SureSigns low cost 5-lead set, 3-26
 989803143201 SureSigns low cost 5-lead set, 3-26
 989803143381 Oral temp probe, 7-8
 989803143401 Belt clip, 4-10
 989803143411 Event marker, 4-15
 989803143481 PWD tether cable, 3-30
 989803143491 Telemon tether cable, 3-30
 989803143581 BIS Sensor Pediatric, 8-12
 989803143931 IUP connector cable, 4-11
 989803143961 BIS SRS dispenser, 8-12
 989803144351 StressVue pouch, 11-5
 989803144631 SureSigns battery, 11-3
 989803146911 MP5 tether cable, 3-30
 989803147691 10-Lead Trunk Cable, Defib, 3-36
 989803147721 HeartStart data card, 12-11
 989803148221 LNCS adapter cable, 9-6
 989803148231 LNCS Adt sensor, 9-9
 989803148241 LNCS Pdt sensor, 9-9
 989803148251 LNCS Inf-L sensor, 9-9
 989803148261 LNCS Neo sensor, 9-9
 989803148271 LNCS Neo-L sensor, 9-9
 989803148281 Reusable SpO₂ LNCS DC-I sensor, 9-5
 989803148291 Reusable SpO₂ LNCS DC-IP sensor, 9-5
 989803148301 Reusable SpO₂ LNCS TC-I sensor, 9-5
 989803148311 Reusable SpO₂ LNCS TF-I sensor, 9-5
 989803148881 16-lead spare parts kit, 3-43
 989803149181 PW Touch Upgrade Kit, IEC, 3-40
 989803149191 PW Touch/Trim long replacement leads, 3-41
 989803150291 FR2+ Instructor's Training Toolkit NTSC, 12-21
 989803151051 Medical grade DVDs, 11-5
 989803151601 Cuff caps, single hose, 6-18
 989803151611 Cuff caps, double hose, 6-18
 989803151971 Telemetry 3-lead set, AAMI, 3-28
 989803151981 Telemetry 3-Lead set, IEC, 3-29
 989803151991 Telemetry 3-lead set, AAMI, 3-28
 989803152001 Telemetry 3-Lead set, IEC, 3-29
 989803152051 Telemetry 5-lead set, AAMI, 3-28
 989803152061 Telemetry 5-Lead set, IEC, 3-29
 989803152071 Telemetry 5-lead set, AAMI, 3-28
 989803152081 Telemetry 5-Lead set, IEC, 3-29
 989803152131 Telemetry 6-lead set, AAMI, 3-28
 989803152141 Telemetry 6-Lead set, IEC, 3-29
 989803152151 Telemetry 6-lead set, AAMI, 3-28
 989803152161 Telemetry 6-Lead set, IEC, 3-29
 989803153441 Carrying strap, 11-5
 989803157171 Anti-slip pad, 11-5
 ACT-IR, Infrared data cable, HS1, 12-15
 BT1 ForeRunner lithium manganese dioxide battery, 12-13
 CBD20257 Stress chart paper, 2-10
 CPJ84022 Sterile domes, 5-2
 CPJ84022 Sterile domes for pressure transducer, 4-12
 CPJ84026 Line sets, 5-2
 CPJ84046 Transducer holder, 4-12, 5-2
 CPJ840J5 IUP pressure transducer, 4-12
 CPJ840J5 Memscap IUP Pressure Transducer, 5-2
 CPJ840J6 Memscap blood pressure transducer, 5-2
 CPJ84447 IV pole mount, 5-2
 DP2 Self-adhesive adult electrode pads, 12-12
 DP6 Self-adhesive adult electrode pads, 12-12
 M1020-61100 LNOP adapter cable, 9-6
 M1020-61102 LNOP adapter cable, 9-6
 M1131A Disposable SpO₂ finger sensor, adult/pediatric, 9-7
 M1132A Disposable SpO₂ infant sensor, 9-7
 M1133A Disposable SpO₂ neonatal sensor, 9-7
 M1191A Reusable SpO₂ sensor, adult, 9-2
 M1191AL Reusable SpO₂ sensor, adult, 9-2
 M1191B Reusable SpO₂ sensor, adult, 9-2
 M1191BL Reusable SpO₂ sensor, adult, 9-2
 M1191T Reusable SpO₂ sensor, adult, 9-3
 M1192A Reusable SpO₂ sensor, pediatric, 9-2
 M1192T Reusable SpO₂ sensor, pediatric, 9-3
 M1193A Reusable SpO₂ sensor, neonatal, 9-2
 M1193T Reusable SpO₂ sensor, neonatal, 9-3
 M1194A Reusable SpO₂ sensor, ear clip, 9-2
 M1195A Reusable SpO₂ sensor, infant, 9-2
 M1196A Reusable finger clip sensor, 9-3
 M1196A Reusable finger clip SpO₂ sensor, 9-2
 M1333A IUP catheter, 4-11
 M1334A IUP connector cable, 4-11
 M1347A DECG adapter, 4-6
 M1349A Fetal adhesive pad electrode, 4-4
 M1362B DECG legplate adapter cable, 4-4
 M1363A MECCG adapter cable, 4-15
 M1364-60001 ECG Patient module, 4-6
 M1420A 3-lead set, telemetry, 3-32
 M1421A 3-lead set, telemetry, 3-32
 M1422A 4-lead set, telemetry, 3-32
 M1423A 4-lead set, telemetry, 3-32
 M1424A 5-lead set, telemetry, 3-32
 M1425A 5-lead set, telemetry, 3-32
 M1430A 3-lead set, telemetry, 3-33
 M1431A 3-lead set, telemetry, 3-33
 M1432A 4-lead set, telemetry, 3-33
 M1433A 4-lead set, telemetry, 3-33
 M1434A 5-lead set, telemetry, 3-33
 M1435A 5-lead set, telemetry, 3-33
 M1460A CO₂ sensor, 8-3
 M1465A Reusable standard airway adapter, 8-3
 M1500A 3-Lead trunk cable, 3-2
 M1503A 3-Lead set organizer, 3-23
 M1504A 5-electrode set organizer, 3-23
 M1509A Bedsheet clip, 3-23
 M1510A 3-Lead trunk cable, 3-3
 M1520A 5-Lead trunk cable, 3-2
 M1530A 5-Lead trunk cable, 3-3
 M1531B MECCG leads, 4-15
 M1532A 4-lead set, AAMI, 3-13

- M1533A 4-lead set, IEC, 3-14
 M1537A 4-lead set, AAMI, 3-13
 M1538A 4-lead set, IEC, 3-14
 M1540C 3-Lead trunk cable, 3-2
 M1550C 3-lead trunk cable, 3-3
 M1557A 4-lead set, AAMI, 3-13
 M1558A 4-lead set, IEC, 3-14
 M1560C 5-Lead trunk cable, 3-2
 M1562A Fetal monitoring belt, 4-8
 M1562B Fetal monitoring belt, 4-8
 M1567A Invasive BP kit, 5-3
 M1568A Invasive BP kit, 5-3
 M1569A Fetal monitoring belt buttons, 4-10
 M1570C 5-Lead trunk cable, 3-3
 M1571A NIBP cuff, infant, 6-2
 M1572A NIBP cuff, pedi, 6-2
 M1573A NIBP cuff, sm. adult, 6-2
 M1574A NIBP cuff, adult, 6-2
 M1575A NIBP cuff, lg adult, 6-2
 M1576A NIBP cuff, thigh, 6-2
 M1577A NIBP cuff kit, 6-3
 M1578A NIBP cuff kit, 6-3
 M1579A NIBP cuff kit, 6-3
 M1580A 3-Lead trunk cable, 3-2
 M1590A 3-Lead trunk cable, 3-3
 M1596A NIBP tubing, 6-22
 M1597A NIBP tubing, 6-22
 M1598B NIBP tubing, 6-17
 M1599B NIBP tubing, 6-17
 M1600A 5-Lead trunk cable, 3-2
 M16013A 3-Lead set, 3-3
 M1602A 5-lead set, AAMI, 3-10
 M1603A 3-Lead set, 3-3
 M1604A 5-lead set, IEC, 3-12
 M1605A 3-Lead set, 3-3
 M1608A 3-Lead mini-clip, 3-3
 M1609A 3-Lead mini-clip, 3-3
 M1610A 5-Lead trunk cable, 3-3
 M1611A 3-Lead Set, 3-3
 M1612A Straight airway adapter, 8-6, 8-10
 M1613A 3-Lead set, 3-3
 M1614A Cable ties, 8-3
 M1615A 3-Lead set, 3-3
 M1619A 3-Lead mini-clip, 3-3
 M1620A 3-Lead trunk cable, 3-2
 M1621A 5-Lead set, 3-3
 M1622A 3-lead set, AAMI, 3-20
 M1623A 5-Lead set, 3-3
 M1624A 3-lead set, AAMI, 3-20
 M1625A 5-Lead set, 3-3
 M1626A 3-lead set, IEC, 3-22
 M1627A Velcro straps, 9-4
 M1629A 5-Lead mini-clip, 3-3
 M1630A 3-Lead trunk cable, 3-3
 M1631A 5-Lead set, 3-3
 M1633A 5-Lead set, 3-3
 M1634A Invasive BP cable, 5-3
 M1635A 5-Lead set, 3-3
 M1636A 3-electrode organizer, 3-23
 M1638A 5-electrode set organizer, 3-23
 M1638A 5-lead set organizer, 3-23
 M1639A 5-lead mini-clip, 3-3
 M1640A 3-Lead trunk cable, 3-2
 M1642A Cardiac output cable, 13-2
 M1643A Cardiac output cable, 13-2
 M1644A 4-electrode set organizer, 3-23
 M1644A 5-lead set, AAMI, 3-10, 3-17
 M1645A 5-lead set, 3-19
 M1645A 5-lead set, IEC, 3-12, 3-19
 M1646A PICCO temp probe, 13-2
 M1647A 5-lead set, AAMI, 3-17
 M1648A 5-lead set, IEC, 3-19
 M1649A Radiolucent lead set, 3-25
 M1655A Gas exhaust return line, 8-11
 M1655B Gas exhaust return line, 8-11
 M1658A Gas sample tubing, 8-11
 M1659A Calibration bag, 8-11
 M1660A Calibration gas cylinder, 8-11
 M1662A CAL gas, 8-11
 M1663A 10-lead ECG trunk cable (5+5), 3-10
 M1665A 10-lead ECG trunk cable (6+4), 3-13
 M1667A 6-lead trunk cable, 3-15
 M1668A 5-lead trunk cable, 3-17
 M1669A 3-lead trunk cable, 3-20
 M1671A 3-lead set, AAMI, 3-20
 M1672A 3-lead set, IEC, 3-22
 M1673A 3-lead set, AAMI, 3-20
 M1674A 3-lead set, IEC, 3-22
 M1675A 3-lead set, AAMI, 3-20
 M1678A 3-lead set, IEC, 3-22
 M1679A 6-electrode set organizer, 3-23
 M1680A 6-lead set, AAMI, 3-13, 3-15
 M1681A 6-lead set, IEC, 3-14, 3-16
 M1682A 6-lead set, AAMI, 3-13, 3-15
 M1683A 6-lead set, IEC, 3-14, 3-16
 M1684A 6-lead set, AAMI, 3-13, 3-15
 M1685A 6-lead set, IEC, 3-14, 3-16
 M1707A Thermal paper, 2-10
 M1708A Thermal paper, 2-10
 M1709A Thermal paper, 2-10
 M1710A Thermal paper, 2-10
 M1711A PageWriter XL replacement leads, 3-42
 M1712B PageWriter XL replacement leads, 3-42
 M1713B PageWriter XL lead set, 3-38
 M1714A PageWriter XL replacement leads, 3-42
 M1715A PageWriter XL replacement leads, 3-42
 M1716B PageWriter XL lead set, 3-38
 M1717B PageWriter XL replacement leads, 3-42
 M1718A Shorting plug set, 3-44
 M1719A PageWriter XL data cable, 3-38
 M1720A PageWriter XL data cable, 3-38
 M1721A PageWriter XL battery, 11-2
 M1733A 3-lead defib set, 3-35
 M1734A 5-lead defib set, 3-35
 M1735A 3-lead defib set, 3-35
 M1736A 5-lead defib set, 3-35
 M1737A TraceMaster View laser paper, 2-10
 M1738A TraceMaster View laser paper, 2-10
 M1741A Switchless Internal paddle with one-piece handle and electrode, 12-6
 M1742A Switchless Internal paddle with one-piece handle and electrode, 12-6
 M1743A Switchless Internal paddle with one-piece handle and electrode, 12-6
 M1744A Switchless Internal paddle with one-piece handle and electrode, 12-6
 M1781A CodeMaster test load, 12-4
 M1783A Sync cable, 12-7
 M1789A Replacement paddle electrode, 12-5
 M1837A Disposable temp probe, 7-2
 M1866A Neonatal NIBP #1, 6-21
 M1868A Neonatal NIBP #2, 6-21
 M1870A Neonatal NIBP #3, 6-21
 M1872A Neonatal NIBP #4, 6-21
 M1874A Disposable cuff, infant, 6-13
 M1875A Disposable cuff, pedi, 6-13
 M1876A Disposable cuff, sm adult, 6-13
 M1877A Disposable cuff, adult, 6-13
 M1878A Disposable cuff, lg adult, 6-13
 M1879A Disposable cuff, thigh, 6-13
 M1885A Thermal array Z-fold paper, 2-6
 M1901B OxiMax sensor, neonatal, 9-10
 M1902B OxiMax sensor, infant, 9-10
 M1903B OxiMax sensor, pediatric, 9-10
 M1904B OxiMax sensor, adult, 9-10
 M1910A Fetal paper, 2-7
 M1911A Fetal paper, 2-7
 M1913A Fetal paper, 2-7

- M1918A TcPO₂ transducer, 8-2
 M1920A FilterLine set, adult/pediatric, 8-7
 M1921A FilterLine H set, adult/pediatric, 8-7
 M1923A FilterLine H set, infant/neonatal, 8-7
 M1931A 5-lead EEG cable, 3-45
 M1931A EEG electrode, 1-11
 M1932A 5-lead EEG cable, 3-45
 M1932A EEG electrode, 1-11
 M1934A Miniclip 5-lead set, 3-45
 M1935A EEG electrode, 1-11
 M1937A EEG electrode, 1-11
 M1940A Reusable SpO₂ adapter cable, 9-4
 M1941B Reusable SpO₂ adapter cable, 9-4
 M1943A Reusable SpO₂ adapter cable, 9-4
 M1943AL Reusable SpO₂ adapter cable, 9-4
 M1943NL Reusable SpO₂ adapter cable, 9-4
 M1949A 10-lead ECG trunk cable (5+5), 3-10
 M1950A MIDA 10-lead trunk cable, 3-46
 M1951A MIDA 8-lead trunk cable, 3-46
 M1952A MIDA lead set, 3-46
 M1953A MIDA lead set, 3-46
 M1955A MIDA adapter cable, 3-46
 M1968A 5-lead set, AAMI, 3-10, 3-17
 M1971A 5-lead set, IEC, 3-12, 3-19
 M1973A 5-lead set, AAMI, 3-10, 3-17
 M1974A 5-lead set, IEC, 3-12, 3-19
 M1976A 5-lead set, AAMI, 3-10
 M1978A 5-lead set, IEC, 3-12
 M1979A 5-lead set, AAMI, 3-10
 M1984A 5-lead set, IEC, 3-12
 M1997A BIS Sensor Quatro, 8-12
 M1998A BIS Sensor Pediatric, 8-12
 M2202A Radiolucent electrode, 1-3
 M2203A MiniTEE bite guard, 10-4
 M2205A Calibration tubes, 8-2
 M2206A PTP anti-fade paper, 2-10
 M2207A PTP anti-fade paper, 2-10
 M2208A Fetal monitoring belt, 4-7
 M2243A TEE tip protector, 10-4
 M2253A Tab electrode, 1-7
 M2254A Tab electrode adapter, 3-43
 M2255A Disposable temp probe, 7-5
 M2267A Calibration regulator, 8-7
 M2268A 5-lead EEG trunk cable, 3-45
 M2271A Transducer holder, 5-3
 M2272A IV pole mount, 5-3
 M2281A Patient cable hooks, 3-23
 M2460A PageWriter 100/200/200i/300i battery, 11-2
 M2463A Case for PageWriter 100, 200, 200i, 300i, 11-5
 M2481A Thermal paper, 2-11
 M2483A Thermal paper, 2-11
 M2485A PTP anti-fade paper, 2-11
 M2486A PTP anti-fade paper, 2-11
 M2501A Mainstream CO₂ sensor, 8-3
 M2505A Gas regulator, 8-3
 M2506A Verification gas, 8-3
 M2513A Reusable airway adapter, adult/pedi, 8-3
 M2516A Reusable airway adapter, inf, 8-3
 M2520A Smart CapnoLine O₂, pediatric, 8-7
 M2522A Smart CapnoLine Plus O₂, adult, 8-7
 M2524A Smart CapnoLine, pediatric, 8-7
 M2526A Smart CapnoLine Plus, adult, 8-7
 M2533A Disposable airway adapter, adult, 8-3
 M2536A Disposable airway adapter, infant, 8-3
 M2590A 3-lead set, telemetry, 3-32
 M2591A 3-lead set, telemetry, 3-32
 M2592A 5-lead set, telemetry, 3-32
 M2593A 5-lead set, telemetry, 3-32
 M2594A 3-lead set, telemetry, 3-33
 M2595A 3-lead set, telemetry, 3-33
 M2596A 3-lead set, telemetry, 3-33
 M2597A 5-lead set, telemetry, 3-33
 M2598A 3-lead combiner shield, 3-32
 M2599A 5-lead combiner shield, 3-32
 M2738A Avalon Patient module, 4-6
 M2741A Sidestream CO₂ sensor, 8-4
 M2744A CO₂ nasal cannula, adult, 8-4
 M2745A CO₂ nasal cannula, pediatric, 8-4
 M2746A CO₂ nasal cannula, infant, 8-4
 M2750A CO₂/O₂ nasal cannula, adult, 8-4
 M2751A CO₂/O₂ nasal cannula, pediatric, 8-4
 M2756A CO₂ oral-nasal cannula, adult, 8-4
 M2757A CO₂ oral-nasal cannula, pediatric, 8-4
 M2760A CO₂/O₂ oral-nasal cannula, adult, 8-4
 M2761A CO₂/O₂ oral-nasal cannula, pediatric, 8-4
 M2768A Airway adapter set, 8-4
 M2772A Airway adapter set H, 8-4
 M2773A Airway adapter set H, 8-4
 M2776A Straight sample line, 8-4
 M2777A Straight sample Line H, 8-4
 M2781A CO₂/Flow sensor, adult/pediatric, 8-9
 M2782A CO₂/Flow sensor, infant/neonatal, 8-9
 M2783A CO₂/Flow sensor, pediatric, 8-9
 M2785A Flow sensor, 8-9
 M2786A Flow sensor, 8-9
 M3501A Philips (AAMI) adult electrode pads, 12-2
 M3502A Philips (IEC) adult electrode pads, 12-2
 M3503A Philips (IEC) pediatric electrode pads, 12-2
 M3504A Philips (AAMI) pediatric electrode pads, 12-2
 M3506A HeartStart battery charger adapter, 12-8
 M3507A Multi-function defibrillator electrode cable, 12-3
 M3508A HeartStart defibrillator hands-free electrode cable, 12-3
 M3508A HeartStart hands-free pad cable, 12-3
 M3509A HeartStart carrying case, 12-8
 M3516A HeartStart battery, 12-8
 M3524A FR2 data card reader, 12-15
 M3525A 10-lead trunk cable, defib, 3-36
 M3526A 3-wire lead set, defib, 3-36
 M3527A 7-wire lead set, defib, 3-36
 M3528A 3-wire lead set, 3-36
 M3529A 7-wire lead set, 3-36
 M3537A HeartStart MRx bed rail hook, 12-9
 M3538A HeartStart MRx battery, 12-8
 M3541A HeartStart MRx carrying case, 12-9
 M3542A External anterior/anterior paddle set, 12-5
 M3543A External Anterior/Anterior Paddle Set, 12-5
 M3544A HeartStart data card tray, 12-9
 M3545A HeartStart MRx data card and tray, 12-9
 M3702A Diagnostic ECG 10-lead set, 3-37
 M3702C Diagnostic ECG 10-lead set, 3-37
 M3703A Diagnostic ECG 10-lead, 3-37
 M3703C Diagnostic ECG 10-lead, 3-37
 M3707A Thermal paper, 2-11
 M3708A Thermal paper, 2-11
 M3713A HeartStart Adult Plus electrode pads, 12-2
 M3716A HeartStart Adult Radiolucent electrode pads, 12-2
 M3717A HeartStart Pediatric Plus electrode pads, 12-2
 M3718A HeartStart Adult Radiotransparent/Reduced Skin Irritation electrode pads, 12-2
 M3719A HeartStart Pediatric Radiotransparent/Reduced Skin Irritation electrode pad, 12-2
 M3725A HeartStart test load, 12-4
 M3752A AED Trainer 2, 12-20
 M3753A Remote control for AED Trainer 2, 12-20
 M3754A Optional programming kit for AED Trainer 2, 12-20
 M3755A Training Pads for AED Little Anne, 12-20
 M3756A AED Little Anne Training System, 12-20
 M3834A HS Event Review Software, 12-16
 M3848A FR2+ rechargeable battery, 12-13
 M3849A Charger for the FR2 rechargeable battery, 12-13
 M3853A FR2 AED tray for data card M3854A, 12-15
 M3854A FR2 AED data card and tray, 12-15
 M3855A Charger for FR2 AED training and admin pack, 12-20
 M3857A Wall mount for FR2 AED, 12-17
 M3858A AED wall sign, 12-17
 M3859A Secure pull seal for wall mount, 12-17
 M3860-97800 Quick Reference Card, HS FR2+, English, 12-21
 M3863A FR2 lithium manganese dioxide battery, 12-13

- M3864A Training and Admin pack for HS FR2 AED, 12-21
 M3868A Carrying case for Heartstream FR2 AED, 12-18
 M3869A Carrying case for FR2 AED, 12-18
 M3870A Self-adhesive FR2 electrode pads, 12-12
 M3871A HeartStart FR2 Training pads, 12-20
 M3873A FR2+ ECG Assessment Module, 12-14
 M3874A FR2+ ECG Assessment Module, 12-14
 M3913A ECG trunk cable, 3-27
 M3914A 3-lead set, IEC, 3-27
 M3915A 3-lead set, AAMI, 3-27
 M3916A Temp probe, A3, 7-6
 M3917A Temp probe, A3, 7-6
 M3918A NIBP tubing, 6-17
 M3919A Tote bag for A3 or FM2, 11-5
 M3920A Accessory bag for M3919A, 11-5
 M3941A PageWriter 10/10i battery, 11-2
 M4503A Fetal monitoring record file, 4-15
 M4504-60000 Stethoscope eartips, soft, 11-6
 M4504-60010 Stethoscope eartips, firm, 11-6
 M4504-60030 Stethoscope non-chill ring, 11-6
 M4504-91000 Stethoscope user manual, 11-6
 M4530-60020 Stethoscope diaphragm, 11-6
 M4530-60030 Stethoscope non-chill ring, 11-6
 M4530-60040 Stethoscope battery cover, 11-6
 M4530-60050 Stethoscope battery, 11-6
 M4530-91000 Stethoscope user manual, 11-6
 M4552A NIBP cuff, infant, 6-4
 M4552B NIBP cuff, infant, 6-7
 M4552B5 NIBP cuff, infant, 6-8
 M4553A NIBP cuffs, pedi, 6-4
 M4553B NIBP cuffs, pedi, 6-7
 M4553B5 NIBP cuffs, pedi, 6-8
 M4554A NIBP cuff, sm adult, 6-4
 M4554B NIBP cuff, sm adult, 6-7
 M4554B5 NIBP cuff, sm adult, 6-6, 6-8
 M4555A NIBP cuff, adult, 6-4
 M4555B NIBP cuff, adult, 6-7
 M4555B5 NIBP cuff, adult, 6-8
 M4556A NIBP cuff, adult, 6-4
 M4556B NIBP cuff, adult, 6-7
 M4556B5 NIBP cuff, adult, 6-8
 M4557A NIBP cuff, lg adult, 6-4
 M4557B NIBP cuff, lg adult, 6-7
 M4557B5 NIBP cuff, lg adult, 6-8
 M4558A NIBP lg adult x-long, 6-4
 M4558B NIBP lg adult x-long, 6-7
 M4558B5 NIBP lg adult x-long, 6-8
 M4559A NIBP cuff, thigh, 6-4
 M4559B NIBP cuff, thigh, 6-7
 M4559B5 NIBP cuff, thigh, 6-8
 M4562A NIBP cuff, infant, 6-6
 M4562B NIBP 2-hose, inf., 6-10
 M4563A NIBP cuffs, pedi, 6-6
 M4563B NIBP 2-hose, pedi, 6-10
 M4564B NIBP 2-hose, sm adult, 6-10
 M4565A NIBP cuff, adult, 6-6
 M4565B NIBP 2-hose, adult, 6-10
 M4566A NIBP cuff, adult, 6-6
 M4566B NIBP 2-hose, adult x-long, 6-10
 M4567A NIBP cuff, lg adult, 6-6
 M4567B NIBP 2-hose, lg adult, 6-10
 M4568A NIBP lg adult x-long, 6-6
 M4568B NIBP 2-hose, lg ad. x-long, 6-10
 M4569A NIBP cuff, thigh, 6-6
 M4569B NIBP 2-hose, thigh, 6-10
 M4572B Disposable cuff, infant, 6-14
 M4573B Disposable cuff, pedi, 6-14
 M4574B Disposable cuff, sm adult, 6-14
 M4575B Disposable cuff, adult, 6-14
 M4576B Disposable cuff, adult x-long, 6-14
 M4576B Disposable cuff, lg adult, 6-14
 M4578B Disposable cuff, large adult x-long, 6-14
 M4579B Disposable cuff, thigh, 6-14
 M4582B Disposable 2-hose cuff, inf., 6-16
 M4583B Disposable 2-hose cuff, pedi, 6-16
 M4584B Disposable 2-hose cuff, sm adult, 6-16
 M4585B Disposable 2-hose cuff, adult, 6-16
 M4586B Disposable 2-hose cuff, adult x-long, 6-16
 M4587B Disposable 2-hose cuff, large adult, 6-16
 M4588B Disposable 2-hose cuff, large adult x-long, 6-16
 M4589B Disposable 2-hose cuff, thigh, 6-16
 M4601A Fetal monitoring belt, 4-9
 M4602A Fetal monitoring belt, 4-8
 M4603A Fetal monitoring belt, 4-9
 M4604A TEE tip protector, 10-4
 M4605A Battery for IntelliVue, 11-3
 M4606A Skin prep, 1-2
 M4607A Battery for IntelliVue X2, MP2, 11-3
 M4608A ICG sensor, 13-3
 M4612A Solid gel electrode, 1-2
 M4613A Solid gel electrode, 1-2
 M4615A BIS SRS Sensor, 8-12
 M4620A ICG cable, grabbers, 13-3
 M4620A Impedance Cardiography cable, 3-27
 M4680A CapnoLine H O₂, adult, 8-7
 M4681A CapnoLine H O₂, pediatric, 8-7
 M4686A NIV line, adult, 8-7
 M4687A NIV line, pediatric, 8-7
 M4689A CapnoLine H, adult, 8-7
 M4690A CapnoLine H, pediatric, 8-7
 M4691A CapnoLine H, infant/neonatal, 8-7
 M4740A HeartStart Switchless Internal paddle adapter, 12-7
 M4741A Switched Internal paddle electrodes, 12-6
 M4742A Switched Internal paddle electrodes, 12-6
 M4743A Switched Internal paddle electrodes, 12-6
 M4744A Switched Internal paddle electrodes, 12-6
 M4745A External anterior/anterior paddle set, 12-5
 M4746A External anterior/anterior paddle set, 12-5
 M4748A Adapter extension cable for Heartstream XL Defibrillator/
 Monitor, 12-7
 M4748A HeartStart extension cable, 12-3
 M4751A Accessory pouch for Heartstart XL, 12-8
 M4759A Paddle Electrode Replacement, 12-5
 M4761A Q-CPR Compression sensor, 12-10
 M4762A Q-CPR sensor adhesive pad, 12-10
 M4789A Nellcor Durasensor, 9-6
 M4790A Telemetry battery pack, 11-3
 M4793A 5-lead extender cable, telemetry, 3-34
 M4794A 5-lead extender cable, telemetry, 3-34
 M4795A 3-lead extender cable, telemetry, 3-34
 M4796A 3-lead extender cable, telemetry, 3-34
 M4816A Thermal array paper, 2-6
 M4817A Thermal array paper, 2-6
 M4821A Oral temp probe, 7-7
 M4822A Rectal temp probe, 7-7
 M4823A Temp probe covers, 7-7, 7-8
 M5066-89100 FR2+ & HS1 Instructors Training Toolkit, 12-21
 M5066-97800 Quick Reference for HS1, 12-21
 M5070A HS1/FRx battery, 12-13
 M5071A Adult SMART Pads Cartridge, 12-12
 M5072A Infant/Child SMART Pads Cartridge, 12-12
 M5073A HS1 Adult Training Pads Cartridge, 12-21
 M5074A HS1 Infant/Child Training Pads Cartridge, 12-21
 M5075A Slim carrying case for HS1, 12-18
 M5076A Slim carry case for HS1, 12-18
 M5085A HeartStart Trainer, 12-22
 M5088A Internal Manikin Adapter, 12-22
 M5089A External Manikin Adapter, 12-22
 M5093A HS1 Replacement Adult Training Pads, 12-21
 M5094A HS1 Replacement Infant/Child Training Pads, 12-21
 M5509A Carrying case, 12-8
 M5521A-M5525A HS MRx colored handles, 12-9
 M5526A Sync Cable, 12-7
 M5528A HeartStart MRx mounting bracket, 12-9
 M5529A HeartStart MRx DC Power Module, 12-9
 PFE7023D AED Cabinet, semi-recessed, with audible alarm and
 light, 12-18

PFE7024D AED Cabinet, wall surface mounted, with audible alarm and light, 12-18
 PSE11268 Seiko paper, 2-6
 SDCF05 Adapter, Data Card to PCMCIA, 12-15
 ULBU9VLJ Telemetry 9V battery, 11-3
 YC Carrying case, hard plastic waterproof shell, 12-18

A**AED Supplies****Accessories**

68-PCHAT AED Fast Response Kit, 12-14
 861276 HS Event Review Pro software, 12-16
 861311 A01 HS Review Express software, 12-16
 989803139311 Infant/Child key, 12-14
 989803141811 HS Event Review software, 12-16
 989803143041 HS Configure-PDA software, 12-16
 989803143051 HS Case Capture software, 12-16
 ACT-IR Infrared data cable, 12-15
 M3524A FR2 data card, 12-15
 M3834A HS Event Review software, 12-16
 M3853A FR2 AED tray for data card, 12-15
 M3854A FR2 AED data card and tray, 12-15
 M3873A FR2+ ECG assessment module, 12-14
 M3874A FR2+ ECG assessment module, 12-14
 SDCF05 Data card adapter, 12-15

Batteries

989803136291 FR2 aviation-battery, 12-13
 989803136301 ForeRunner aviation-battery, 12-13
 BT1 ForeRunner battery, 12-13
 M3848A FR2+ battery, 12-13
 M3849A FR2+ battery charger, 12-13
 M3863A FR2 battery, 12-13
 M5070A HS1/FRx battery, 12-13

Cases and Wall Mounts

989803133171 Temp control case, 12-18
 989803136531 Basic cabinet, 12-18
 989803139251 FRx case, 12-18
 M3857A Wall bracket, 12-17
 M3858A AED wall sign, 12-17
 M3859A Wall mount, 12-17
 M3868A FR2 case, 12-18
 M3869A FR2 case, 12-18
 M5075A HS1 case, 12-18
 M5076A HS1 slim case, 12-18
 PFE7023D AED cabinet, 12-18
 PFE7024D AED cabinet, 12-18
 YC carrying case, 12-18

Pads and Accessories

989803139261 SMART Pads II, 12-12
 DP2 adult electrode pad, 12-12
 DP6 adult electrode pad, 12-12
 M3870A infant/child electrode pad, 12-12
 M5071A adult SMART pads, 12-12
 M5072A Infant/child SMART pads, 12-12

Training Materials

07-10900 Adult training electrode pads, 12-20
 07-11000 AED Trainer 2 case, 12-20
 861306 HeartStart FR2 trainer, 12-22
 989803139271 Training Pads II, 12-21
 989803150291 FR2+ instructor's toolkit, 12-21
 M3752A AED Trainer 2, 12-20
 M3753A Remote control for Trainer 2, 12-20
 M3754A Trainer 2 programming kit, 12-20
 M3755A Little Anne training pads, 12-20
 M3756A Little Anne Training System, 12-20
 M3855A Charger, 12-20
 M3860-97800 HS FR2+ quick reference card, 12-21
 M3864A Training and admin pack, FR2, 12-21
 M3871A HS FR2 infant/child training pads, 12-20
 M5066-89100 HS1 Instructor training toolkit, 12-21
 M5066-97800 HS1 quick reference, 12-21
 M5073A HS1 adult training pads cartridge, 12-21

M5074A HS1 infant/child training pads cartridge, 12-21
 M5085A HeartStart Trainer, 12-22
 M5088A Internal Manikin adapter, 12-22
 M5089A External Manikin adapter, 12-22
 M5093A HS1 Replacement training pads, 12-21
 M5094A HS1 replacement training pads, 12-21

B**Batteries**

40455A Telemetry battery, 11-3
 40488A Rechargeable 12V lead acid battery, 11-2
 989803129131 PageWriter Touch battery, 11-2
 989803130151 PageWriter Trim battery, 11-2
 989803144631 SureSigns battery, 11-3
 M1721A PageWriter XL battery, 11-2
 M2460A PageWriter 100/200/200i battery, 11-2
 M3941A PageWriter 10/10i battery, 11-2
 M4605A MP20/30, MP40/50 battery, 11-3
 M4607A MP2, X2 battery, 11-3
 M4790A Rechargeable Telemetry battery, 11-3
 UBLU9VL 9-V Telemetry battery, 11-3

C**Cables and Leads****EEG Cables and Leads**

M1931A Reusable 5-Lead cup electrode, 3-45
 M1932A Reusable 5-Lead cup electrode, 3-45
 M1934A EEG 5-Lead miniclip, grabbers, 3-45
 M2268A EEG 5-Lead trunk cable, 3-45
 M4620A ICG cable, 3-27

Cardiac Output

14455A Ice bucket, 13-2
 15244A Remote start switch, 13-2
 23001A Temperature probe, injectate, 13-2
 23001B Temperature probe, injectate, 13-2
 23002A Temperature probe, ice bath, 13-2
 M1642A Cardiac output cable, 13-2
 M1643A Cardiac output cable, 13-2
 M1646A Cardiac PICCO temperature probe, 13-2
 M4608A ICG Disposable sensor, 13-3
 M4620A ICG one-piece cable, 13-3

Cases and Pouches

989803136651 Digitrak Plus pouch, 11-5
 989803137961 StressVue pouch, 11-5
 989803137971 StressVue pouch, 11-5
 989803144351 StressVue pouch, 11-5
 M2463A PageWriter case, 11-5
 M3919A Canvas tote bag, 11-5
 M3920A Snap-on accessory bag, 11-5

D**Defibrillator Supplies****Batteries, Cases, Accessories**

861276 HS Event Review Pro software, 12-11
 989803142521 HS 12-Lead Transfer Station, 12-11
 989803147711 HS data card, 12-11
 989803147721 HS data card, 12-11
 BT1 ForeRunner lithium manganese dioxide battery, 12-13
 M3506A Battery charger adapter, 12-8
 M3509A HeartStart case, 12-8
 M3516A Battery, 12-8
 M3537A Bed rail hook, 12-9
 M3538A HeartStart MRx battery, 12-8
 M3541A Carrying case, 12-9
 M3544A Data card tray, 12-9
 M3545A Data card and tray, 12-9
 M4751A Accessory pouch, 12-8
 M4761A Q-CPR Sensor, 12-10
 M4762A Q-CPR sensor adhesive pad, 12-10
 M4763A Pads/CPR cable, 12-10
 M5509A HeartStart 4000 case, 12-8
 M5521A Green handle, 12-9
 M5522A Blue handle, 12-9
 M5523A Yellow handle, 12-9

M5524A Rose handle, 12-9
 M5525A Grey handle, 12-9
 M5528A Vehicle wall mount, 12-9
 M5529A DC Power Module, 12-9

External Pads and Cables

M3501A Adult pads, 12-2
 M3502A Adult pads, 12-2
 M3503A Pediatric pads, 12-2
 M3504A Pediatric pads, 12-2
 M3507A Hands-free pad cable, 12-3
 M3508A HeartStart Hands-free pad cable, 12-3
 M3713A HeartStart Adult Plus pads, 12-2
 M3716A HeartStart Adult Radiolucent pads, 12-2
 M3717A HeartStart Pediatric Plus pads, 12-2
 M3718A HeartStart Adult Radiotransparent pads, 12-2
 M3719A HeartStart Pediatric Radiotransparent pads, 12-2
 M4748A HeartStart extension cable, 12-3

Pad Adapters and Cables

05-10000 HS pad adapter, 12-4
 05-10100 HS pad adapter, 12-4
 05-10200 HS pad adapter, 12-4
 M1781A Adapter cable test load, 12-4
 M3725A Adapter cable test load, 12-4

Paddle Sets

M1741A Internal paddle set, 12-6
 M1742A Internal paddle set, 12-6
 M1743A Internal paddle set, 12-6
 M1744A Internal paddle set, 12-6
 M1789A Replacement electrodes, 12-5
 M3542A External paddle set, 12-5
 M3543A External paddle set, 12-5
 M4740A Internal paddle adapter, 12-7
 M4741A Internal paddle set, 12-6
 M4742A Internal paddle set, 12-6
 M4743A Internal paddle set, 12-6
 M4744A Internal paddle set, 12-6
 M4745A External paddle set, 12-5
 M4746A External paddle set, 12-5
 M4748A Internal paddle adapter, 12-7
 M4759A Replacement electrodes, 12-5

E**ECG Cables and Leads****A1/A3/C1**

M3913A 3-Lead trunk cable, 3-27
 M3914A 3-Leadset, IEC, 3-27
 M3915A 3-Leadset, AAMI, 3-27

Accessories

989803148841 cable management kit, 3-23
 989803148861 trunk cable covers, 3-23
 M1503A 3-electrode set organizer, 3-23
 M1504A 5-electrode set organizer, 3-23
 M1509A bedsheet clip, 3-23
 M1636A 3-electrode set organizer, 3-23
 M1638A 5-electrode set organizer, 3-23
 M1644A 4-electrode set organizer, 3-23
 M1679A 6-electrode set organizer, 3-23
 M2281A cable organizer (hooks), 3-23

Defib Cables

989803147691 10-Electrode trunk cable, 3-36
 M1733A Trunk cable/leadset, 3-35
 M1734A Trunk cable/leadset, 3-35
 M1735A Trunk cable/leadset, 3-35
 M1736A Trunk cable/leadset, 3-35
 M3525A 10-electrode trunk cable, 3-36
 M3526A 3-electrode lead set, 3-36
 M3527A 7-electrode lead set, 3-36
 M3528A 3-electrode lead set, 3-36
 M3529A 7-electrode lead set, 3-36

Diagnostic ECG

40431B alligator clip adapter, 3-43
 40432B alligator clip adapter, 3-43
 40475A lead adapter, 3-44

40498E lead adapter, 3-44
 9898031 29141 PW Touch/Trim replacement leads, 3-40
 9898031 29151 PW Touch/Trim replacement leads, 3-40
 9898031 29161 PW Touch/Trim replacement leads, 3-40
 9898031 48931 PW Touch upgrade kit, 3-40
 989803129171 PW Touch/Trim replacement leads, 3-40
 989803129181 PW Touch/Trim replacement leads, 3-40
 989803129191 PW Touch/Trim replacement leads, 3-40
 989803129201 PW Touch/Trim replacement leads - long, 3-41
 989803129211 PW Touch/Trim leads - long, 3-41
 989803129221 PW Touch/Trim leads - long, 3-41
 989803129231 alligator clip adapter, 3-43
 989803129241 alligator clip adapter, 3-43
 989803136951 StressVue 10-lead set, 3-39
 989803136961 StressVue 10-lead-set, 3-39
 989803137661 StressVue 10-lead set, 3-39
 989803137671 StressVue 10-lead set, 3-39
 989803145401 data cable, PW Touch, 3-38
 989803148881 Spare parts kit for 16-lead, PageWriter Touch, 3-43
 989803149181 PW Touch replacement leads, 3-40
 989803149191 PW Touch/Trim leads - long, 3-41
 M1711A PW XL Lead set, limbs, 3-42
 M1712B PW XL leadset, chest, 3-42
 M1713B Complete lead set, PageWriter XL, 3-38
 M1714A PW XL lead set, limbs, 3-42
 M1715B PW XL leadset, chest, 3-42
 M1716B Complete lead set, PageWriter XL, 3-38
 M1717B leadset, pediatric and Frank, 3-42
 M1718A shorting plug, 3-44
 M1719A data cable, PageWriter XL, 3-38
 M1720A data cable, PageWriter XL, 3-38
 M2254A electrode adapter, 3-43
 M3702A 10-Lead patient cable, 3-37
 M3702C 10-Lead patient cable, 3-37
 M3703A 10-Lead patient cable, 3-37
 M3703C 10-Lead patient cable, 3-37

ECG Monitoring Lead Sets

M1532A 4-lead ICU set, 3-13
 M1533A 4-lead ICU set, 3-14
 M1537A 4-lead ICU set, 3-13
 M1538A 4-lead ICU set, 3-14
 M1557A 4-lead OR set, 3-13
 M1558A 4-lead OR set, 3-14
 M1602A 5-lead ICU set, 3-10
 M1604A 5-lead ICU set, 3-12
 M1622A 3-Lead Mini-clip, AAMI, 3-20
 M1624A 3-lead set, AAMI, 3-20
 M1626A 3-lead Mini-clip, IEC, 3-22
 M1644A 5-lead ICU set, AAMI, 3-10, 3-17
 M1645A 5-lead ICU set, IEC, 3-12, 3-19
 M1647A 5-lead Mini-clip, AAMI, 3-17
 M1648A 5-lead ICU set, IEC, 3-19
 M1649A 5-Lead radiolucent set, grabber, 3-25
 M1671A 3-Lead ICU set, AAMI, 3-20
 M1672A 3-lead ICU set, IEC, 3-22
 M1673A 3-Lead ICU set, AAMI, 3-20
 M1674A 3-lead ICU set, IEC, 3-22
 M1675A 3-Lead OR set, AAMI, 3-20
 M1678A 3-lead OR set, IEC, 3-22
 M1680A 6-lead ICU set, 3-13
 M1680A 6-lead ICU set, AAMI, 3-15
 M1681A 6-lead ICU set, IEC, 3-14, 3-16
 M1682A 6-lead ICU set, AAMI, 3-13, 3-15
 M1683A 6-lead ICU set, IEC, 3-14, 3-16
 M1684A 6-lead ICU set, AAMI, 3-15
 M1684A 6-lead OR set, AAMI, 3-13
 M1685A 6-lead OR set, IEC, 3-14, 3-16
 M1968A 5-lead ICU set, AAMI, 3-10, 3-17
 M1971A 5-lead ICU set, IEC, 3-12, 3-19
 M1973A 5-lead OR set, AAMI, 3-10, 3-17
 M1974A 5-lead ICU set, IEC, 3-12, 3-19
 M1976A 5-lead ICU set, AAMI, 3-10
 M1978A 5-lead ICU set, IEC, 3-12

- M1979A 5-lead OR set, AAMI, 3-10
M1984A 5-lead ICU set, IEC, 3-12
- MIDA**
M1950A 10-lead trunk cable, 3-46
M1951A 8-lead trunk cable, 3-46
M1952A 5-lead set, 3-46
M1953A 3/5-lead set, 3-46
M1955A Adapter cable, 3-46
- SureSigns**
9898093143171 3-lead cable, IEC, 3-26
9898093143181 3-lead cable, AAMI, 3-26
9898093143191 5-lead cable, IEC, 3-26
9898093143201 5-lead cable, AAMI, 3-26
- Telemetry**
989803140401 Telemetry alignment guide, 3-31
989803140411 Telemetry alignment guide, 3-31
989803140421 Double alignment guide, 3-31
989803143481 PWD tether cable, 3-30
989803143491 Telemon tether cable, 3-30
989803146911 MP5 tether cable, 3-30
989803151971 3-Lead IntelliVue telemetry set, 3-28
989803151981 3-Lead IntelliVue telemetry set, 3-29
989803151991 3-Lead IntelliVue telemetry set, 3-28
989803152001 3-Lead IntelliVue telemetry set, 3-29
989803152051 5-Lead IntelliVue telemetry set, 3-28
989803152061 5-Lead IntelliVue telemetry set, 3-29
989803152071 5-Lead IntelliVue set, 3-28
989803152081 5-Lead IntelliVue telemetry set, 3-29
989803152131 6-Lead IntelliVue telemetry set, 3-28
989803152141 6-Lead IntelliVue telemetry set, 3-29
989803152151 6-Lead IntelliVue telemetry set, 3-28
989803152161 6-Lead IntelliVue telemetry set, 3-29
989803153031 3-Lead Shower Shields, 3-31
989803153041 5-Lead Shower Shield, 3-31
989803153051 6-Lead Shower Shield, 3-31
M1420A 3-Lead, AAMI, 3-32
M1421A 3-Lead, AAMI, 3-32
M1422A 4-Lead, AAMI, 3-32
M1423A 4-Lead, AAMI, 3-32
M1424A 5-Lead, AAMI, 3-32
M1425A 5-Lead, AAMI, 3-32
M1430A 3-Lead, IEC, 3-33
M1431A 3-Lead, IEC, 3-33
M1432A 4-Lead, IEC, 3-33
M1433A 4-Lead, IEC, 3-33
M1434A 5-Lead, IEC, 3-33
M1435A 5-Lead, IEC, 3-33
M2590A 3-Lead, AAMI, 3-32
M2591A 3-Lead, AAMI, 3-32
M2592A 5-Lead, AAMI, 3-32
M2593A 5-Lead, AAMI, 3-32
M2594A 3-Lead, IEC, 3-33
M2595A 3-Lead, IEC, 3-33
M2596A 5-Lead, IEC, 3-33
M2597A 5-Lead, IEC, 3-33
M2598A 3-Lead combiner, 3-32
M2599A 5-Lead combiner, 3-32
M4793A ECG extender cables, 3-34
M4794A ECG extender cable, 3-34
M4795A ECG extender cable, 3-34
M4796A ECG extender cable, 3-34
- Trunk Cables**
M1663A 10-lead ECG trunk cable (5+5), 3-10
M1665A 10-lead ECG trunk cable (6+4), 3-13
M1667A 6-lead ECG trunk cable, 3-15
M1668A 5-lead ECG trunk cable, 3-17
M1669A 3-lead ECG trunk cable, 3-20
M1949A 10-lead ECG trunk cable (5+5), 3-10
- Electrodes**
Adult Monitoring
13941E Disposable electrode, 1-3
13942E Disposable electrode, 1-3
40489E Disposable electrode, 1-3
40493D Disposable electrode, 1-2
40493E Disposable electrode, 1-2
9898031 48801 Disposable electrode, 1-2
9898031 48811 Disposable electrode, 1-2
9898031 48821 Disposable electrode, 1-2
M2202A Disposable electrode, 1-3
M4612A Disposable electrode, 1-2
M4613A Disposable electrode, 1-2
- Diagnostic Cardiology**
13943B Disposable electrode, 1-7
13944B Disposable electrode, 1-7
14030A Reusable electrode strap, 1-10
40418A Reusable electrode, 1-8
40419A Welsh bulb replacement, 1-8
40420A Disposable electrode, 1-7
40421A Reusable electrode, 1-8
40422A Welsh bulb replacement, 1-8
40424A Reusable limb plate electrode, 1-9
40490E Reusable electrode, 1-8
40491E Reusable limb plate electrode, 1-9
40494E Reusable limb plate electrode, 1-9
9898031 49901 Pediatric tab electrode, 1-7
M2253A Disposable electrode, 1-7
- EEG Electrodes**
M1931A Reusable electrode, 1-11
M1932A Reusable electrode, 1-11
M1935A Disposable electrode, 1-11
M1937A Reusable electrode, 1-11
- Neonatal/Pediatric**
13950B Disposable electrode, 1-6
13951C Disposable electrode, 1-6
13952A Disposable electrode, 1-4
13952B Disposable electrode, 1-5
13952D Disposable electrode, 1-4
13952E Disposable electrode, 1-5
13953A Disposable electrode, 1-4
13953B Disposable electrode, 1-5
13953D Disposable electrode, 1-4
13953E Disposable electrode, 1-5
13955C Disposable electrode, 1-6
- Skin Prep**
M4606A Skin Prep Paper, 1-2
- F**
Fetal Monitoring
Belts, Disposable
14328A Disposable abdominal belt, 4-7
M2208A Disposable abdominal belt, 4-7
- Belts, Reusable**
1500-0628 Leg belt, bulk roll, 4-9
1500-0642 Pre-cut abdominal belt, 4-8
1500-0643 Abdominal belt, bulk roll, 4-9
15155-43101 belt guide, 4-10
989803143401 Plastic belt clip, 4-10
M1562A Abdominal belt, 4-8
M1562B Abdominal belt, 4-8
M1569A Belt buttons, 4-10
M4601A Leg belt, bulk roll, 4-9
M4602A Pre-cut abdominal belt, 4-8
M4603A Abdominal belt, bulk roll, 4-9
- DECG**
15133D Qwik Connect double spiral electrode, 4-4
15133E Qwik Connect single spiral electrode, 4-4
989803137631 Fetal spiral electrode, 4-2
989803137641 Fetal double spiral electrode, 4-2
989803137651 DECG legplate adapter cable, 4-3
989803137791 DECG legplate adapter cable, 4-3
989803137801 DECG legplate adapter cable, 4-3
989803137811 DECG legplate adapter cable, 4-3
989803139771 Fetal attachment electrode, 4-3
M1347A DECG adapter, 4-6
M1349A Disposable fetal electrode, 4-4
M1362B DECG legplate adapter, Quik Connect, 4-4

M1364-60001 ECG Patient module, 4-6
M2738A Fetal/Maternal ECG Patient Module, 4-6

Intrauterine Pressure

989803143931 Connector Cable for IUP, 4-11
CPJ84022 Sterile domes, 4-12
CPJ84046 Pressure transducer holder, 4-12
CPJ840J5 Reusable IUP pressure transducer, 4-12
CPJ84447 IV pole mount, 4-12
M1333A Sensor-tip, IUP catheter, 4-11
M1334A Connector Cable for IUP, 4-11

Miscellaneous Fetal Monitoring Supplies

40483A Ultrasound gel, 4-15
40483B Ultrasound gel refill, 4-15
862214 Standard Antepartum kit (N.Am), 4-16
862215 Standard Antepartum kit (EUR), 4-16
862216 Standard Antepartum kit (JAP), 4-16
862217 Intrapartum kit DECG kit, 4-16
989803143411 Event Marker, 4-15
M1363A MECG adapter cable, 4-15
M1531B Leads, MECG, 4-15
M3919A Canvas tote bag, 4-15
M4503A Fetal Monitoring Record File, 4-15
Recording Paper, 4-13

G**Gas Monitoring****Anesthetic Gas**

13901A Nafion sample tube, 8-10
13902A Airway adapter, elbow, 8-10
13904A Bacteria filter, 8-10
13905A Nafion/poly sample tube, 8-10
13906A Calibration gas cylinder, 8-10
13907A Calibration tube assembly, 8-10
M1612A Straight airway adapter, 8-10
M1655A Reusable gas exhaust return line, 8-11
M1655B Reusable gas exhaust return line, 8-11
M1656B Disposable gas exhaust return filter, 8-11
M1657B Water Trap, 8-11
M1657B Water trap, 8-11
M1658A Gas sample tubing, 8-11
M1659A Calibration bag, 8-11
M1660A Calibration gas cylinder, 8-11
M1662A CAL gas, 8-11

Bispectral Index

989803143581 BIS sensor pediatric, 8-12
989803143961 BIS SRS Dispenser Holder, 8-12
M1997A Aspect BIS Sensor Quatro, 8-12
M1998A Aspect BIS Sensor Pediatric, 8-12
M4615A BIS SRS sensor, 8-12

Mainstream CO₂ Monitoring

14363A Airway adapter, pediatric reusable, 8-3
M1460A CO₂ sensor, 8-3
M1465A Airway adapter, reusable, 8-3
M1614A Cable ties, 8-3
M2501A IntelliVue Mainstream CO₂ Sensor, 8-3
M2505A Gas regulator, 8-3
M2506A Verification gas, 8-3
M2513A Reusable airway, 8-3
M2516A Reusable airway adapter, 8-3
M2533A Disposable airway adapter, 8-3
M2536A Disposable airway adapter, 8-3
M2744A Sidestream CO₂ cannula, 8-4
M2745A Sidestream CO₂ cannula, 8-4
M2746A Sidestream CO₂ cannula, 8-4
M2750A Sidestream CO₂ cannula, 8-4
M2751A Sidestream CO₂ cannula, 8-4
M2756A Sidestream CO₂ cannula, 8-4
M2757A Sidestream CO₂ cannula, 8-4
M2760A Sidestream CO₂ cannula, 8-4
M2761A Sidestream CO₂ cannula, 8-4
M2768A Sidestream CO₂ cannula, 8-4
M2772A Sidestream CO₂ cannula, 8-4
M2773A Sidestream CO₂ cannula, 8-4
M2776A Sidestream CO₂ cannula, 8-4

M2777A Sidestream CO₂ cannula, 8-4

Microstream CO₂ Monitoring

M1920A Adult/Pediatric FilterLine set, 8-7
M1921A Adult/Pediatric FilterLine H set, 8-7
M1923A Infant/Neonatal FilterLine H set, 8-7
M2267A Calibration regulator, 8-7
M2520A Pediatric Smart CapnoLine O₂, 8-7
M2522A Adult Smart CapnoLine Plus O₂, 8-7
M2524A Pediatric Smart CapnoLine, 8-7
M2526A Adult Smart CapnoLine Plus, 8-7
M4680A Adult CapnoLine H O₂, 8-7
M4681A Pediatric CapnoLine H O₂, 8-7
M4686A Adult NIV Line, 8-7
M4687A Pediatric NIV Line, 8-7
M4689A Adult CapnoLine H, 8-7
M4690A Pediatric CapnoLine H, 8-7
M4691A Infant/neonatal CapnoLine H, 8-7

Sidestream CO₂ Monitoring

13901A Nafion sample tube, 8-6
13902A Airway adapter, elbow, 8-6
13904A Bacteria filter, 8-6
13905A Nafion/poly sample tube, 8-6
M1612A Straight airway adapter, 8-6
M2741A IntelliVue Sidestream CO₂ Sensor, 8-4

Spirometry CO₂ Flow

M2781A Combined CO₂ Flow Sensor, 8-9
M2782A Combined CO₂ Flow Sensor, 8-9
M2783A Combined CO₂ Flow Sensor, 8-9
M2785A Flow Sensor, 8-9
M2786A Flow Sensor, 8-9

TcPO₂/CO₂ Monitoring

15209-60010 Accessory kit, 8-2
15209-60020 Fixation kit, 8-2
15210-60010 Calibration cylinders, 8-2
15210-60020 Calibration cylinders, transducer, 8-2
15210-64010 Calibration cylinders, transducer, 8-2
15210-64020 Calibration cylinders, transducer, 8-2
M1918A Transducer, 8-2
M2205A Calibration tubes, 8-2

I**Invasive Pressure**

CPJ84022 Sterile domes, 5-2
CPJ84026 Lines sets, 5-2
CPJ84046 Pressure transducer holder, 5-2
CPJ840J5 Reusable IUP pressure transducer, 5-2
CPJ840J6 Reusable blood pressure transducer, 5-2
CPJ84447 IV pole mount, 5-2
M1567A Blood pressure kit (Europe), 5-3
M1568A Dual line blood pressure kit (Europe), 5-3
M1634A Blood pressure adapter cable, 5-3
M2271A Pressure transducer holder (Europe), 5-3
M2272A IV Pole Mount, 5-3

M**Miscellaneous**

280-100-C25 Stethoscope Replace Part, 11-7
280-100-C26 Stethoscope Replacement Part, 11-7
280-100-C27 Stethoscope Replacement Part, 11-7
280-100-C30 Stethoscope Replacement Part, 11-7
280-100-C31 Stethoscope Replacement Part, 11-7
9300-0768-050 Telemetry pouch, 11-4
9300-0768-200 Telemetry pouch, 11-4
989803137831 Transceiver pouch, 11-4
989803140371 Transceiver pouch, 11-4
989803140431 TeleMon protective cover, 11-4
989803140441 Telemetry protective cover, 11-4
989803140451 TeleMon protective cover, 11-4
989803151051 Medical grade DVDs, 11-5
989803153441 Carrying strap for X2/MP2, 11-5
989803157171 Anti-slip pad for X2/MP2, 11-5
M4504-60000 Stethoscope Replacement Parts, 11-6
M4504-60010 Stethoscope Replacement Parts, 11-6

M4504-60020 Stethoscope Replacement Parts, 11-6
 M4504-60030 Stethoscope Replacement Parts, 11-6
 M4504-60040 Stethoscope Replacement Parts, 11-6
 M4504-60050 Stethoscope Replacement Parts, 11-6
 M4504-91000 Stethoscope Replacement Parts, 11-6

N**Non-Invasive Blood Pressure****Disposable**

M1866A Pressure cuff, neonatal size 1, 6-21
 M1868A Pressure cuff, neonatal size 2, 6-21
 M1870A Pressure cuff, neonatal size 3, 6-21
 M1872A Pressure cuff, neonatal size 4, 6-21
 M1874A Cuff, infant, 6-13
 M1875A Cuff, pediatric, 6-13
 M1876A Cuff, small adult, 6-13
 M1877A Cuff, adult, 6-13
 M1878A Cuff, large adult, 6-13
 M1879A Cuff, thigh size, 6-13
 M4572B Cuff, single hose, infant, 6-14
 M4573B Cuff, single hose, pediatric, 6-14
 M4574B Cuff, single hose, small adult, 6-14
 M4575B Cuff, single hose, adult, 6-14
 M4576B Cuff, single hose, adult extra long, 6-14
 M4577B Cuff, single hose, large adult, 6-14
 M4578B Cuff, single hose, large adult extra long, 6-14
 M4579B Cuff, single hose, thigh, 6-14
 M4582B Pressure cuff, double hose, infant, 6-16
 M4583B Pressure cuff, double hose, pediatric, 6-16
 M4584B Pressure cuff, double hose, small adult, 6-16
 M4585B Pressure cuff, double hose, adult, 6-16
 M4586B Pressure cuff, double hose, adult extra long, 6-16
 M4587B Pressure cuff, double hose, large adult, 6-16
 M4588B Pressure cuff, double hose, large adult extra long, 6-16
 M4589B Pressure cuff, double hose, thigh, 6-16

Reusable

40400A Pressure cuff kit, 3 cuffs, 6-12
 40400B Pressure cuff kit, 5 cuffs, 6-12
 40401A Cuff, infant, 6-11
 40401B cuff, pediatric, 6-11
 40401C cuff, adult, 6-11
 40401D cuff, large adult, 6-11
 40401E cuff, thigh, 6-11
 M1571A Cuff, infant, 6-2
 M1572A Cuff, pediatric, 6-2
 M1573A Cuff, small adult, 6-2
 M1574A Cuff, adult, 6-2
 M1575A Cuff, large adult, 6-2
 M1576A Cuff, thigh, 6-2
 M1577A Pressure cuff kit, pediatric, 6-3
 M1578A Pressure cuff kit, adult, 6-3
 M1579A Pressure cuff kit, pediatric/adult, 6-3
 M4552A Cuff, single hose, infant, 6-4
 M4552B Cuff, single hose, infant, 6-7
 M4552B5 Cuff, single hose, infant, 6-8
 M4553A Cuff, double hose, pediatric, 6-6
 M4553A Cuff, single hose, pediatric, 6-4
 M4553B Cuff, single hose, pediatric, 6-7
 M4553B5 Cuff, single hose, pediatric, 6-8
 M4554A Cuff, single hose, small adult, 6-4
 M4554B Cuff, single hose, small adult, 6-7
 M4554B5 Cuff, single hose, small adult, 6-8
 M4555A Cuff, single hose, adult, 6-4
 M4555B Cuff, single hose, adult, 6-7
 M4555B5 Cuff, single hose, adult, 6-8
 M4556A Cuff, single hose, adult, 6-4
 M4556B Cuff, single hose, adult, 6-7
 M4556B5 Cuff, single hose, adult, 6-8
 M4557A Cuff, single hose, large adult, 6-4
 M4557B Cuff, single hose, large adult, 6-7
 M4557B5 Cuff, single hose, large adult, 6-8
 M4558A Cuff, single hose, large adult extra-long, 6-4

M4558B Cuff, single hose, large adult extra-long, 6-7
 M4558B5 Cuff, single hose, large adult extra-long, 6-8
 M4559A Cuff, single hose, thigh, 6-4
 M4559B Cuff, single hose, thigh, 6-7
 M4559B5 Cuff, single hose, thigh, 6-8
 M4562A Cuff, double hose, infant, 6-6
 M4562B Cuff, double hose, infant, 6-10
 M4563B Cuff, double hose, pediatric, 6-10
 M4564A Cuff, double hose, small adult, 6-6
 M4564B Cuff, double hose, small adult, 6-10
 M4565A Cuff, double hose, adult, 6-6
 M4565B Cuff, double hose, adult, 6-10
 M4566A Cuff, double hose, adult, 6-6
 M4566B Cuff, double hose, adult X-long, 6-10
 M4567A Cuff, double hose, large adult, 6-6
 M4567B Cuff, double hose, large adult, 6-10
 M4568A Cuff, double hose, large adult extra-long, 6-6
 M4568B Cuff, double hose, large adult extra-long, 6-10
 M4569A Cuff, double hose, thigh, 6-6
 M4569B Cuff, double hose, thigh, 6-10

Tubing

989803136931 Interconnect tubing, VS1 adult/ped., 6-17
 989803136941 Interconnect tubing, VS1 neonatal, 6-22
 M1596B Interconnect tubing, neonatal, 6-22
 M1597B Interconnect tubing, neonatal, 6-22
 M1598B Interconnect tubing, 6-17
 M1599B Interconnect tubing, 6-17
 M3918A Interconnect tubing, 6-17

Adapters

NIBP Adapters, 6-19, 6-20

P**Paper****Cardiograph**

989803137011 StressVue paper, 2-11
 989803143031 StressVue paper, 2-11
 CBD20257 Stress chart paper, 2-10
 M1707A PW XL paper, 2-10
 M1708A PW XL paper, 2-10
 M1709A PW XL paper, 2-10
 M1710A PW XL paper, 2-10
 M1737A TraceView paper, 2-10
 M1738A TraceMaster paper, 2-10
 M2206A Anti-fade paper, 2-10
 M2207A Anti-fade paper, 2-10
 M2481A PageWriter Paper, 2-11
 M2483A PageWriter paper, 2-11
 M2485A PageWriter paper, 2-11
 M2486A Anti-fade paper, 2-11
 M3707A PageWriter Trim paper, 2-11
 M3708A PageWriter Trim paper, 2-11

Defibrillator

40453A Chemical/thermal paper, 2-9
 40457C Chemical/thermal paper, 2-9
 40457D Chemical/thermal paper, 2-9
 989803138171 HeartStart MRx paper, 2-9
 989803138181 HeartStart MRx paper, 2-9

Fetal

40470A chemical/thermal paper, 2-7
 9270-0484 chemical/thermal paper, 2-7
 9270-0485 chemical/thermal paper, 2-7
 9270-0630-050 Chemical/thermal paper, 2-7
 M1910A Chemical/thermal paper, 2-7
 M1911A Chemical/thermal paper, 2-7
 M1913A Chemical/thermal paper, 2-7

Imaging

40458A Imaging paper, 10-5
 40458A Paper, 2-12
 40479A Imaging paper, 10-5
 40479A Paper, 2-12

Monitoring

40469A Chemical/thermal paper, 2-6
 40477A Thermal array paper, 2-6
 40477B Thermal array paper, 2-6

989803136891 VS1, VM3-8 recorder paper, 2-6
 989803138131 ICG recorder paper, 2-6
 M1885A Chemical/thermal paper, 2-6
 M4816A Thermal array paper, 2-6
 M4817A Thermal array paper, 2-6
 PSE11268 Seiko 4-channel paper, 2-6

Recording Paper
 Selection Guide, 2-2

S

SpO₂ Sensor Cables

9898031 48221 LNCS adapter cable, 9-11
 989803148221 LNCS adapter cable, 9-6
 M1020-61100 LNOP adapter cable, 9-6, 9-11
 M1020-61102 LNOP adapter cable, 9-6
 M1900B adapter cable, 9-4
 M1900B Adapter Cables for Adhesive SpO₂ Sensors, 9-11
 M1940A adapter cable, 9-4
 M1941A extension cable, 9-4
 M1943A adapter cable, 9-4
 M1943A Reusable SpO₂ Sensor Extension Cable, 9-11
 M1943AL adapter cable, 9-4
 M1943AL Reusable SpO₂ Sensor Extension Cable, 9-11
 M1943NL adapter cable, 9-4
 M1943NL Reusable SpO₂ Sensor Extension Cable, 9-11
 M4780A VS1 adapter cable, 9-6
 M4787A Extension cable, Nellcor, 9-6

SpO₂ Sensors

9898031 40331 Masimo LNOP DCIP reusable, adult, 9-5
 9898031 48241 Masimo LNCS Pdt, pediatric, 9-9
 9898031 48251 Masimo LNCS, Inf-L, 9-9
 9898031 48261 Masimo LNCS Neo, 9-9
 9898031 48271 Masimo LNCS Neo-L, 9-9
 989803140231 Masimo LNOP Adt, adult, 9-8
 989803140261 Masimo LNOP Pdt, pediatric, 9-8
 989803140271 Masimo LNOP Neo, 9-8
 989803140281 Masimo LNOP SoftTouch NeoPt, 9-8
 989803140291 Masimo LNOP Neo-L, 9-8
 989803140301 Masimo LNOP SoftTouch Neo Pt-L, 9-8
 989803140311 Masimo LNOP, Inf-L, 9-8
 989803140321 Masimo LNOP DCI reusable, adult, 9-5
 989803140341 Masimo LNOP TC-I reusable, ear, 9-5
 989803140351 LNOP replacement poseys, 9-8
 989803140361 LNOP replacement tape, 9-8
 989803148231 Masimo LNCS Adt, adult, 9-9
 989803148281 Masimo LNCS DC-I reusable, adult, 9-5
 989803148291 Masimo LNCS DC-IP reusable, pedi, 9-5
 989803148301 Masimo LNCS TC-I reusable, adult, 9-5
 989803148311 Masimo LNCS TF-I reusable, adult, 9-5
 M1131A Adult/pediatric disposable SpO₂ sensor, 9-7
 M1132A Infant disposable SpO₂ sensor, 9-7
 M1133A Neonatal disposable SpO₂ sensor, 9-7
 M1191A Reusable Adult finger SpO₂ sensor, 9-2
 M1191AL Reusable Adult finger SpO₂ sensor, 9-2
 M1191B Reusable Adult finger SpO₂ sensor, 9-2
 M1191BL Reusable Adult finger SpO₂ sensor, 9-2
 M1191T Reusable, adult SpO₂ sensor, 9-3
 M1192A Reusable, Pediatric/Adult finger SpO₂ sensor, 9-2
 M1192T Reusable, pediatric/adult, 9-3
 M1193A Reusable, Neonatal foot/hand SpO₂ sensor, 9-2
 M1193T Reusable, Neonatal foot/hand, 9-3
 M1194A Reusable, Pediatric/Adult ear SpO₂ sensor, 9-2
 M1195A Reusable, Infant finger/toe SpO₂ sensor, 9-2
 M1196A Reusable, Adult finger clip, 9-2
 M1196T Reusable, adult finger clip, 9-3
 M1627A velcro strap, 9-4
 M1901B Sensor; neonatal foot, 9-10
 M1902B Sensor; infant digit, 9-10
 M1903B Sensor; pediatric digit, 9-10
 M1904B Sensor; adult digit, 9-10
 M4789A Sensor; adult reusable, Nellcor, 9-6

T

Temperature Probes

Disposable

21082A Temperature probe ext. cable, 7-5
 21082B Temperature probe ext. cable, 7-5
 21090A Temperature probe, 12 FR, 7-2
 21091A Temperature probe, skin surface, 7-3
 21093A Temperature probe, esophageal, 7-3
 21094A Temperature probe, esophageal, 7-3
 21095A Temperature probe, esophageal, 7-3
 21096A Temperature probe, Foley, 7-5
 21097A Temperature probe, Foley, 7-5
 M1837A Temperature probe, 9 FR, 7-2
 M2255A Temperature probe, Foley, 7-5

Reusable

21075A Temperature probe, esophageal/rectal, 7-6
 21076A Temperature probe, infant esophageal/rectal, 7-6
 21078A Temperature probe, skin, 7-6
 989803136901 VS1, oral, 7-7
 989803136911 VS1, rectal, 7-7
 989803136921 VS1 probe covers, 7-7
 989803143381 VM4/VS3, oral, 7-8
 989803143391 VM4/VS3, rectal, 7-8
 M3916A A3 Temperature probe, skin, 7-6
 M3917A A3 Temp probe, esophageal/rectal, 7-6
 M4821A A1/C1 Temperature probe, oral, 7-7
 M4822A A1/C1 Temperature probe, rectal, 7-7
 M4823A A1/C1 Temperature probe covers, 7-7
 M4823A Temp Probe Covers, VM4/VS3, 7-8

U

Ultrasound Imaging Supplies, 10-2

13920B VHS tape, 1/2" industrial grade, 10-2
 13921B VHS tape, 1/2" super VHS, 10-2
 21110A TEE transducer infection basin and lid, 10-3
 40483A Transmission gel, 10-2
 40483B Transmisison gel, 10-2
 40487A Transducer sheath kit, 10-3
 M1828A TEE bite guard, adult, 10-3
 M2203A MiniTEE bite guard, 10-4
 M2243A TEE transducer protector, 10-4
 M2273A TEE Tip protector, 10-3
 M4604A Omni III TEE Tip Protector, 10-4

Y

YC Carrying case, hard plastic waterproof shell